

**AGREEMENT FOR STORM WATER SYSTEM MAINTENANCE
BETWEEN ROCHESTER KM PARTNERS, LLC AND THE CITY OF ROCHESTER HILLS**

**AGREEMENT FOR
STORM WATER SYSTEM MAINTENANCE**

This Agreement is made on AUGUST 8, 2018, by Rochester KM Partners LLC, a Michigan Limited Liability Company, whose address is 6960 Orchard Lake Road, Suite 300, West Bloomfield, MI 48322 ("Owner"), and the CITY OF ROCHESTER HILLS (the "City"), whose address is 1000 Rochester Hills Drive, Rochester Hills, MI 48309.

WHEREAS, Owner owns and proposes to develop the real property legally described on Exhibit A attached hereto (the "Property"); and

WHEREAS, the proposed development of the Property will alter the natural flow of surface and storm water drainage; and

WHEREAS, Owner has proposed, and the City has approved, a storm water drainage and detention system (the "System") comprised of storm water detention and water quality treatment facilities, storm sewer pipe, catch basins, manholes for the Property as described and depicted in the Storm Water System Plan attached as Exhibit B; and

WHEREAS, the parties will benefit from the proper operation, use and maintenance of the System and enter into this agreement to provide for the same.

THEREFORE, the parties agree:

1. Use of the System:

Components of the System, including any and all water conveyance, detention and water quality treatment facilities, storm sewer pipe, catch basins, manholes, shall be used solely for the purpose of conveying, detaining and treating storm and surface drainage on the property until such time as: (i) The City determines and notifies Owner or Owner's successors, grantees or assigns, in writing, that it is no longer necessary to convey, detain or treat the storm and surface drainage; and (ii) An adequate alternative for conveying, detaining and treating storm and surface drainage has been provided which is acceptable to the City and which includes the granting of any easements to the City or third parties as may be required or necessary for the alternative drainage system.

2. Maintenance:

A. Owner shall be responsible for the proper maintenance, repair and replacement of the System and all parts thereof as detailed in the Maintenance Plan attached as Exhibit C.

B. Proper maintenance of the System shall include, but is not limited to: (i) Removing accumulated sediment, trash and debris; (ii) Maintaining storm sewer and structures; (iii) Controlling the effects of erosion; (iv) Inspection of storm sewer structures and pipes for structural integrity; (v) Inspection and cleaning of the storm sewer and catch basins upstream from the detention system; and (vi) Any other maintenance that is reasonable and necessary to facilitate and continue the proper operation and use of the System.

3. Action by City:

If, at any time, Owner or Owner's successors, grantees or assigns neglect or fail to properly maintain the System or any part thereof, the City may notify Owner or Owner's successors, grantees or assigns. The notice shall be in writing and shall list and describe maintenance deficiencies and demand that

they be corrected within thirty (30) days after receipt of such notice.

The notice shall further specify a date and place for a hearing to be held at least fourteen (14) days after the date of the notice before the City Council, or such other board or official as the City Council may designate. At the hearing, the City Council (or other designated board or official) may affirm or modify the list and description of maintenance deficiencies and, for good cause shown, shall extend the time for the deficiencies to be corrected.

Thereafter, if the maintenance deficiencies are not corrected within the time allowed, the City may undertake the necessary corrective actions, and the City may maintain the System for up to one (1) year. Such maintenance of the System by the City shall not be construed to be a trespass or a taking of the Property, nor shall the City's actions vest in the public any right to enter or use the Property. Thereafter, if Owner or Owner's successors, grantees or assigns do not properly maintain the System, the City may, after providing similar written notice, schedule and hold another hearing to determine whether the City should maintain the System for another year, and subject to a similar notice, hearing and determination in subsequent years.

In the event the City reasonably determines an emergency condition caused by or relating to the System exists which threatens the public health, safety or general welfare, the City shall have the right to immediately and without notice enter the Property and undertake appropriate corrective action.

Except in cases of emergency, the City shall provide written notice to Owner no less than twenty-four (24) hours prior to any entry upon the Property. All work performed by the City hereunder shall be performed in a prompt and expeditious manner, and in a manner that minimizes disruption of the operation of the Property. Without the prior written consent of the Owner, the City shall not place on or store any materials on the Property.

4. Charges to Take Corrective Actions:

The City shall charge to the current owner of the Property the cost of maintenance or other corrective action undertaken by the City in the event the City exercises its rights under Section 3 of this Agreement, plus a ten percent (10%) administrative fee. If not paid within thirty (30) days after receipt of a written invoice from the City for same, the City may place such charges on the City's tax roll, which charges shall be a lien on the real property and shall be collectable and enforceable in the same manner general property taxes are collected and enforced.

5. Notice:

Any notices required under this agreement shall be sent by certified mail to the address for each party set forth below, or to such other addresses as such party may notify the other parties in writing:

To Rochester KM Partners LLC: 6960 Orchard Lake Road, Suite 300
West Bloomfield, MI 48322

To the City: City Clerk
City of Rochester Hills
1000 Rochester Hills Drive
Rochester Hills, MI 48309

6. Successors and Assigns:

This agreement shall bind and inure to the benefit of the parties and their respective successors, grantees and assigns. The benefits, burdens, rights, obligations and responsibilities hereunder shall run with the land and shall bind all current and future owners of the Property and any divisions thereof. Any owner of the Property shall be relieved of any obligation hereunder upon conveyance of the Property to a third party.

7. **Recording of Agreement:**

This agreement shall be recorded at the Oakland County Register of Deeds.

[Remainder of the page intentionally left blank; signatures follow]

IN WITNESS WHEREOF, the parties have executed this Agreement on the date set forth above.

OWNER:

ROCHESTER KM PARTNERS LLC, a
Michigan Limited Liability Company

By: *Craig H. Singer*

Craig H. Singer, Member

STATE OF MICHIGAN
COUNTY OF *Oakland*

This agreement was acknowledged before me on *August 8, 2018*, by *Craig H. Singer* the
member, of Rochester KM Partners LLC, a Michigan Limited Liability
Company, on its behalf.

Sheri L. Dennis
SHERI L. DENNIS, Notary public
Oakland County, Michigan
My commission expires: _____

SHERI DENNIS
Notary Public - State of Michigan
County of Oakland
My Commission Expires *Mar 20, 2024*
Acting in the County of *Oakland*

CITY:

CITY OF ROCHESTER HILLS

By: _____
Bryan Barnett, Mayor

By: _____
Tina Barton, Clerk

STATE OF MICHIGAN
COUNTY OF OAKLAND

This agreement was acknowledged before me on _____, by Bryan Barnett, Mayor, and Tina Barton, Clerk, of the City of Rochester Hills, on behalf of the City.

Drafted By:
Emil Bunek, PE
PEA, Inc.
2430 Rochester Ct., Suite 100
Troy, MI 48083

, Notary public
County, Michigan
My commission expires: _____

When Recorded Return to:
City Clerk
City of Rochester Hills
1000 Rochester Hills Drive
Rochester Hills, MI 48309

John Staraw
Approved 8/13/18

**EXHIBIT A
LEGAL DESCRIPTION**

LEGAL DESCRIPTION

(Per PEA ALTA 2001-186, Dated 07-13-01)

Land located in the City of Rochester Hills, County of Oakland, and State of Michigan:

Part of the Northeast 1/4 of Section 22, T.3N., R.11E., City of Rochester Hills, Oakland County, Michigan, more particularly described as follows:
Commencing at the Northeast corner of said Section 22; thence along the North line of said Section 22, N89°05'58"W, 1045.00 feet; thence S00°59'40"W (recorded as S00°59'59"W), 60.00 feet to a point on the South Right-of-Way line of Avon Road, said point also being the **Point of Beginning**; thence along said South Right-of-Way line, S89°05'58"E, 577.00 feet; thence S00°59'40"W (recorded as S00°59'59"W), 180.00 feet; thence S89°05'58"E, 393.00 feet to a point on the West Right-of-Way line of Rochester Road; thence along said West Right-of-Way line, S00°59'40"W (recorded as S00°59'59"W), 475.00 feet; thence N89°05'58"W, 970.00 feet; thence N00°59'40"E (recorded as N00°59'59"E), 655.00 feet to the **Point of Beginning**, containing 12.962 acres and subject to any easements or restrictions of record.

Scott W.
Approved 8/9/18



PEA, Inc.

2430 Rochester Ct, Ste 100
Troy, MI 48063-1872
t: 248.689.9090
f: 248.689.1044
www.peainc.com

CLIENT: FIRST HOLDING MANAGEMENT 6960 ORCHARD LAKE ROAD WEST BLOOMFIELD, MI 48322	SCALE: N/A	JOB No: 2016-367
	DATE: 07-24-18	DWG. No: 1 of 1

EXHIBIT B
STORM SYSTEM AND DETENTION MAINTENANCE AGREEMENT

S. ROCHESTER ROAD
(VARIABLE WIDTH)

PRE-TREATMENT
STRUCTURE
(TS 4)

W. AVON ROAD
(60' 1/2 WIDTH)

OVERALL PARCEL
TAX ID.
15-22-226-014
(±12.962 ACRES)

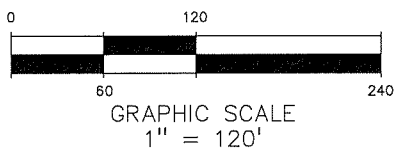
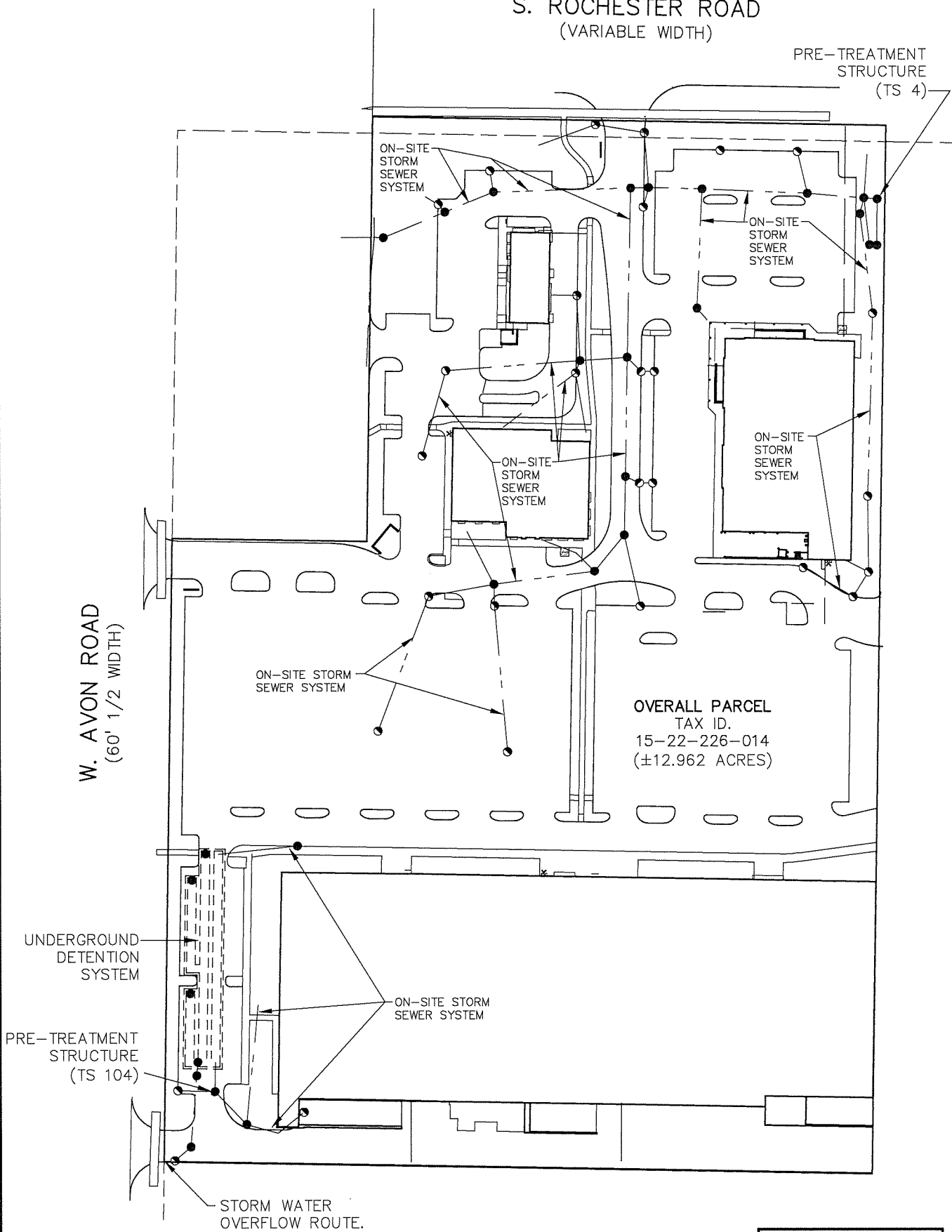

*OK
ARS 8/21/18*

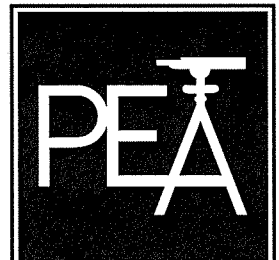

PEA, Inc.

2430 Rochester Ct, Ste 100
Troy, MI 48063-1872
t: 248.689.9090
f: 248.689.1044
www.peainc.com

REV: 08-17-18

CLIENT:
FIRST HOLDING MANAGEMENT
6960 ORCHARD LAKE ROAD
WEST BLOOMFIELD, MI 48322

SCALE: 1" = 120'

JOB No: 2016-367

DATE: ~~07-24-18~~

DWG. No: 1 of 1

EXHIBIT 'C'

OPERATIONS AND MAINTENANCE MANUAL

**WINCHESTER DISTRICT
STORMWATER MAINTENANCE PLAN
ROCHESTER HILLS, MICHIGAN**

PROPERTY OWNER:
Rochester KM Partners LLC
6960 Orchard Lake Road, Suite 300
West Bloomfield, MI 48322
Phone: 248-593-3835
Contact: Mr. Craig Singer

Prepared by:
PEA, Inc
2430 Rochester Court, Suite #100
Troy, Michigan, 48083-1872
Phone: (248) 689-9090
Contact: Emil Bunek, PE

July 1, 2018

*JK
ARS 8/21/18*

OPERATION AND MAINTENANCE MANUAL

INTRODUCTION:

This manual identifies the ownership, operation and maintenance responsibilities for all stormwater management systems including the treatment and detention basins, underground storm sewer system as incorporated into and detailed on the approved Construction Plans as prepared by PEA, Inc. In order to comply with the local best management practices (BMP) and requirements, this manual should serve as a minimum performance standard. This manual should be retained intact and read in its entirety by all parties responsible for the operations and maintenance of the on-site BMP's.

OWNER:

Mr. Craig Singer
Rochester KM Partners LLC
6960 Orchard Lake Road, Suite 300
West Bloomfield, MI 48322
Phone: 248-593-3835

PROPERTY INFORMATION:

This Operations and Maintenance Manual covers the storm water systems located at the following subject property:

LEGAL DESCRIPTION:

(see Exhibit 'A' of the Storm Water Maintenance Agreement)

STORMWATER MAINTENANCE EXHIBIT:

Exhibit 'B' of the Storm Water Maintenance Agreement is the Storm Water System Plan which provides a clear presentation of all components of the storm water system. This system is subject to the long-term operation and maintenance responsibilities detailed in this manual. The system includes:

- Storm sewer pipes
- Storm sewer structures (manholes, inlets, catch basins etc.)
- Outlet control structures
- Swales
- Pre-Treatment Device (CDS) *or (Vortechs)*

INSPECTIONS:

The frequency of system inspections outlined in the manual and attached exhibits should be considered the minimum, if no events warrant additional inspections. The frequency of inspections should be fine-tuned over time as system specific conditions are better known and the rate at which certain maintenance operations need to be performed is better understood. Maintenance Inspection Checklists are provided for each of the BMP's in this system. Inspections should be performed by personnel responsible for maintenance and may need to be certified for confined space entry, depending on the component being inspected. Operation of the detention system, outlet control structures and pre-treatment devices may need to be inspected by a practicing civil engineer familiar with their operation.

Records of all routine inspections and any work performed on the system for maintenance, repair or replacement should be maintained by the owner and kept for a minimum of ten (10) years. A copy of all records should be provided to the City of Rochester Hills Engineering Division. The records should include this manual, all inspection sheets, approved construction plans and as-built documents, a maintenance log of work performed to the system(s) and contact

information for the system inspector, civil engineer, landscape architect, geotechnical engineer and contractor involved with the system.

STORM WATER SYSTEMS MAINTENANCE:

Regular inspection and maintenance of BMP's are necessary if these facilities are to consistently perform up to expectations. Stormwater systems are expected to perform quality and quantity control functions as long as the land use they serve exists. Failure to maintain these systems can create the following adverse impacts:

- Increased pollutants to surrounding surface water features
- Potential loss of life or property resulting from catastrophic failure of the facility
- Aesthetic or nuisance conditions, such as mosquitoes or reduced property values due to a degraded facility appearance.

Most of these impacts can be avoided through proper and timely inspection and maintenance. A major concern associated with these impacts is the general public's expectations related to the quality of life provided, in part, by construction of these systems. Inadequate maintenance means the general public may have a false sense of security. The most common cause of stormwater system failure is the lack of adequate and proper operation, inspection, maintenance and management.

Good design and construction can reduce subsequent maintenance needs and costs, but they can not eliminate the need for maintenance altogether. Maintenance requires a long term commitment of time, money, personnel and equipment. Monitoring the overall performance of the stormwater management system is a major aspect of any maintenance program.

The maintenance responsibilities for these systems lie with the current property owner and transfer with the property in perpetuity. If maintenance of the system is not performed, the City of Rochester Hills reserves the right to enter the property and perform all necessary work at the property owners' cost. Refer to the *Agreement for Storm Water System Maintenance* for additional details.

General Maintenance Items:

Parking Lot Sweeping:

Routine sweeping of all paved surfaces provides a more attractive appearance and removes accumulations of sediment and trash that tend to migrate into stormwater management systems during rainfall events. Parking lot sweeping should be performed quarterly or as necessary to limit sediment and trash build-up.

Grass Mowing and Maintenance:

Mowing requirements at a facility should be designed to the specific site conditions, grass types and seasonal variations in climate. Grassed areas require periodic fertilizing, de-thatching and soil conditioning in order to maintain healthy growth. Provisions will need to be made to reseed and reestablish grass cover in areas damaged by sediment accumulation, stormwater flow, erosion or other causes. Dead turf will need to be replaced after being discovered. Inspection of the grass areas and other landscaping features should be made annually.

Trash and Debris Removal:

Removal of trash and debris from all areas of the property should be performed monthly. Removal of these items will prevent damage to vegetated areas and eliminate their potential to inhibit the operation of any of the stormwater management systems. Sediment, debris and trash that are removed and collected should be disposed of according to local, State and Federal regulations at suitable disposal and/or recycling centers.

Stormwater System Maintenance Items:

The following narratives give an overview of the maintenance requirements of the different components of the stormwater system. The inspection checklists attached to this report offer a more complete listing of what should be inspected, when inspection should occur and the likely frequency of maintenance activities.

Storm Sewer and Structures:

Catch basins, inlets, manholes and sewer pipes should be inspected to check for sediment accumulation and clogging, floatable debris, dead vegetation etc. The structures and sewers should also be observed during a wet weather event to ensure their proper operation. Accumulated sediment and debris should be removed on an annual basis or as needed based on observed conditions. Structural repairs or maintenance should occur as needed based on observed conditions such as cracks, spalling, joint failure, leakage, misalignment or settlement of structures. A civil engineer should be retained if problems are thought to exist.

Swales:

The swales should be kept free of trash, debris or any other foreign matter that would inhibit drainage. The swale yard drain structures should be checked for structural integrity as mentioned above for the storm sewer structures, and any visible signs of erosion or flow bypassing the structure.

Stormwater Pre-Treatment Devices:

Refer to the attached maintenance manuals from the manufacturer for all inspection and maintenance requirements for the pre-treatment structures.

The following pages include inspection checklists for the various devices and components listed above as well as the manufacturer's manuals for the stormwater pre-treatment structures.

EXHIBIT C

STORMWATER MANAGEMENT SYSTEM – PERMANENT MAINTANANCE

DATE/TIME OF INSPECTION: _____

INSPECTOR: _____

STORMWATER MANAGEMENT SYSTEM MAINTENANCE TASKS AND SCHEDULE

POST CONSTRUCTION

MAINTENANCE ACTIVITIES MONITORING/INSPECTION	SYSTEM COMPONENTS				FREQUENCY	COMMENTS
	Catch Basins, Inlets, Manholes, and Outlet Control Structures	Storm Sewer & Detention Pipes		Swale		
Inspect for Sediment Accumulation	X	X	X		Annually	
Inspect for Floatables, dead vegetation and debris	X	X	X		Annually	
Inspect for erosion				X	Annually	
Inspect all components during wet weather and compare to as-built plans	X	X			Annually	
Inspect inside of structures and pipes for cracks, spalling, joint failure, settlement, sagging and misalignment.	X	X			Annually	
Inspect for invasive plant species					Annually	
PREVENTATIVE MAINTENANCE						
Remove accumulated sediment	X	X	X		Annually or as needed	
Remove floatables, dead vegetation and debris	X	X	X		Annually or as needed	
Professional application of herbicide for invasive species that may be present					Annually or as needed	
REMEDIAL ACTIONS						
Repair/stabilize areas of erosion				X	As Needed	
Structural Repairs	X	X			As Needed	
Make adjustments/repairs to ensure proper functioning	X	X	X		As Needed	

SUMMARY:

INSPECTORS REMARKS: _____

OVERALL CONDITION OF FACILITY: _____

RECOMMENDED ACTIONS NEEDED: _____

DATES ANY MAINTENANCE MUST BE COMPLETED BY: _____

OK ARS 08/21/18

REV: 08-17-18



PEA, Inc.
 2430 Rochester Ct, Ste 100
 Troy, MI 48063-1872
 t: 248.689.9090
 f: 248.689.1044
 www.peainc.com

CLIENT:
FIRST HOLDING MANAGEMENT
 6960 ORCHARD LAKE ROAD
 WEST BLOOMFIELD, MI 48322

SCALE: N/A JOB No: 2016-367
 DATE: ~~07-24-18~~ DWG. No: 1 of 1

CDS Guide

Operation, Design, Performance and Maintenance



CDS®

Using patented continuous deflective separation technology, the CDS system screens, separates and traps debris, sediment, and oil and grease from stormwater runoff. The indirect screening capability of the system allows for 100% removal of floatables and neutrally buoyant material without blinding. Flow and screening controls physically separate captured solids, and minimize the re-suspension and release of previously trapped pollutants. Inline units can treat up to 6 cfs, and internally bypass flows in excess of 50 cfs (1416 L/s). Available precast or cast-in-place, offline units can treat flows from 1 to 300 cfs (28.3 to 8495 L/s). The pollutant removal capacity of the CDS system has been proven in lab and field testing.

Operation Overview

Stormwater enters the diversion chamber where the diversion weir guides the flow into the unit's separation chamber and pollutants are removed from the flow. All flows up to the system's treatment design capacity enter the separation chamber and are treated.

Swirl concentration and screen deflection force floatables and solids to the center of the separation chamber where 100% of floatables and neutrally buoyant debris larger than the screen apertures are trapped.

Stormwater then moves through the separation screen, under the oil baffle and exits the system. The separation screen remains clog free due to continuous deflection.

During the flow events exceeding the treatment design capacity, the diversion weir bypasses excessive flows around the separation chamber, so captured pollutants are retained in the separation cylinder.

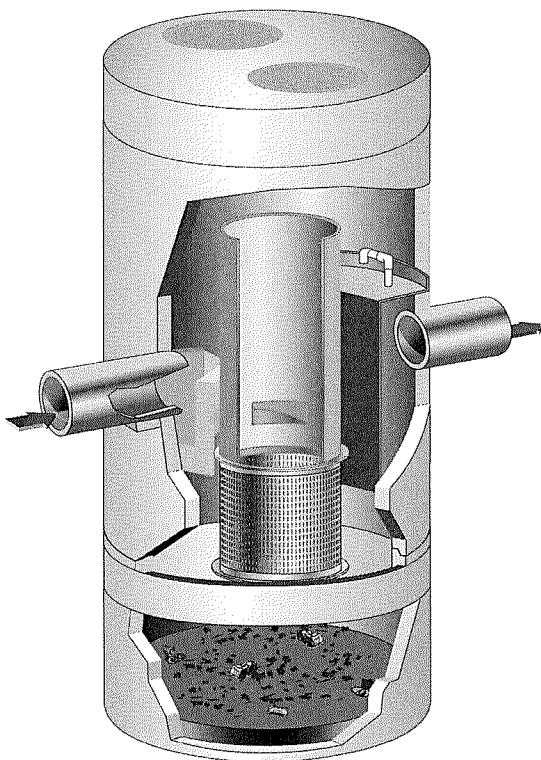

Design Basics

There are three primary methods of sizing a CDS system. The Water Quality Flow Rate Method determines which model size provides the desired removal efficiency at a given flow rate for a defined particle size. The Rational Rainfall Method™ or the Probabilistic Method is used when a specific removal efficiency of the net annual sediment load is required.

Typically in the United States, CDS systems are designed to achieve an 80% annual solids load reduction based on lab generated performance curves for a gradation with an average particle size (d50) of 125 microns (μm). For some regulatory environments, CDS systems can also be designed to achieve an 80% annual solids load reduction based on an average particle size (d50) of 75 microns (μm) or 50 microns (μm).

Water Quality Flow Rate Method

In some cases, regulations require that a specific treatment rate, often referred to as the water quality design flow (WQQ), be treated. This WQQ represents the peak flow rate from either an event with a specific recurrence interval, e.g. the six-month storm, or a water quality depth, e.g. 1/2-inch (13 mm) of rainfall.

The CDS is designed to treat all flows up to the WQQ. At influent rates higher than the WQQ, the diversion weir will direct most flow exceeding the WQQ around the separation chamber. This allows removal efficiency to remain relatively constant in the separation chamber and eliminates the risk of washout during bypass flows regardless of influent flow rates.

Treatment flow rates are defined as the rate at which the CDS will remove a specific gradation of sediment at a specific removal efficiency. Therefore the treatment flow rate is variable, based on the gradation and removal efficiency specified by the design engineer.

Rational Rainfall Method™

Differences in local climate, topography and scale make every site hydraulically unique. It is important to take these factors into consideration when estimating the long-term performance of any stormwater treatment system. The Rational Rainfall Method combines site-specific information with laboratory generated performance data, and local historical precipitation records to estimate removal efficiencies as accurately as possible.

Short duration rain gauge records from across the United States and Canada were analyzed to determine the percent of the total annual rainfall that fell at a range of intensities. US stations' depths were totaled every 15 minutes, or hourly, and recorded in 0.01-inch increments. Depths were recorded hourly with 1-mm resolution at Canadian stations. One trend was consistent at all sites; the vast majority of precipitation fell at low intensities and high intensity storms contributed relatively little to the total annual depth.

These intensities, along with the total drainage area and runoff coefficient for each specific site, are translated into flow rates using the Rational Rainfall Method. Since most sites are relatively small and highly impervious, the Rational Rainfall Method is appropriate. Based on the runoff flow rates calculated for each intensity, operating rates within a proposed CDS system are

determined. Performance efficiency curve determined from full scale laboratory tests on defined sediment PSDs is applied to calculate solids removal efficiency. The relative removal efficiency at each operating rate is added to produce a net annual pollutant removal efficiency estimate.

Probabilistic Rational Method

The Probabilistic Rational Method is a sizing program Contech developed to estimate a net annual sediment load reduction for a particular CDS model based on site size, site runoff coefficient, regional rainfall intensity distribution, and anticipated pollutant characteristics.

The Probabilistic Method is an extension of the Rational Method used to estimate peak discharge rates generated by storm events of varying statistical return frequencies (e.g. 2-year storm event). Under the Rational Method, an adjustment factor is used to adjust the runoff coefficient estimated for the 10-year event, correlating a known hydrologic parameter with the target storm event. The rainfall intensities vary depending on the return frequency of the storm event under consideration. In general, these two frequency dependent parameters (rainfall intensity and runoff coefficient) increase as the return frequency increases while the drainage area remains constant.

These intensities, along with the total drainage area and runoff coefficient for each specific site, are translated into flow rates using the Rational Method. Since most sites are relatively small and highly impervious, the Rational Method is appropriate. Based on the runoff flow rates calculated for each intensity, operating rates within a proposed CDS are determined. Performance efficiency curve on defined sediment PSDs is applied to calculate solids removal efficiency. The relative removal efficiency at each operating rate is added to produce a net annual pollutant removal efficiency estimate.

Treatment Flow Rate

The inlet throat area is sized to ensure that the WQQ passes through the separation chamber at a water surface elevation equal to the crest of the diversion weir. The diversion weir bypasses excessive flows around the separation chamber, thus preventing re-suspension or re-entrainment of previously captured particles.

Hydraulic Capacity

The hydraulic capacity of a CDS system is determined by the length and height of the diversion weir and by the maximum allowable head in the system. Typical configurations allow hydraulic capacities of up to ten times the treatment flow rate. The crest of the diversion weir may be lowered and the inlet throat may be widened to increase the capacity of the system at a given water surface elevation. The unit is designed to meet project specific hydraulic requirements.

Performance

Full-Scale Laboratory Test Results

A full-scale CDS system (Model CDS2020-5B) was tested at the facility of University of Florida, Gainesville, FL. This CDS unit was evaluated under controlled laboratory conditions of influent flow rate and addition of sediment.

Two different gradations of silica sand material (UF Sediment & OK-110) were used in the CDS performance evaluation. The particle size distributions (PSDs) of the test materials were analyzed using standard method "Gradation ASTM D-422 "Standard Test Method for Particle-Size Analysis of Soils" by a certified laboratory.

UF Sediment is a mixture of three different products produced by the U.S. Silica Company: "Sil-Co-Sil 106", "#1 DRY" and "20/40 Oil Frac". Particle size distribution analysis shows that the UF Sediment has a very fine gradation ($d_{50} = 20$ to $30 \mu\text{m}$) covering a wide size range (Coefficient of Uniformity, C averaged at 10.6). In comparison with the hypothetical TSS gradation specified in the NJDEP (New Jersey Department of Environmental Protection) and NJCAT (New Jersey Corporation for Advanced Technology) protocol for lab testing, the UF Sediment covers a similar range of particle size but with a finer d_{50} (d_{50} for NJDEP is approximately $50 \mu\text{m}$) (NJDEP, 2003).

The OK-110 silica sand is a commercial product of U.S. Silica Sand. The particle size distribution analysis of this material, also included in Figure 1, shows that 99.9% of the OK-110 sand is finer than 250 microns, with a mean particle size (d_{50}) of 106 microns. The PSDs for the test material are shown in Figure 1.

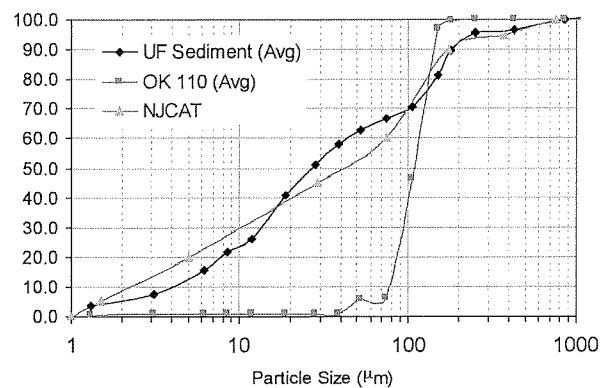

Figure 1. Particle size distributions

Tests were conducted to quantify the performance of a specific CDS unit (1.1 cfs (31.3-L/s) design capacity) at various flow rates, ranging from 1% up to 125% of the treatment design capacity of the unit, using the 2400 micron screen. All tests were conducted with controlled influent concentrations of approximately 200 mg/L. Effluent samples were taken at equal time intervals across the entire duration of each test run. These samples were then processed with a Dekaport Cone sample splitter to obtain representative sub-samples for Suspended Sediment Concentration (SSC) testing using ASTM D3977-97 "Standard Test Methods for Determining Sediment Concentration in Water Samples", and particle size distribution analysis.

Results and Modeling

Based on the data from the University of Florida, a performance model was developed for the CDS system. A regression analysis was used to develop a fitting curve representative of the scattered data points at various design flow rates. This model, which demonstrated good agreement with the laboratory data, can then be used to predict CDS system performance with respect

to SSC removal for any particle size gradation, assuming the particles are inorganic sandy-silt. Figure 2 shows CDS predictive performance for two typical particle size gradations (NJCAT gradation and OK-110 sand) as a function of operating rate.

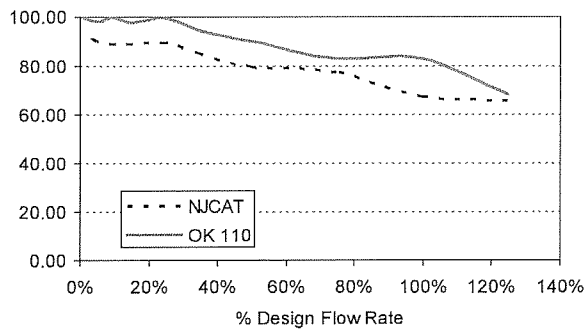

Figure 2. CDS stormwater treatment predictive performance for various particle gradations as a function of operating rate.

Many regulatory jurisdictions set a performance standard for hydrodynamic devices by stating that the devices shall be capable of achieving an 80% removal efficiency for particles having a mean particle size (d_{50}) of 125 microns (e.g. Washington State Department of Ecology — WASDOE - 2008). The model can be used to calculate the expected performance of such a PSD (shown in Figure 3). The model indicates (Figure 4) that the CDS system with 2400 micron screen achieves approximately 80% removal at the design (100%) flow rate, for this particle size distribution ($d_{50} = 125 \mu\text{m}$).

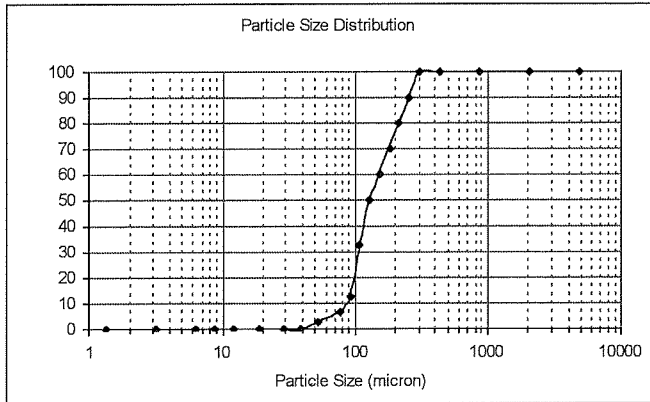

Figure 3. WASDOE PSD

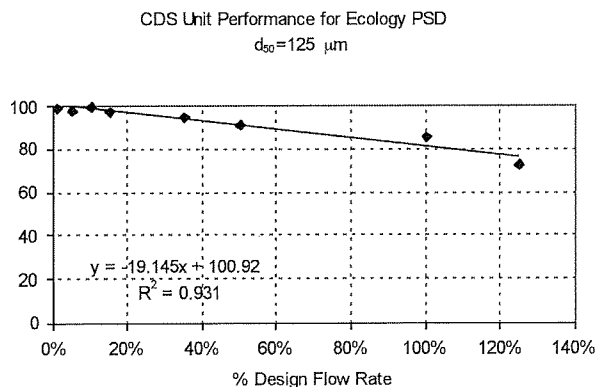

Figure 4. Modeled performance for WASDOE PSD.

Maintenance

The CDS system should be inspected at regular intervals and maintained when necessary to ensure optimum performance. The rate at which the system collects pollutants will depend more heavily on site activities than the size of the unit. For example, unstable soils or heavy winter sanding will cause the grit chamber to fill more quickly but regular sweeping of paved surfaces will slow accumulation.

Inspection

Inspection is the key to effective maintenance and is easily performed. Pollutant transport and deposition may vary from year to year and regular inspections will help ensure that the system is cleaned out at the appropriate time. At a minimum, inspections should be performed twice per year (e.g. spring and fall) however more frequent inspections may be necessary in climates where winter sanding operations may lead to rapid accumulations, or in equipment washdown areas. Installations should also be inspected more frequently where excessive amounts of trash are expected.

The visual inspection should ascertain that the system components are in working order and that there are no blockages or obstructions in the inlet and separation screen. The inspection should also quantify the accumulation of hydrocarbons, trash, and sediment in the system. Measuring pollutant accumulation can be done with a calibrated dipstick, tape measure or other measuring instrument. If absorbent material is used for enhanced removal of hydrocarbons, the level of discoloration of the sorbent material should also be identified



during inspection. It is useful and often required as part of an operating permit to keep a record of each inspection. A simple form for doing so is provided.

Access to the CDS unit is typically achieved through two manhole access covers. One opening allows for inspection and cleanout of the separation chamber (cylinder and screen) and isolated sump. The other allows for inspection and cleanout of sediment captured and retained outside the screen. For deep units, a single manhole access point would allow both sump cleanout and access outside the screen.

The CDS system should be cleaned when the level of sediment has reached 75% of capacity in the isolated sump or when an appreciable level of hydrocarbons and trash has accumulated. If absorbent material is used, it should be replaced when significant discoloration has occurred. Performance will not be impacted until 100% of the sump capacity is exceeded however it is recommended that the system be cleaned prior to that for easier removal of sediment. The level of sediment is easily determined by measuring from finished grade down to the top of the sediment pile. To avoid underestimating the level of sediment in the chamber, the measuring device must be lowered to the top of the sediment pile carefully. Particles at the top of the pile typically offer less resistance to the end of the rod than consolidated particles toward the bottom of the pile. Once this measurement is recorded, it should be compared to the as-built drawing for the unit to determine whether the height of the sediment pile off the bottom of the sump floor exceeds 75% of the total height of isolated sump.

Cleaning

Cleaning of a CDS system should be done during dry weather conditions when no flow is entering the system. The use of a vacuum truck is generally the most effective and convenient method of removing pollutants from the system. Simply remove the manhole covers and insert the vacuum hose into the sump. The system should be completely drained down and the sump fully evacuated of sediment. The area outside the screen should also be cleaned out if pollutant build-up exists in this area.

In installations where the risk of petroleum spills is small, liquid contaminants may not accumulate as quickly as sediment. However, the system should be cleaned out immediately in the event of an oil or gasoline spill. Motor oil and other hydrocarbons that accumulate on a more routine basis should be removed when an appreciable layer has been captured. To remove these pollutants, it may be preferable to use absorbent pads since they are usually less expensive to dispose than the oil/water emulsion that may be created by vacuuming the oily layer. Trash and debris can be netted out to separate it from the other pollutants. The screen should be cleaned to ensure it is free of trash and debris.

Manhole covers should be securely seated following cleaning activities to prevent leakage of runoff into the system from above and also to ensure that proper safety precautions have been followed. Confined space entry procedures need to be followed if physical access is required. Disposal of all material removed from the CDS system should be done in accordance with local regulations. In many jurisdictions, disposal of the sediments may be handled in the same manner as the disposal of sediments removed from catch basins or deep sump manholes. Check your local regulations for specific requirements on disposal.



CDS Model	Diameter		Distance from Water Surface to Top of Sediment Pile		Sediment Storage Capacity	
	ft	m	ft	m	yd3	m3
CDS2015-4	4	1.2	3.0	0.9	0.5	0.4
CDS2015	5	1.5	3.0	0.9	1.3	1.0
CDS2020	5	1.5	3.5	1.1	1.3	1.0
CDS2025	5	1.5	4.0	1.2	1.3	1.0
CDS3020	6	1.8	4.0	1.2	2.1	1.6
CDS3030	6	1.8	4.6	1.4	2.1	1.6
CDS3035	6	1.8	5.0	1.5	2.1	1.6
CDS4030	8	2.4	4.6	1.4	5.6	4.3
CDS4040	8	2.4	5.7	1.7	5.6	4.3
CDS4045	8	2.4	6.2	1.9	5.6	4.3

Table 1: CDS Maintenance Indicators and Sediment Storage Capacities

Note: To avoid underestimating the volume of sediment in the chamber, carefully lower the measuring device to the top of the sediment pile. Finer silty particles at the top of the pile may be more difficult to feel with a measuring stick. These finer particles typically offer less resistance to the end of the rod than larger particles toward the bottom of the pile.

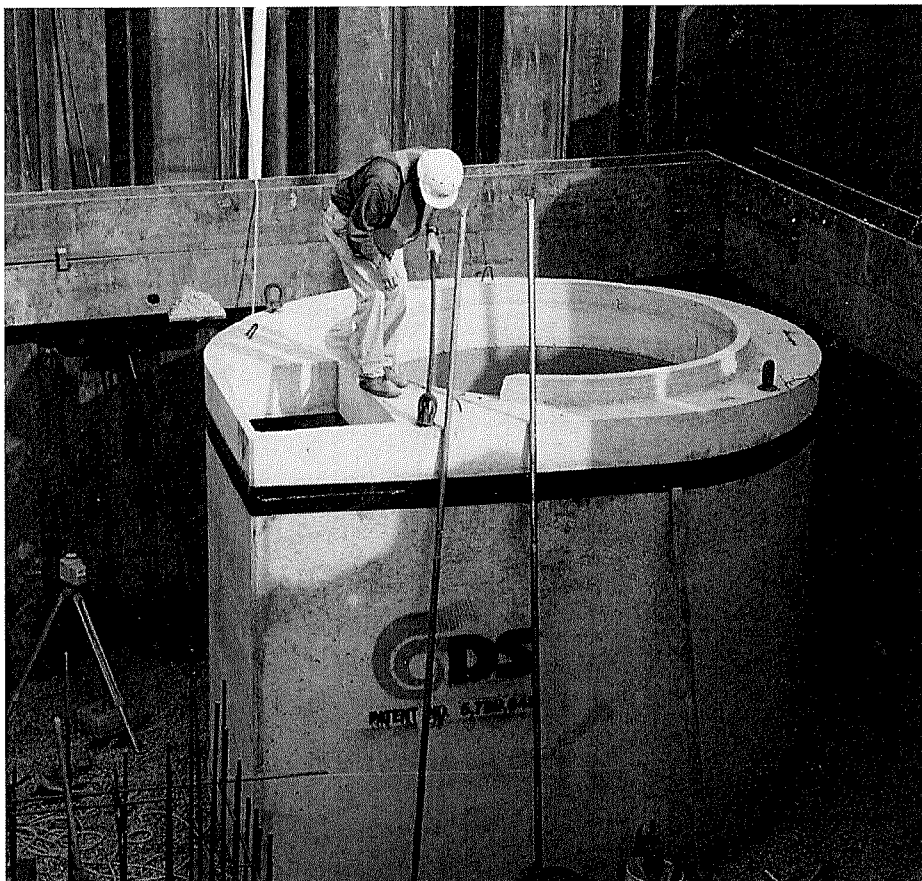

CDS Inspection & Maintenance Log

CDS Model: _____ Location: _____

Date	Water depth to sediment ¹	Floatable Layer Thickness ²	Describe Maintenance Performed	Maintenance Personnel	Comments

1. The water depth to sediment is determined by taking two measurements with a stadia rod: one measurement from the manhole opening to the top of the sediment pile and the other from the manhole opening to the water surface. If the difference between these measurements is less than eighteen inches the system should be cleaned out. **Note: To avoid underestimating the volume of sediment in the chamber, the measuring device must be carefully lowered to the top of the sediment pile.**
2. For optimum performance, the system should be cleaned out when the floating hydrocarbon layer accumulates to an appreciable thickness. In the event of an oil spill, the system should be cleaned immediately.

Support

- Drawings and specifications are available at www.ContechES.com/urbangreen.
- Site-specific design support is available from our engineers.



800.925.5240

www.ContechES.com/urbangreen

©2013 Contech Engineered Solutions LLC

Contech Engineered Solutions provides site solutions for the civil engineering industry. Contech's portfolio includes bridges, drainage, sanitary sewer, stormwater, earth stabilization and wastewater products. For information on other Contech division offerings, visit www.ContechES.com or call 800.338.1122

NOTHING IN THIS CATALOG SHOULD BE CONSTRUED AS AN EXPRESSED WARRANTY OR AN IMPLIED WARRANTY OF MERCHANTABILITY OR FITNESS FOR ANY PARTICULAR PURPOSE. SEE THE Contech STANDARD CONDITION OF SALES (VIEWABLE AT www.ContechES.com/COS) FOR APPLICABLE WARRANTIES AND OTHER IMPORTANT INFORMATION.

The product(s) described may be protected by one or more of the following US patents: 5,322,629; 5,624,576; 5,707,527; 5,759,415; 5,788,848; 5,985,157; 6,027,639; 6,350,374; 6,406,218; 6,641,720; 6,511,595; 6,649,048; 6,991,114; 6,998,038; 7,186,058; 7,296,692; 7,297,266; related foreign patents or other patents pending.

Vortechs[®] Guide Operation, Design, Performance and Maintenance

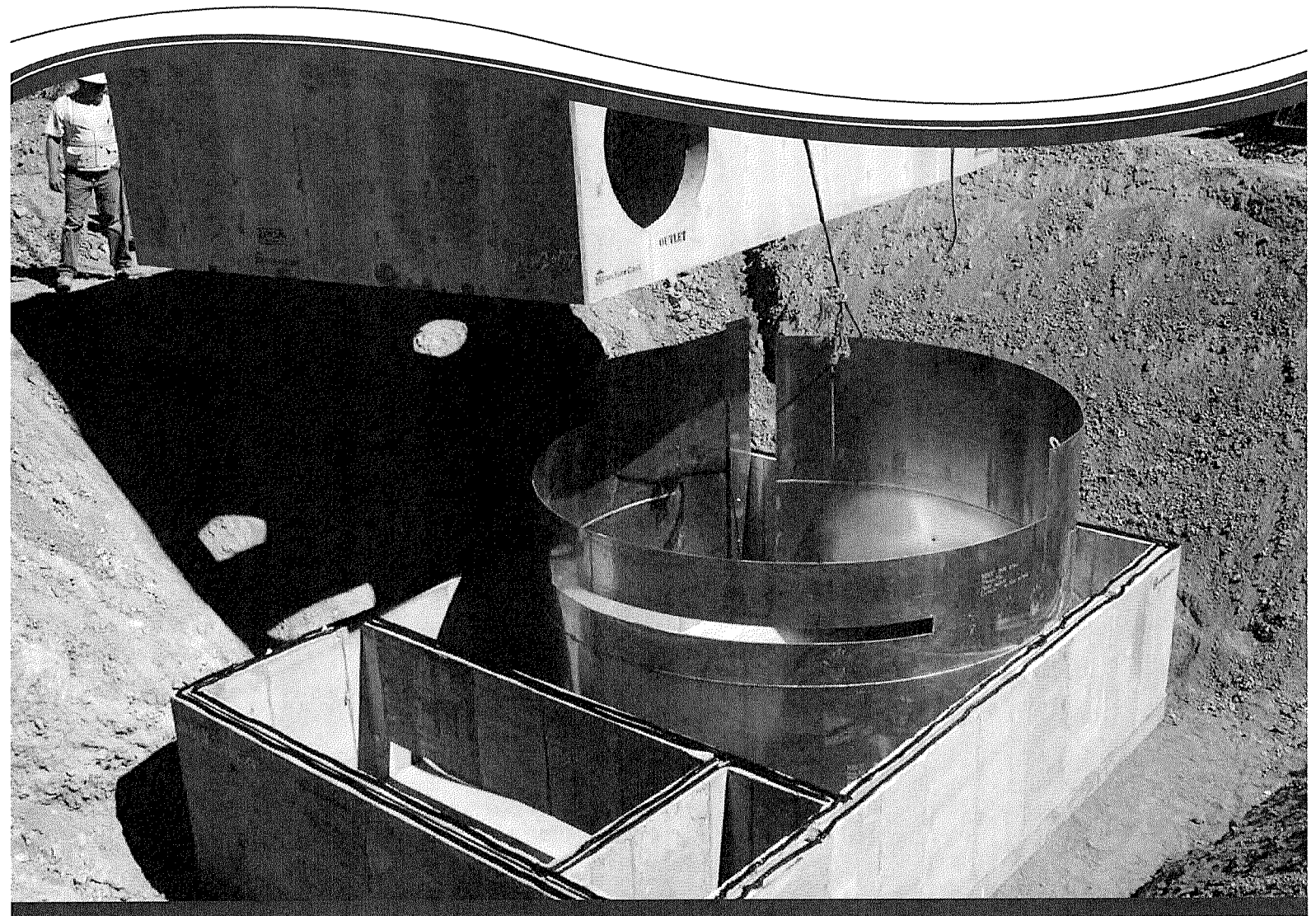

Vortechs®

The Vortechs system is a high-performance hydrodynamic separator that effectively removes finer sediment (e.g. 50-microns (μm), oil, and floating and sinking debris). The swirl concentration operation and flow controls work together to minimize turbulence and provide stable storage of captured pollutants. Precast models can treat peak design flows up to 30-cfs (850-L/s); cast-in-place models handle even greater flows. A typical system is sized to provide a specific removal efficiency of a predefined particle size distribution (PSD).

Operation Overview

Stormwater enters the swirl chamber inducing a gentle swirling flow pattern and enhancing gravitational separation. Sinking pollutants stay in the swirl chamber while floatables are stopped at the baffle wall. Vortechs systems are usually sized to efficiently treat the frequently occurring runoff events and are primarily controlled by the low flow control orifice. This orifice effectively reduces inflow velocity and turbulence by inducing a slight backwater that is appropriate to the site.

During larger storms, the water level rises above the low flow control orifice and begins to flow through the high flow control. Any layer of floating pollutants is elevated above the invert of the Floatables Baffle Wall, preventing release. Swirling action increases in relation to the storm intensity, while sediment pile remains stable. When the storm drain is flowing at peak capacity, the water surface in the system approaches the top of the high flow control. The Vortechs system will be sized large enough so that previously captured pollutants are retained in the system, even during these infrequent events.

As a storm subsides, treated runoff decants out of the Vortechs system at a controlled rate, restoring the water level to a dry-weather level equal to the invert of the inlet pipe. The low water level facilitates easier inspection and cleaning, and significantly reduces maintenance costs by reducing pump-out volume.

Design Basics

Each Vortechs system is custom designed based on site size, site runoff coefficient, regional precipitation intensity distribution, and anticipated pollutant characteristics. There are two primary methods of sizing a Vortechs system. The first is to determine which model size provides the desired removal efficiency at a given flow for a defined particle size or PSD. The second and more in depth method is the summation of Rational Rainfall Method™ which uses a summation process described below in detail and is used when a specific removal efficiency of the net annual sediment load is required.

Typically Vortechs systems are designed to achieve an 80% annual solids load reduction based on lab generated performance curves for either 50- μm particles, or a particle gradation found in typical urban runoff (see performance section of this manual for more information).

The Rational Rainfall Method™

Differences in local climate, topography and scale make every site hydraulically unique. It is important to take these factors into consideration when estimating the long-term performance of any stormwater treatment system. The Rational Rainfall Method combines site-specific information with laboratory generated performance data, and local historical precipitation records to estimate removal efficiencies as accurately as possible.

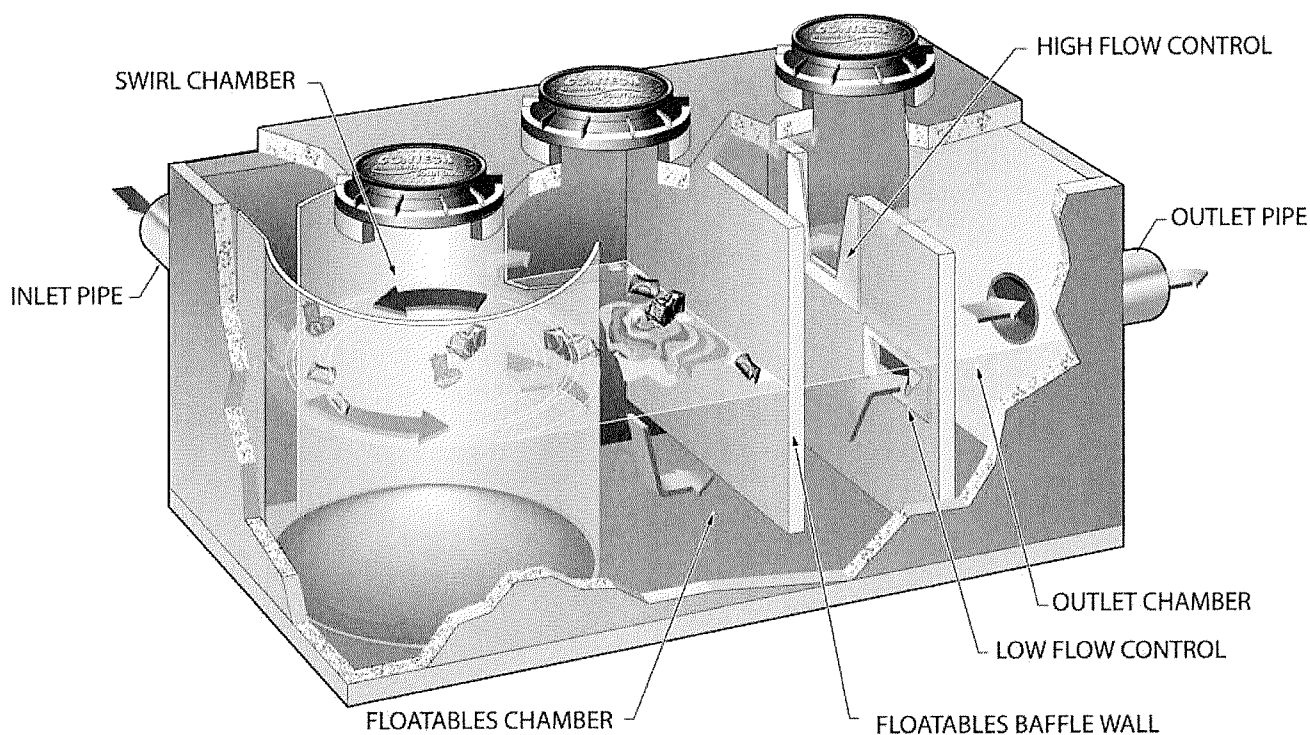

Short duration rain gauge records from across the United States and Canada were analyzed to determine the percent of the total annual rainfall that fell at a range of intensities. US stations' depths were totaled every 15 minutes or hourly and recorded in 0.01-inch increments. Depths were recorded hourly with 1-mm resolution at Canadian stations. One trend was consistent at all sites; the vast majority of precipitation fell at low intensities and high intensity storms contributed relatively little to the total annual depth.

These intensities, along with the total drainage area and runoff coefficient for each specific site, are translated into flow rates using the Rational Rainfall Method. Since most sites are relatively small and highly impervious, the Rational Rainfall Method is appropriate. Based on the runoff flow rates calculated for each intensity, operating rates within a proposed Vortechs system are determined. Performance efficiency curve determined from full scale laboratory tests on defined sediment PSDs is applied to calculate solids removal efficiency. The relative removal efficiency at each operating rate is added to produce a net annual pollutant removal efficiency estimate.

Once a system size is established, the internal elements of the system are designed based on information provided by the site engineer. Flow control sizes and shapes, sump depth, oil spill storage capacity, sediment storage volume and inlet and outlet orientation are determined for each system. In addition, bypass weir calculations are made for off-line systems.

Flow Control Calculations

Low Flow Control

The low flow control, or orifice, is typically sized to submerge the inlet pipe when the Vortechs system is operating at 20% of its treatment capacity. The orifice is typically a Cippoletti shaped aperture defined by its flat crest and sides which incline outwardly at a slope of 1 horizontal to 4 vertical.

$$Q_{\text{orifice}} = C_d \cdot A \cdot \sqrt{2gh}$$

Where:

Q_{orifice} = flow through orifice, cfs (L/s)

C_d = orifice coefficient of discharge = 0.56 (based on lab tests)

A = orifice flow area, ft² (m²) (calculated by orifice geometry)

h = design head, ft (m) (equal to the inlet pipe diameter)

g = acceleration due to gravity (32.2-ft/s² (9.81-m/s²))

The minimum orifice crest length is 3-in (76-mm) and the minimum orifice height is 4-in (102-mm). If flow must be restricted beyond what can be provided by this size aperture, a Fluidic-Amp™ HydroBrake flow control will be used. The HydroBrake allows the minimum flow constriction to remain at 3-in (76-mm) or greater while further reducing flow due to its unique throttling action.

High Flow Control

The high flow control, or weir, is sized to pass the peak system capacity minus the peak orifice flow when the water surface elevation is at the top of the weir. This flow control is also a Cippoletti type weir.

The weir flow control is sized by solving for the crest length and head in the following equation:

$$Q_{\text{weir}} = C_d \cdot L \cdot (h)^{3/2}$$

Where:

Q_{weir} = flow through weir, cfs (L/s)

C_d = Cippoletti weir coefficient = 3.37 (based on lab testing)

h = available head, ft (m) (height of weir)

L = design weir crest length, ft (m)

Bypass Calculations

In most all cases, pollutant removal goals can be met without treating peak flow rates and it is most feasible to use a smaller Vortechs system configured with an external bypass. In such cases, a bypass design is recommended by CONTECH Stormwater Solutions for each off-line system. To calculate the bypass capacity, first subtract the system's treatment capacity from the peak conveyance capacity of the collection system (minimum of 10-year recurrence interval). The result is the flow rate that must be bypassed to avoid surcharging the Vortechs system. Then use the following arrangement of the Francis formula to calculate the depth of flow over the bypass weir.

$$H = (Q_{\text{bypass}} / (C_d \cdot L))^{2/3}$$

Where:

H = depth of flow over bypass weir crest, ft (m)

Q_{bypass} = required bypass flow, cfs (L/s)

C_d = discharge coefficient = 3.3 for rectangular weir

L = length of bypass weir crest, ft

The bypass weir crest elevation is then calculated to be the elevation at the top of the Cippoletti weir minus the depth of flow.

Hydraulic Capacity

In the event that the peak design flow from the site is exceeded, it is important that the Vortechs system is not a constriction to runoff leaving the site. Therefore, each system is designed with enough hydraulic capacity to pass the 100-year flow rate. It is important to note that at operating rates above 100-gpm/ft² (68-Lps/m²) of the swirl chamber area (peak treatment capacity), captured pollutants may be lost.

When the system is operating at peak hydraulic capacity, water will be flowing through the gap over the top of the flow control wall as well as the orifice and the weir.

Performance

Full Scale Laboratory Test Results

Laboratory testing was conducted on a full scale Vortechs model 2000. The 150- μm curve demonstrates the results of tests using particles that passed through a 60-mesh sieve and were retained on a 100-mesh sieve. The 50- μm curve is based on tests of particles passing through a 200-mesh sieve and retained on a 400-mesh sieve (38- μm). A gradation with an average particle size (d50) of 80- μm , containing particles ranging from 38–500- μm in diameter was used to represent typical stormwater solids. (Table 1)

Particle Size Distribution (μm)	Percentage of Sample Make-Up
<63	42%
63 - 75	4%
75 - 100	9%
100 - 150	7%
150 - 250	11%
>250	27%

Table 1: Particle gradation of typical urban runoff used for efficiency curve

As shown, the Vortechs system maintains positive total suspended solids (TSS), defined by the tested gradations, removal efficiencies over the full range of operating rates. This allows the system to effectively treat all runoff from large, infrequent design storms, as well as runoff from more frequent low-intensity storms.

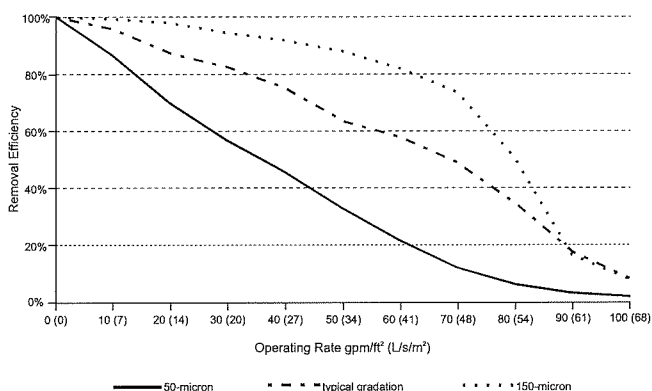

Figure 1: Vortechs model 2000 Removal Efficiencies

Typical Vortechs systems are designed to treat peak flows from 1.6-cfs (45-L/s) up to 30-cfs (850-L/s) online without the need for bypass. However, external bypasses can be configured to convey peak flows around the system if treatment capacity is exceeded. The system can also be configured to direct low flows from the last chamber of the system to polishing treatment when more stringent water quality standards are imposed. In all configurations, high removal efficiencies are achieved during the lower intensity storms, which constitute the majority of annual rainfall volume.

Full report available at www.contechstormwater.com.

Laboratory Testing

Full reports available at www.contechstormwater.com

Technical Bulletin 1: Removal Efficiencies for Selected Particle Gradations

Technical Bulletin 2: Particle Distribution of Sediments and the Effect on Heavy Metal Removal

Technical Bulletin 3: Sizing for Net Annual Sediment Removal

Technical Bulletin 3a: Determining Bypass Weir Elevation for Off-Line Systems

Technical Bulletin 4: Modeling Long Term Load Reduction: The Rational Rainfall Method

Technical Bulletin 5: Oil Removal Efficiency

Field Monitoring

Following are brief summaries of the field tests completed to date.

Full reports available at www.contechstormwater.com

DeLorme Mapping Company

Yarmouth, ME

CONTECH Stormwater Solutions

Prior to this premier field test of the Vortechs system, CONTECH developed an extensive body of laboratory data to document total suspended solids (TSS) removal efficiency. CONTECH performed this field study in order to compare the performance predicted using laboratory data to the performance of a correctly sized system in the field.

The study site was the headquarters of DeLorme Mapping in Yarmouth, Maine. The building, driveway, parking lot and ancillary facilities were constructed in 1996. A Vortechs model 11000 was installed to treat runoff from the 300-space, 4-acre (1.62-ha) parking lot.

Testing Period	May 1999 to Dec 1999
# of Storms Sampled	20
Mean Influent Concentration	328-mg/L
Mean Effluent Concentration	60-mg/L
Removal Efficiency	82%

The main purpose of the DeLorme study was to verify that the sizing methodology developed from our full-scale laboratory testing was valid and an accurate means of predicting field performance. The results of the study confirmed our sizing methodology.

Village Marine Drainage

Lake George, NY

New York State Department of Environmental Conservation, Division of Water

The New York State DEC used funds obtained in a Section 319 grant to initiate a study of the effectiveness of the Vortechs system to remove sediment and other pollutants transported

by stormwater to Lake George, Lake George Village, New York. "Since the 1970s, when there was a rapid increase in the rate and concentration of development along the southwestern shores of Lake George, we have been concerned about the impact of stormwater discharges into the lake," said Tracy West, co-author of the study.

Testing Period	Feb 2000 to Dec 2000
# of Storms Sampled	13
Mean Influent Concentration	801-mg/L
Mean Effluent Concentration	105-mg/L
Removal Efficiency	88%

The study concluded that the Village and Town of Lake George should consider installing additional Vortechs systems in areas where sedimentation and erosion have been identified as non-point source pollution problems.

**Harding Township Rest Area
Harding Township, NJ
RTP Environmental Associates**

This third party evaluation was performed under a U.S. Environmental Protection Agency grant, administered by the New Jersey Department of Environmental Protection. A. Roger Greenway, principal of RTP Environmental Associates, Inc., conducted the study in conjunction with Thonet Associates, which assisted with data analysis and helped develop best management practices (BMP) recommendations.

The Vortechs model 4000 was sized to handle a 100-year storm from the 3 acre (1.21 ha) paved parking area at the Harding Rest Stop, located off the northbound lane of I-287 in Harding Township, New Jersey.

Testing Period	May 1999 to Nov 2000
# of Storms Sampled	5
Mean Influent Concentration (TSS)	493-mg/L
Mean Effluent Concentration (TSS)	35-mg/L
Removal Efficiency (TSS)	93%
Mean Influent Concentration (TPH)	16-mg/L
Mean Effluent Concentration (TPH)	5-mg/L
Removal Efficiency (TPH)	67%

The study concluded that truck rest stops and similar parking areas would benefit from installing stormwater treatment systems to mitigate the water quality impacts associated with stormwater runoff from these sites.

**Timothy Edwards Middle School
South Windsor, CT**

UCONN Department of Civil & Environmental Engineering

This study of the Vortechs system was published as a thesis by Susan Mary Board, as part of the requirements for a Master of Science degree from the University of Connecticut. Her objective was to determine how well the Vortechs system retained pollutants from parking lot runoff, including total suspended solids (TSS), nutrients, metals, and petroleum hydrocarbons.

A Vortechs model 5000 was installed in 1998 to treat runoff from the 82-space parking lot of Timothy Edwards Middle School. The entire watershed was approximately 2 acres (0.81 ha), and was 80% impervious.

Testing Period	Jul 2000 to Apr 2001
# of Storms Sampled	weekly composite samples taken
Mean Influent Concentration	324-mg/L
Mean Effluent Concentration	73-mg/L
Removal Efficiency	77%

Additionally, the Vortechs system was particularly effective in removing zinc (85%), lead (46%), copper (56%), phosphorus (67%) and nitrate (54%).

The study concluded that the Vortechs system significantly reduced effluent concentrations of many pollutants in stormwater runoff.



Maintenance

The Vortechs system should be inspected at regular intervals and maintained when necessary to ensure optimum performance. The rate at which the system collects pollutants will depend more heavily on site activities than the size of the unit, e.g., unstable soils or heavy winter sanding will cause the swirl chamber to fill more quickly but regular sweeping will slow accumulation.

Inspection

Inspection is the key to effective maintenance and is easily performed. Pollutant deposition and transport may vary from year to year and regular inspections will help ensure that the system is cleaned out at the appropriate time. Inspections should be performed twice per year (i.e. spring and fall) however more frequent inspections may be necessary in equipment washdown areas and in climates where winter sanding operations may lead to rapid accumulations. It is useful and often required as part of a permit to keep a record of each inspection. A simple inspection and maintenance log form for doing so is provided on the following page, and is also available on contechstormwater.com.

The Vortechs system should be cleaned when inspection reveals that the sediment depth has accumulated to within 12 to 18 inches (300 to 450 mm) of the dry-weather water surface elevation. This determination can be made by taking two measurements with a stadia rod or similar measuring device; one measurement from the manhole opening to the top of the sediment pile and the other from the manhole opening to the water surface. **Note:** To avoid underestimating the volume of sediment in the chamber, the measuring device must be carefully lowered to the top of the sediment pile. Finer, silty particles at the top of the pile typically offer less resistance to the end of the rod than larger particles toward the bottom of the pile.

Cleaning

Cleaning of the Vortechs system should be done during dry weather conditions when no flow is entering the system. Clean-out of the Vortechs system with a vacuum truck is generally the most effective and convenient method of excavating pollutants from the system. If such a truck is not available, a "clamshell" grab may be used, but it is difficult to remove all accumulated pollutants using a "clamshell".

In installations where the risk of petroleum spills is small, liquid contaminants may not accumulate as quickly as sediment. However, an oil or gasoline spill should be cleaned out immediately. Motor oil and other hydrocarbons that accumulate on a more routine basis should be removed when an appreciable layer has been captured. To remove these pollutants, it may be preferable to use adsorbent pads to solidify the oil since these pads are usually much easier to remove from the unit individually and less expensive to dispose of than the oil/water emulsion that may be created by vacuuming the oily layer. Floating trash can be netted out if you wish to separate it from the other pollutants.

Cleaning of a Vortechs system is typically done by inserting a vacuum hose into the swirl chamber and evacuating this chamber of water and pollutants. As water is evacuated, the water level outside of the swirl chamber will drop to a level roughly equal to the crest of the lower aperture of the swirl chamber. The water outside the swirl chamber should remain

near this level throughout pumping as the bottom and sides of the swirl chamber are sealed to the tank floor and walls. This "water lock" feature prevents water from migrating into the swirl chamber, exposing the bottom of the baffle wall and creating excess pump-out volume. Floating pollutants will decant into the swirl chamber as the water level is drawn down. This allows most floating material to be withdrawn from the same access point above the swirl chamber. Floating material that does not decant into the swirl chamber during draw down should be skimmed from the baffle chamber. If maintenance is not performed as recommended, sediment may accumulate outside the swirl chamber. If this is the case, it may be necessary to pump out other chambers. It is advisable to check for sediment accumulation in all chambers during inspection and maintenance.

These maintenance recommendations apply to all Vortechs systems with the following exceptions:

1. It is strongly recommended that when cleaning systems larger than the Model 16000 the baffle chamber be drawn down to depth of three feet prior to beginning clean-out of the swirl chamber. Drawing down this chamber prior to the swirl chamber reduces adverse structural forces pushing upstream on the swirl chamber once that chamber is empty.
2. Entry into a Vortechs system is generally not required as cleaning can be done from the ground surface. However, if manned entry into a system is required the entire system should be evacuated of water prior to entry regardless of the system size.

Manhole covers should be securely seated following cleaning activities to prevent leakage of runoff into the system from above and also to ensure proper safety precautions. If anyone physically enters the unit, Confined Space Entry procedures need to be followed.

Disposal of all material removed from the Vortechs system should be done in accordance with local regulations. In many locations, disposal of evacuated sediments may be handled in the same manner as disposal of sediments removed from catch basins or deep sump manholes. Check your local regulations for specific requirements on disposal.

For assistance with maintaining your Vortechs system, contact us regarding the CONTECH Maintenance Compliance Certification Program.

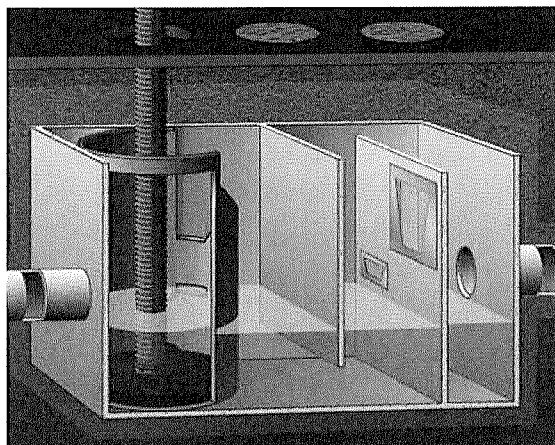

Vortechs Inspection & Maintenance Log

Vortech Model: _____ Location: _____

Date	Water depth to sediment ¹	Floatable Layer Thickness ²	Describe Maintenance Performed	Maintenance Personnel	Comments

1. The water depth to sediment is determined by taking two measurements with a stadia rod: one measurement from the manhole opening to the top of the sediment pile and the other from the manhole opening to the water surface. If the difference between these measurements is less than eighteen inches the system should be cleaned out. Note: To avoid underestimating the volume of sediment in the chamber, the measuring device must be carefully lowered to the top of the sediment pile.
2. For optimum performance, the system should be cleaned out when the floating hydrocarbon layer accumulates to an appreciable thickness. In the event of an oil spill, the system should be cleaned immediately.

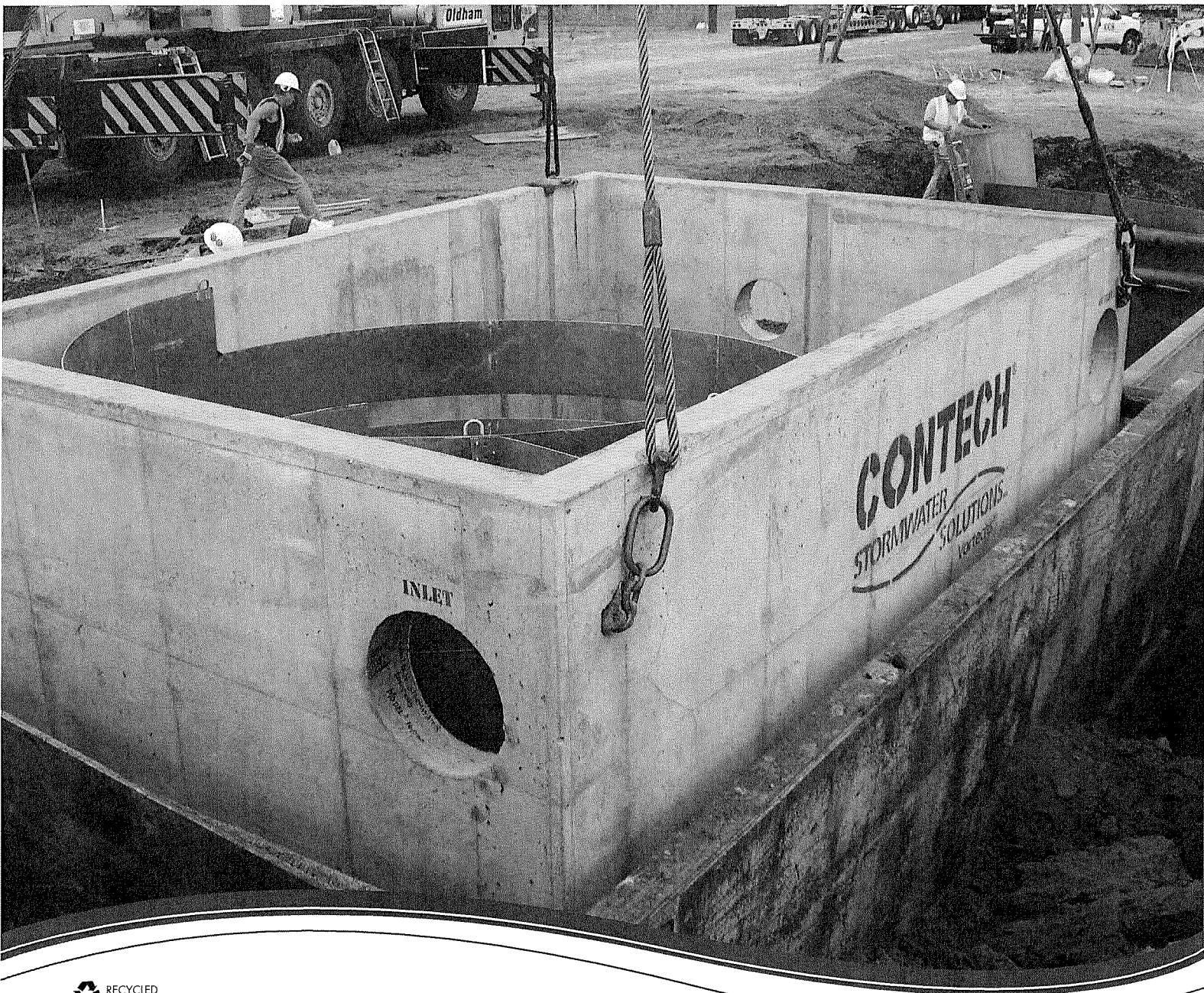

800.925.5240
contechstormwater.com

Support

- Drawings and specifications are available at www.contechstormwater.com.
- Site-specific design support is available from our engineers.

©2008 CONTECH Stormwater Solutions

CONTECH Construction Products Inc. provides site solutions for the civil engineering industry. CONTECH's portfolio includes bridges, drainage, sanitary sewer, stormwater and earth stabilization products. For information on other CONTECH division offerings, visit contech-cpi.com or call 800.338.1122

Nothing in this catalog should be construed as an expressed warranty or an implied warranty of merchantability or fitness for any particular purpose. See the CONTECH standard quotation or acknowledgement for applicable warranties and other terms and conditions of sale.

The product(s) described may be protected by one or more of the following US patents: 5,322,629; 5,624,576; 5,707,527; 5,759,415; 5,788,848; 5,985,157; 6,027,639; 6,350,374; 6,406,218; 6,641,720; 6,511,595; 6,649,048; 6,991,114; 6,998,038; 7,186,058; 7,296,692; 7,297,266; related foreign patents or other patents pending.