

BE ADVISED THAT THESE ARE PRELIMINARY LAYOUTS INTENDED TO ILLUSTRATE DESIGN INTENT AND DIMENSIONS ARE FOR REFERENCE ONLY PRIOR TO FINAL ENGINEERING

ROCHESTER HILLS F.D.

2737 FORSYTH RD, WINTER PARK, FL 32792
PHONE: 407-677-7777

COMPARTMENT SIZES INSIDE DIMENSIONS				JAMB OPENING		MARQUE AMBULANCE					
NO.	HEIGHT	WIDTH	DEPTH	HEIGHT	WIDTH						
						170 COMMANDO FREIGHTLINER M2					
BODY: 170" L X 98"W X 72"H PASS THRU											
FRONT/REAR ELEVATION			03/24/20	DLM	MM185844						

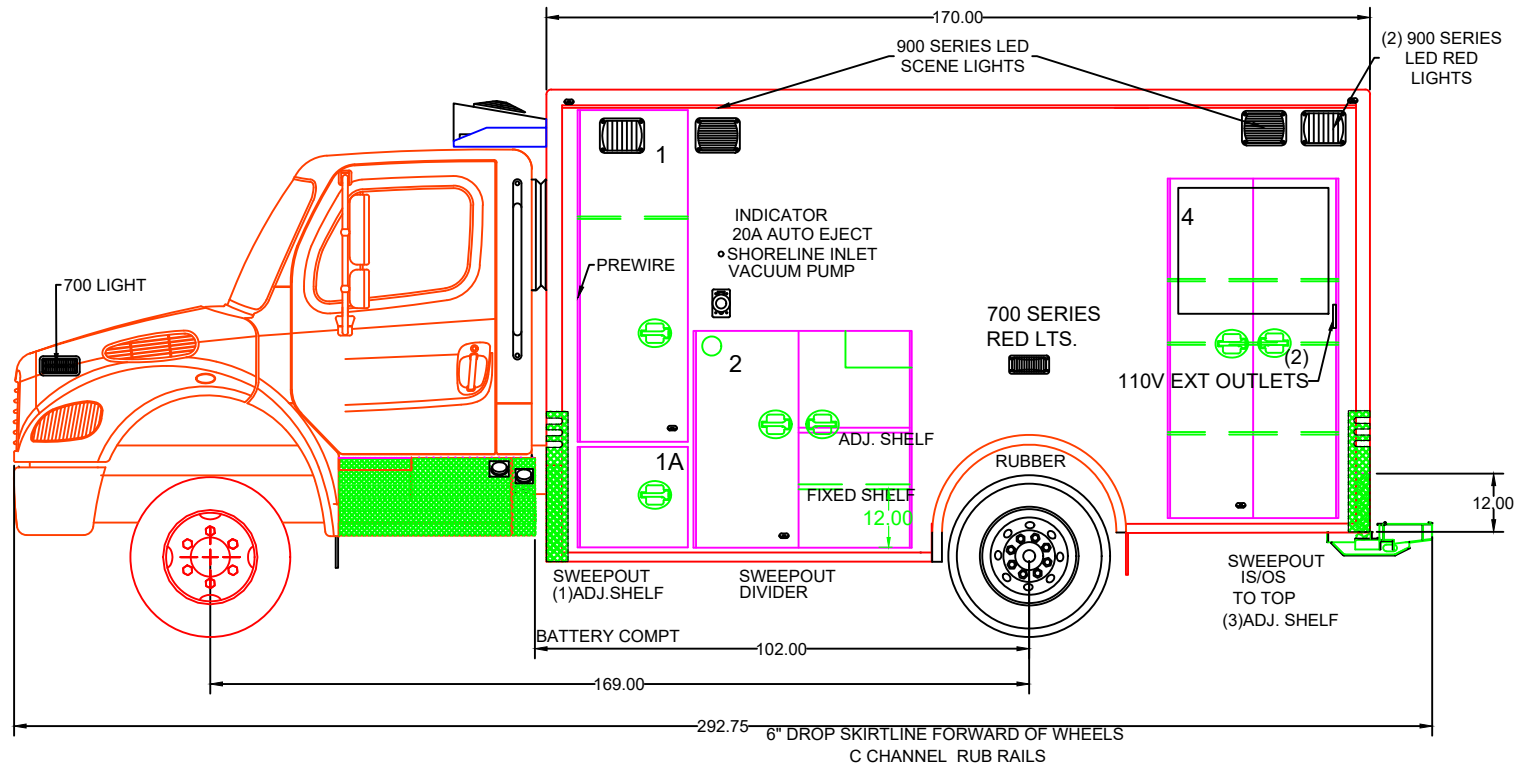

DIMENSIONS ARE ROUNDED DOWN TO THE CLOSEST 1/4 INCH.

BE ADVISED THAT THESE ARE PRELIMINARY LAYOUTS INTENDED TO ILLUSTRATE DESIGN INTENT AND DIMENSIONS ARE FOR REFERENCE ONLY PRIOR TO FINAL ENGINEERING

ROCHESTER HILLS F.D.

2737 FORSYTH RD, WINTER PARK, FL 32792
PHONE: 407-677-7777

COMPARTMENT SIZES INSIDE DIMENSIONS				JAMB OPENING		MARQUE AMBULANCE			
NO.	HEIGHT	WIDTH	DEPTH	HEIGHT	WIDTH				
1	68.50	23.50	20.00	67.75	21.25	170 COMMANDO FREIGHTLINER M2			
1A	20.75	48.00	20.00	20.25	46.00	BODY: 170" L X 98"W X 72"H PASS THRU			
2	46.50	48.00	20.00	46.00	46.00	FRONT/REAR ELEVATION 03/24/20 DLM MM185844			
4	71.25	35.35	20.00	70.75	32.50				

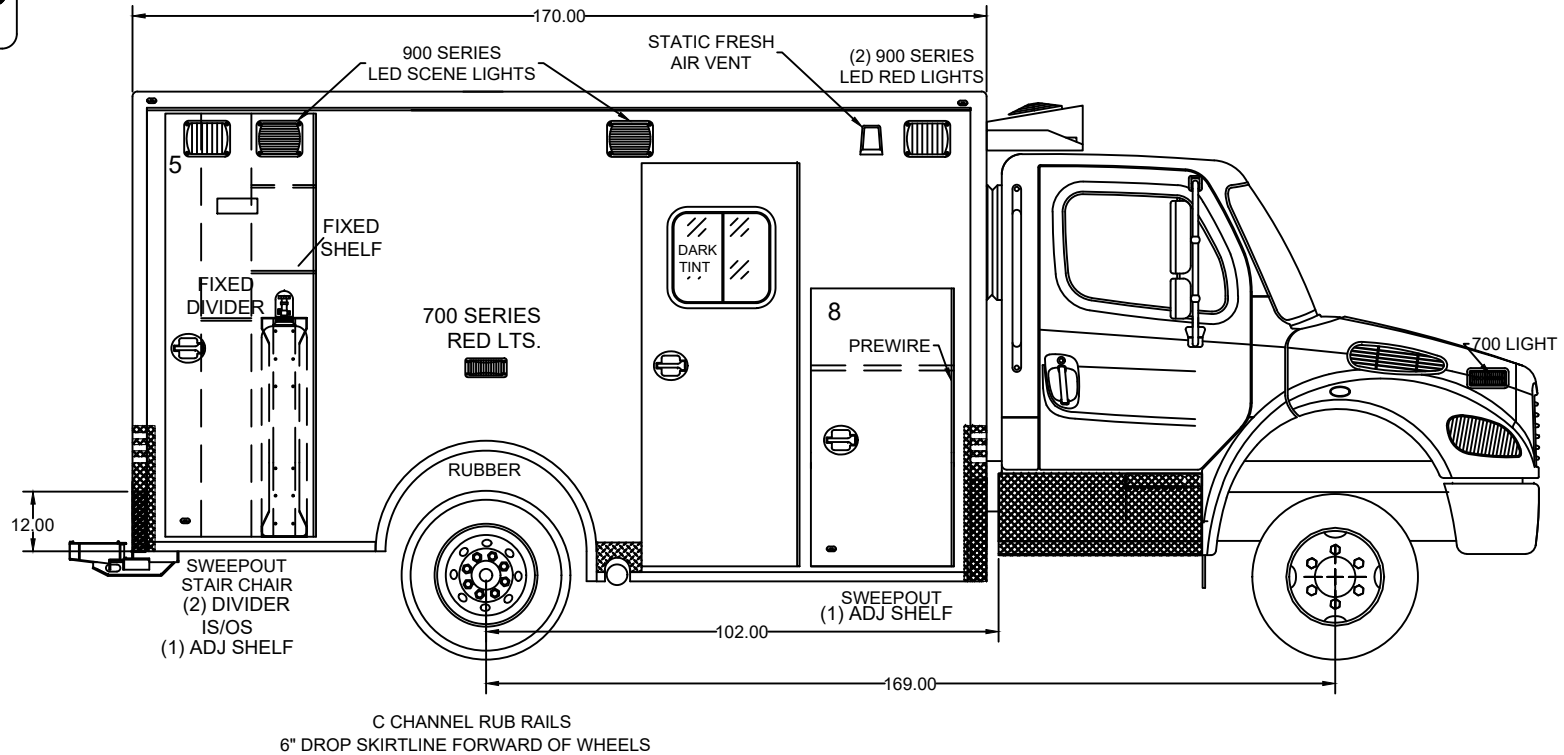

DIMENSIONS ARE ROUNDED DOWN TO THE CLOSEST 1/4 INCH
 BE ADVISED THAT THESE ARE PRELIMINARY LAYOUTS INTENDED
 TO ILLUSTRATE DESIGN INTENT AND DIMENSIONS ARE FOR
 REFERENCE ONLY PRIOR TO FINAL ENGINEERING

ROCHESTER HILLS F.D.

2737 FORSYTH RD, WINTER PARK, FL 32792
 PHONE: 407-677-7777

COMPARTMENT SIZES INSIDE DIMENSIONS				JAMB OPENING		MARQUE AMBULANCE
NO.	HEIGHT	WIDTH	DEPTH	HEIGHT	WIDTH	
5	85.75	30.00	21.75	84.25	28.50	170 COMMANDO FREIGHTLINER M2
6	--	--	--	--	--	BODY: 170" L X 98"W X 72"H PASS THRU
8	55.25	30.25	19.00	55.75	27.00	FRONT/REAR ELEVATION
						03/24/20
						DLM
						MM185844



BE ADVISED THAT THESE ARE PRELIMINARY LAYOUTS INTENDED TO ILLUSTRATE DESIGN INTENT AND DIMENSIONS ARE FOR REFERENCE ONLY PRIOR TO FINAL ENGINEERING DIMENSIONS ARE ROUNDED DOWN TO THE CLOSEST 1/4 INCH

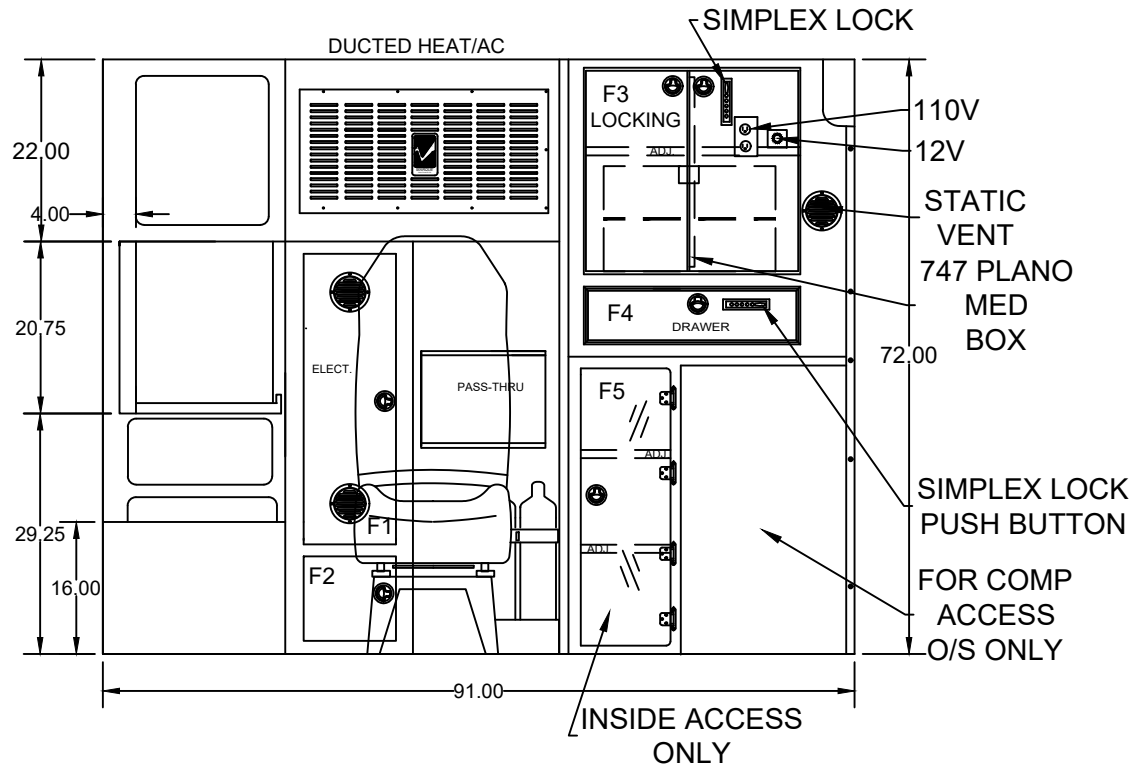

CABINET SIZES INSIDE DIMENSIONS

NO.	HEIGHT	WIDTH	DEPTH
F2	12.75	12.00	21.25
F3	24.00	25.25	32.00
F4	7.00	23.25	29.00
F5	34.25	12.00	31.00

ROCHESTER HILLS F.D.

2737 FORSYTH RD, WINTER PARK, FL 32792
PHONE: 407-677-7777

MARQUE AMBULANCE

170 COMMANDO FREIGHTLINER M2

BODY: 170" L X 98"W X 72"H PASS THRU

FRONT/REAR ELEVATION	03/24/20	DLM	MM185844
----------------------	----------	-----	----------

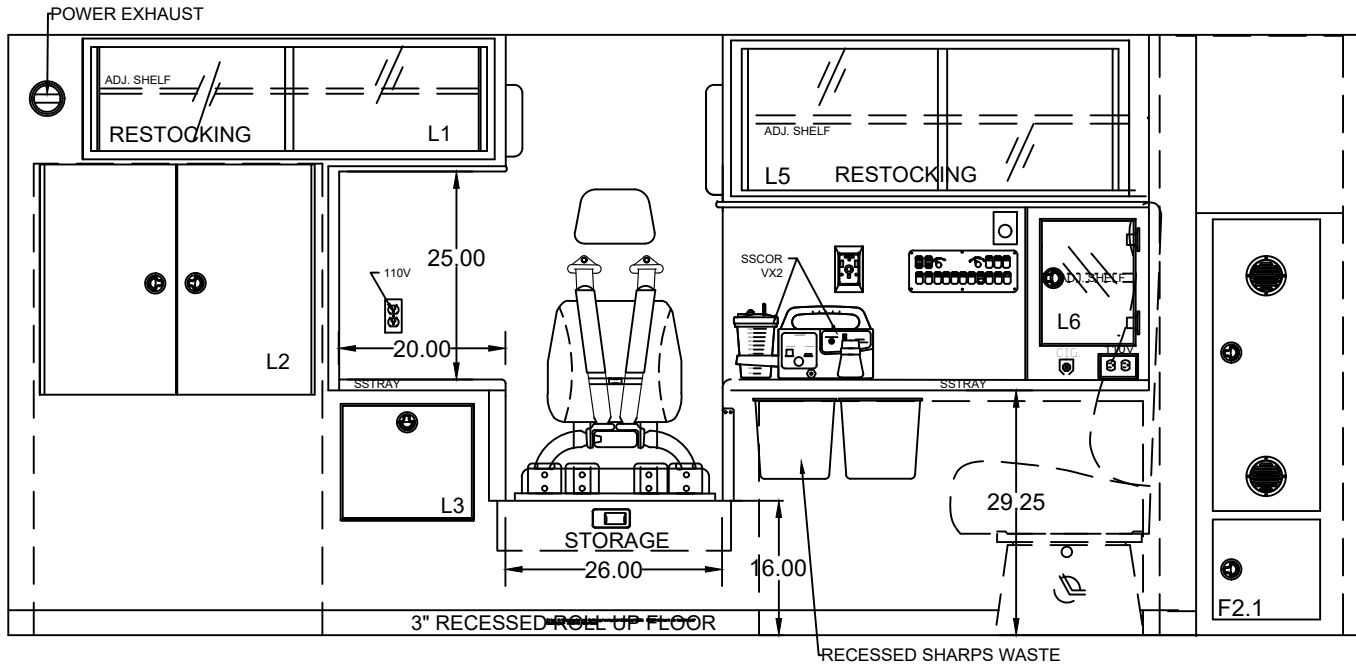

BE ADVISED THAT THESE ARE PRELIMINARY LAYOUTS INTENDED TO ILLUSTRATE DESIGN INTENT AND DIMENSIONS ARE FOR REFERENCE ONLY PRIOR TO FINAL ENGINEERING

CABINET SIZES INSIDE DIMENSIONS

NO.	HEIGHT	WIDTH	DEPTH
L1	12.50	45.50	21.75
L2	21.00	31.00	IS/OS
L3	18.50	18.25	17.75
L5	19.75	49.50	18.50
L6	14.50	12.00	7.50

DIMENSIONS ARE ROUNDED DOWN TO THE CLOSEST 1/4 INCH

2737 FORSYTH RD, WINTER PARK, FL 32792
PHONE: 407-677-7777

ROCHESTER HILLS F.D.

MARQUE AMBULANCE

170 COMMANDO FREIGHTLINER M2

BODY: 170" L X 98"W X 72"H PASS THRU

FRONT/REAR ELEVATION	03/24/20	DLM	MM185844
----------------------	----------	-----	----------

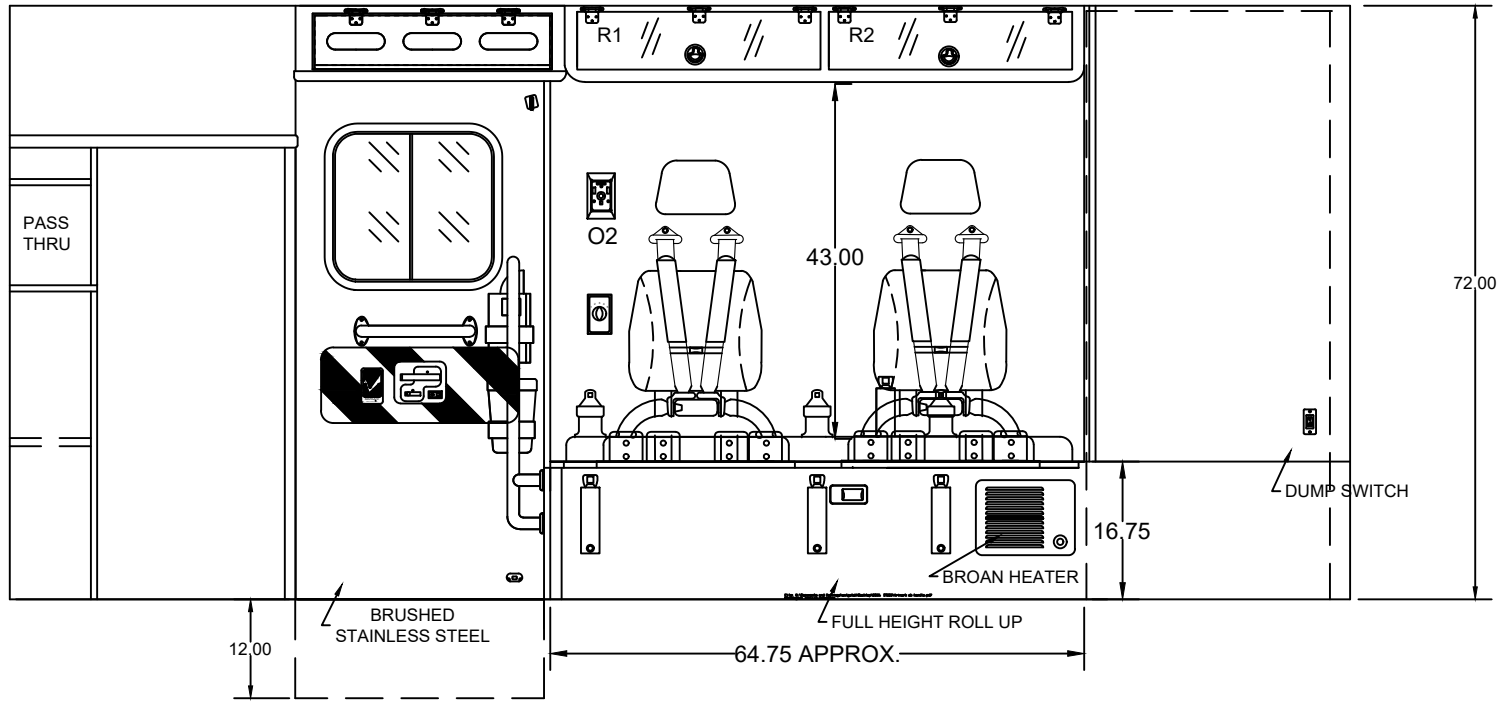

BE ADVISED THAT THESE ARE PRELIMINARY LAYOUTS INTENDED TO ILLUSTRATE DESIGN INTENT AND DIMENSIONS ARE FOR REFERENCE ONLY PRIOR TO FINAL ENGINEERING

CABINET SIZES INSIDE DIMENSIONS			
NO.	HEIGHT	WIDTH	DEPTH
R1/R2	6.75	27.50	8.00

REV. 9/20/13

DIMENSIONS ARE ROUNDED DOWN TO THE CLOSEST 1/4 INCH

ROCHESTER HILLS F.D.

2737 FORSYTH RD, WINTER PARK, FL 32792
PHONE: 407-677-7777

MARQUE AMBULANCE

170 COMMANDO FREIGHTLINER M2

BODY: 170" L X 98"W X 72"H PASS THRU

FRONT/REAR ELEVATION	03/24/20	DLM	MM185844
----------------------	----------	-----	----------



BE ADVISED THAT THESE ARE PRELIMINARY LAYOUTS INTENDED TO ILLUSTRATE DESIGN INTENT AND DIMENSIONS ARE FOR REFERENCE ONLY PRIOR TO FINAL ENGINEERING

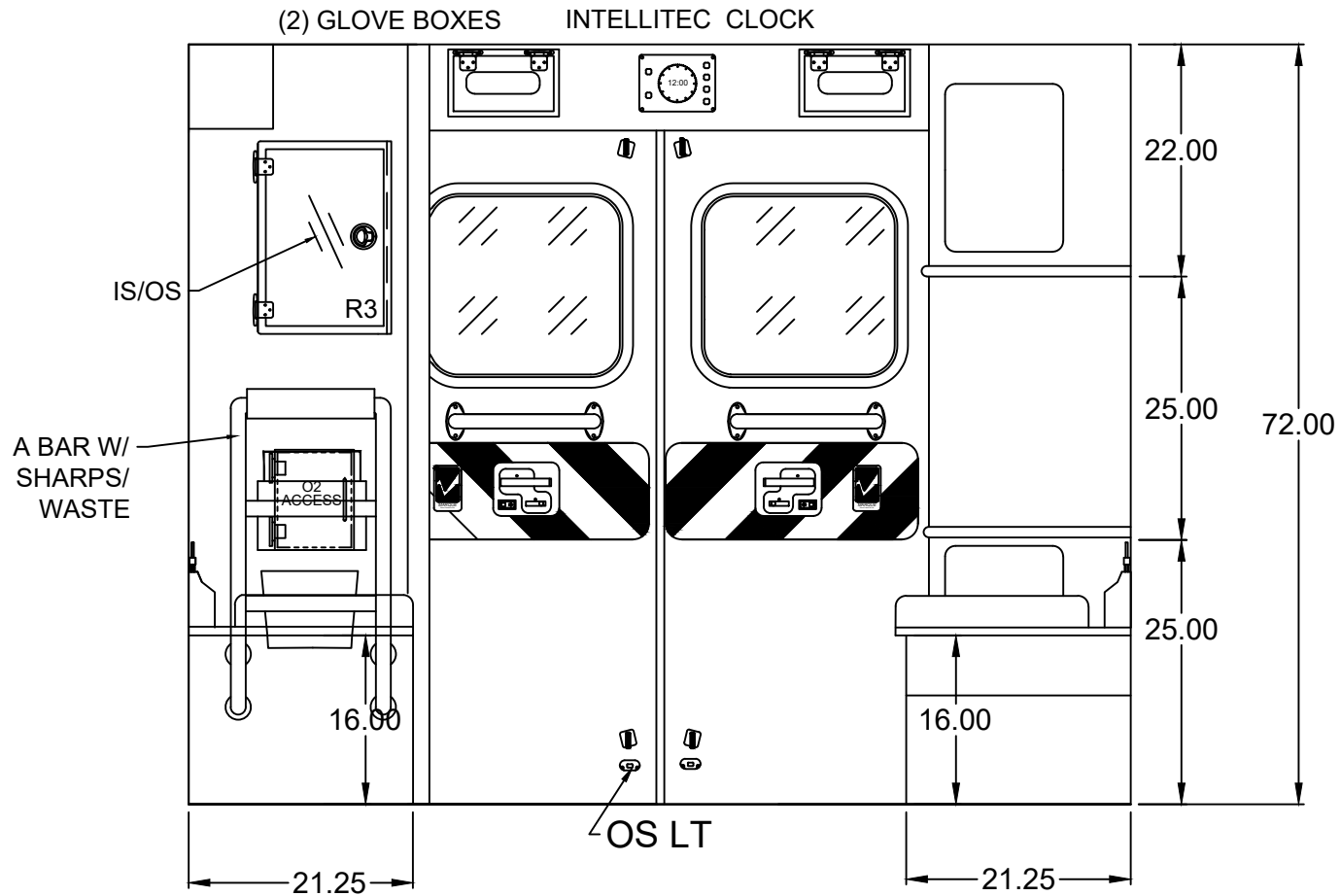

CABINET SIZES INSIDE DIMENSIONS

NO.	HEIGHT	WIDTH	DEPTH
R3	14.00	13.00	IS/OS

ROCHESTER HILLS F.D.

2737 FORSYTH RD, WINTER PARK, FL 32792
PHONE: 407-677-7777

MARQUE AMBULANCE

170 COMMANDO FREIGHTLINER M2

BODY: 170" L X 98"W X 72"H PASS THRU

FRONT/REAR ELEVATION	03/24/20	DLM	MM185844
----------------------	----------	-----	----------



BE ADVISED THAT THESE ARE PRELIMINARY LAYOUTS INTENDED TO ILLUSTRATE DESIGN INTENT AND DIMENSIONS ARE FOR REFERENCE ONLY PRIOR TO FINAL ENGINEERING

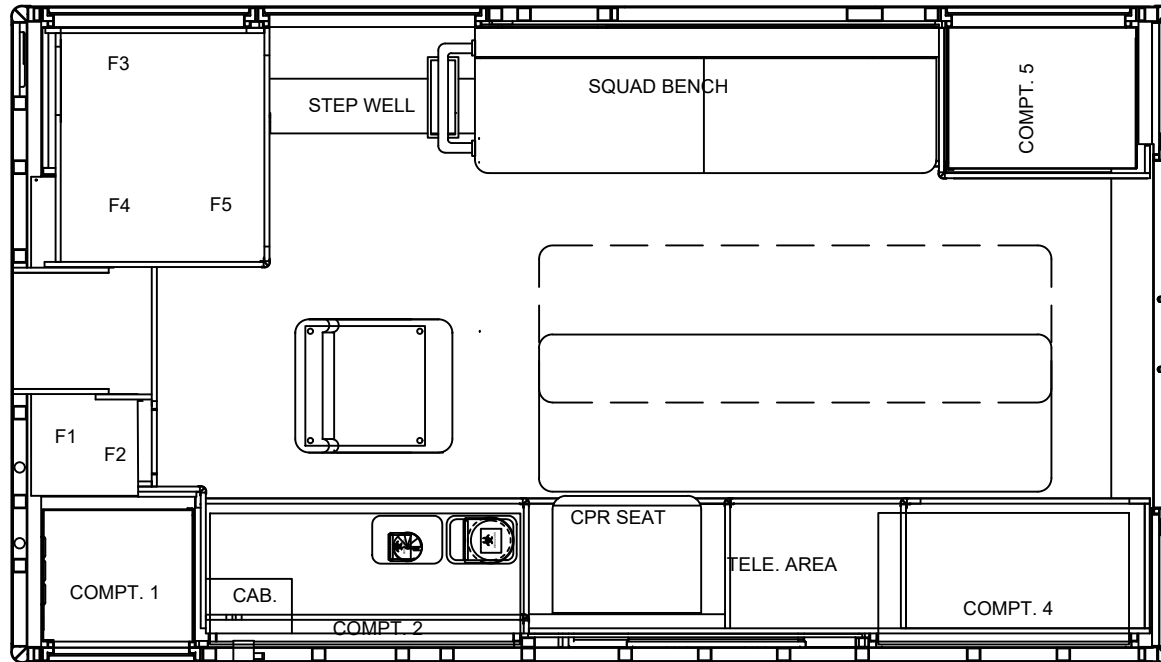

CABINET SIZES INSIDE DIMENSIONS			
NO.	HEIGHT	WIDTH	DEPTH
R3	14.00	13.00	IS/OS

ROCHESTER HILLS 9Q6019-23

2737 FORSYTH RD, WINTER PARK, FL 32792
PHONE: 407-677-7777

MARQUE AMBULANCE			
170 COMMANDO FREIGHTLINER M2			
BODY: 170" L X 98"W X 72"H PASS THRU			
REAR INT. ELEVATION	9/29/16	CJ	MM160688

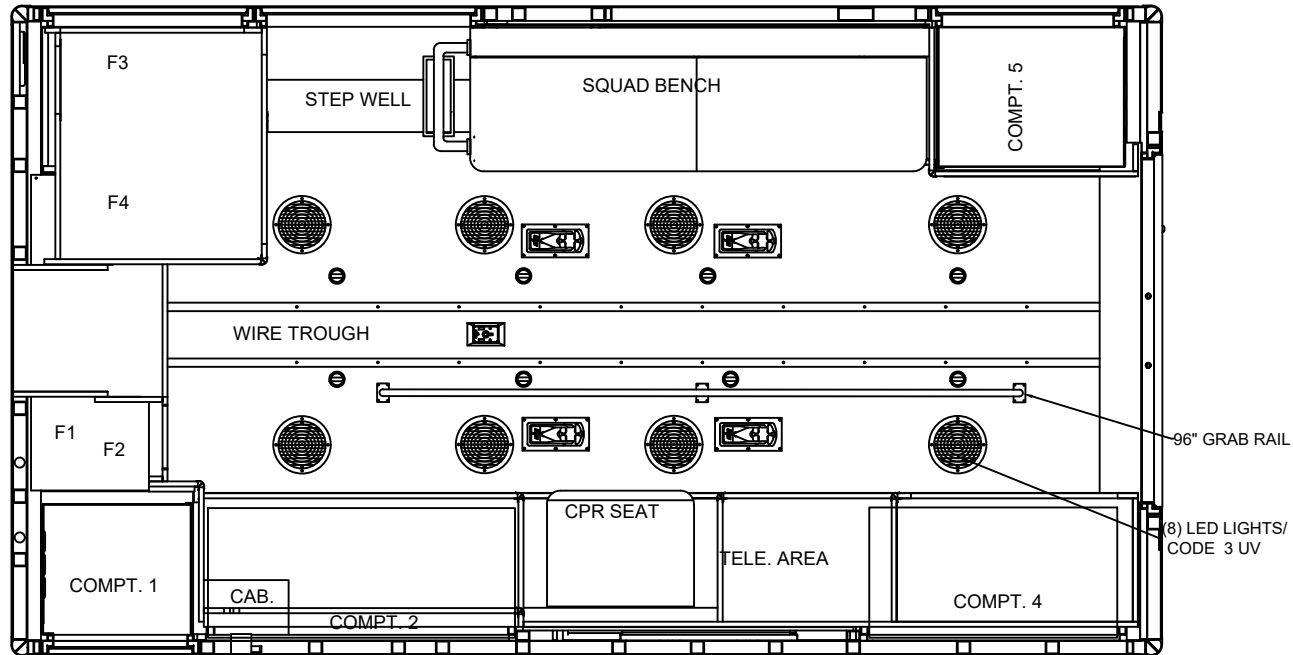

BE ADVISED THAT THESE ARE PRELIMINARY LAYOUTS INTENDED TO ILLUSTRATE DESIGN INTENT AND DIMENSIONS ARE FOR REFERENCE ONLY PRIOR TO FINAL ENGINEERING

CABINET SIZES INSIDE DIMENSIONS

NO.	HEIGHT	WIDTH	DEPTH

ROCHESTER HILLS 9Q6019-23

2737 FORSYTH RD, WINTER PARK, FL 32792
PHONE: 407-677-7777

MARQUE AMBULANCE

170 COMMANDO FREIGHTLINER M2

BODY: 170" L X 98"W X 72"H PASS THRU

LINER LAYOUT PLAN

9/29/16

CJ

MM160690