

# Limited Phase II Environmental Site Assessment

Hamlin Road Sewer Extension  
South Side of Hamlin Road, East of Adams Road,  
Rochester Hills, Oakland County, Michigan

City of Rochester Hills

July 11, 2024

ASTI ENVIRONMENTAL



# Limited Phase II Environmental Site Assessment

## Hamlin Road Sewer Extension South Side of Hamlin Road, East of Adams Road, Rochester Hills, Oakland County, Michigan

July 11, 2024

**Prepared For:**

City of Rochester Hills  
1000 Rochester Hills Drive  
Rochester Hills, MI 48309

**Report Prepared By:**

ASTI Environmental  
10448 Citation Drive, Suite 100  
Brighton, Michigan 48116  
(810) 225-2800

**ASTI Project No. A24-3059.01**

Report Prepared by:



Jack Green  
Environmental Technician

Report Reviewed by:

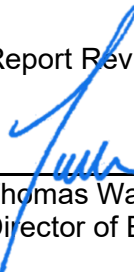

Thomas Wackerman  
Director of Environmental Services



## TABLE OF CONTENTS

<u>Section</u>	<u>Page</u>
Title Page	i
Table of Contents	ii
1.0 Introduction	1
2.0 Purpose and Current Use of the Investigation Area	1
2.1 Purpose	1
2.2 Current Uses of the Investigation Area	2
3.0 Deviations from Work Plan	2
4.0 Sampling Locations	2
5.0 Sample Collection Procedures	3
6.0 Pathway Evaluation	7
7.0 Soil and Groundwater Characteristics	8
7.1 Soil	8
7.2 Groundwater	8
8.0 Analytical Results	8
9.0 Conclusions And Recommendations	10

### FIGURES

- 1 Site Location Map
- 2 Sample Location Map

### TABLE

- 1 Summary of Soil Sample Analytical Results
- 2 Summary of Groundwater PFAS Sample Analytical Results
- 3 Summary of Groundwater Sample Analytical Results
- 4 Summary of Soil Gas Screening Results

### ATTACHMENTS

- A Proposed Sewer Extension Plans
- B Soil Gas Sampling Forms
- C Groundwater Sampling Field Data Sheet
- D Soil Boring Logs
- E Laboratory Analytical Reports and Chain-of-Custody Documentation

## **1.0 INTRODUCTION**

ASTI Environmental (ASTI) was retained by City of Rochester Hills to conduct a Limited Phase II Environmental Site Assessment (ESA) for the area located on the south side of Hamlin Road and east of Adams Road in the City of Rochester Hills, Oakland County, Michigan (Investigation Area). The Investigation Area comprises portions of 2801 West Hamlin Road (Parcel ID 15-29-151-012), 2463 West Hamlin Road (Parcel ID 15-29-151-011), and the Hamlin Road Right-of-Way (ROW). This investigation was prepared for the benefit of City of Rochester Hills, and ASTI acknowledges that said party may rely upon the contents and conclusions presented in this report. A Site Location Map is provided as Figure 1.

The Limited Phase II ESA for the Investigation Area was conducted on May 22 and 23, 2024, in accordance with the Michigan Department of Environment, Great Lakes, and Energy (EGLE) approved Brownfield Grant Work Plan dated April 15, 2024. This investigation was funded by an EGLE Grant titled Rochester Hills Restoration and Remediation Grant (Tracking Code 2023-2540, Location Code 6K60)

## **2.0 PURPOSE AND CURRENT USE OF THE INVESTIGATION AREA**

### **2.1 Purpose**

City of Rochester intends to install a new sanitary sewer in the Investigation Area. The sanitary sewer will be installed along the south side of Hamlin Road east of Adams Road. It will start at 2800 West Hamlin Road, cross Hamlin Road to the south, proceed east along the south side of Hamlin Road adjacent to the former Cardinal and Veterans Landfills, cross a portion of 2456 Hamlin Road, and terminate at an existing connection located at 2450 Norfolk. The Proposed Sewer Extension Plans are included as Attachment A. There are three proposed manholes (MH-3 through MH-5) in the Investigation Area, and one proposed manhole (MH-2) outside the Investigation Area.

The sanitary sewer will be installed using directional drilling, but soils will be removed for the construction of four manholes. In addition, dewatering may be required, specifically at the eastern end of the Investigation Area, where the bottom of the two easternmost manholes may be below groundwater levels observed in previous investigations.

No impacts were historically identified in the Investigation Area. However, because of the proximity to the former Cardinal and Veterans Landfills, there is the potential for groundwater and/or soil gas migration of contaminants onto the Investigation Area, especially during dewatering.

The purpose of the Limited Phase II ESA was to investigate potential soil, soil gas, and groundwater impacts from adjacent historical uses in the area of the proposed sanitary sewer extension manholes.

## **2.2 Current Uses of the Investigation Area**

Addresses 2801 West Hamlin Road and 2463 West Hamlin Road in the Investigation Area are currently vacant land.

## **3.0 DEVIATIONS FROM WORK PLAN**

ASTI did not deviate from the scope of work outlined in the Brownfield Grant Work Plan.

## **4.0 SAMPLING LOCATIONS**

On May 22, 2024, ASTI completed three soil borings (SB-1 through SB-3) at the Investigation Area. ASTI also completed one soil boring (SB-4) outside the Investigation Area because of the potential for groundwater migration. The soil borings were advanced to approximately 12 to 16 feet below ground surface (bgs) using a direct-push Geoprobe® drill rig. Groundwater was encountered in each soil boring, and permanent monitoring wells were installed at borings SB-3 and SB-4. Additionally, ASTI installed four soil gas wells (SG-1 through SG-4) adjacent to each soil boring location. A Sample Location Map is provided as Figure 2. Boring/sample identifications, boring/sample locations, and depths were as follows:

<b>Boring/Sample ID</b>	<b>Boring/Sample Location</b>	<b>Depth of Boring (bgs)</b>
SB-1	At the location of MH-5 to assess potential contaminant migration from the adjacent landfills	12 feet

Boring/Sample ID	Boring/Sample Location	Depth of Boring (bgs)
SB-2	At the location of MH-4 to assess potential contaminant migration from the adjacent landfills	16 feet
SB-3-MW	At the location of MH-3 to assess potential contaminant migration from the adjacent landfills	16 feet
SB-4-MW	At the location of MH-2 to assess potential contaminant migration from the adjacent landfills	12 feet
SG-1	Directly adjacent to soil boring SB-1 to assess methane in soil gas	5.5 feet
SG-2	Directly adjacent to soil boring SB-2 to assess methane in soil gas	5.5 feet
SG-3	Directly adjacent to soil boring SB-3 to assess methane in soil gas	5.5 feet
SG-4	Directly adjacent to soil boring SB-4 to assess methane in soil gas	5.5 feet

## 5.0 SAMPLE COLLECTION PROCEDURES

With the drill rig, soil was extracted from the ground in pre-cleaned, 4-foot-long, acetate liners. Soil encountered during field activities was classified by ASTI's field personnel, examined for visual and/or olfactory evidence of impact, and screened using a photoionization detector (PID), with notes recorded in a field logbook. Prior to sampling, the PID was calibrated to manufacturer specifications using 100 parts per million (ppm) isobutylene calibration gas. All down-hole equipment was decontaminated using an Alconox® wash and clean water rinse prior to and between borings to minimize the risk of cross contamination of the samples.

Prior to collecting samples, ASTI field staff donned a PFAS-free cover-all suit and a new pair of PFAS-free nitrile gloves.

### Soil Sampling

ASTI collected two soil samples from each soil boring. At each boring location, soil samples were collected from approximately 10 feet below ground surface (bgs) and from the bottom of the boring or above groundwater first encountered. The soil samples were collected into laboratory-certified clean unpreserved 4-ounce glass jars, 40-milliliter (mL) glass vials preserved with methanol, 125-mL unpreserved high-density polyethylene (HDPE) bottles, and unpreserved 15-mL polypropylene (PP) centrifuge tubes that were subsequently placed

on ice and submitted to Merit Laboratories Inc. (Merit) in East Lansing, Michigan under standard chain-of-custody procedures.

The soil samples were analyzed for polynuclear aromatic hydrocarbons (PNAs) by US Environmental Protection Agency (EPA) Method 8270D, volatile organic compounds (VOCs) by US EPA Method 5035A/8260C, the Michigan 10 metals (arsenic, barium, cadmium, chromium, copper, lead, mercury, selenium, silver, and zinc) by US EPA Methods 6020A and 7471B, polychlorinated biphenyls (PCBs) by US EPA Method 8082A, and per- and polyfluoroalkyl substances (PFAS) by US EPA Method 7968-17M.

For Quality Assurance/Quality Control (QA/QC) purposes, one duplicate soil sample, DUP-1S, was collected from SB-4 (10-11'). Additionally, a methanol blank was maintained with the samples during sampling and transport.

#### Soil Gas Screening

The soil gas wells were installed on May 22, 2024 using a 1.875-inch-long polyethylene vapor implant attached onto 1/4-inch outer-diameter, Teflon-lined tubing. The vapor implants were set at 5 feet bgs with the 1/4-inch tubing running up to the surface. Six inches of sand was backfilled below the implants to six inches above the implants, and the remainder of the borehole was sealed with hydrated granular bentonite to near surface. The wells were allowed a minimum of one hour to equilibrate before leak checking or soil gas screening was conducted.

Prior to screening, each sampling train was checked for leaks using a chamber filled with argon gas. Three volumes of air were purged from the soil gas wells with a pump affixed to the chamber. After the initial purge, argon gas was injected into the chamber, and the purge was continued while the well and sampling train were checked for leaks using an argon detector. The soil gas wells were subsequently screened for oxygen, carbon dioxide, methane, and carbon monoxide using a landfill gas analyzer (LGA). Refer to the soil gas sampling forms provided as Attachment B.

## Groundwater Sampling

On May 23, 2024, ASTI sampled monitoring wells SB-3-MW and SB-4-MW. Each well was sampled using low-flow sampling protocols utilizing a peristaltic pump and dedicated polyethylene and silicone tubing. To assure formation water was being pumped, the inlet of the tubing was set within the approximate lower two feet of the screen interval, and the pumping rate was adjusted so that the static water level readings eventually stabilized with less than 0.3 feet of total draw-down.

While purging, the following water quality parameters were monitored for stabilization:

- Temperature;
- Specific conductivity;
- pH;
- RED/OX potential; and
- Turbidity.

Readings of these parameters were collected at 5-minute intervals utilizing a flow-through cell. At the point when these parameters were observed to be stable across three five-minute readings, samples were collected. Samples were collected by disconnecting the flow-through cell and directing the pump discharge directly into laboratory provided sample containers. Flow rate, static water level readings, and stabilization parameter readings collected during the purging were recorded on field data sheets provided in Attachment C.

Purged groundwater from the monitoring wells was containerized in a 55-gallon drum for offsite disposal. ERG Environmental Services (ERG) of Livonia, Michigan will complete the waste profile and dispose of the drum offsite at an approved facility.

ASTI collected a single groundwater sample from each monitoring well. The samples were collected into five 40-mL glass vials preserved in the field with hydrochloric acid, one 250-mL plastic bottle preserved with nitric acid, two unpreserved 1-liter amber glass jars, and three unpreserved 15-mL PP centrifuge tubes that were subsequently placed on ice. Note that the centrifuge tubes for PFAS analysis were placed in dedicated plastic zipper bags prior to being placed on ice. The groundwater samples were submitted to Merit under standard chain-of-custody procedures.



The groundwater samples were analyzed for VOCs by US EPA Method 5030C/8260C, PNAs by US EPA Method 8270D, the Michigan 10 Metals by US EPA Methods E200.8 and E245.1, PCBs by US EPA Method E608.3, PFAS by US EPA Method ASTM7979-19M, and dissolved methane by US EPA Method RSK-175.

For QA/QC purposes, one groundwater duplicate sample, DUP-1GW, was collected from SB-3-MW.

Sample depths, sample location rationale, and analyses are provided in the following table.

Boring	Sample Matrix	Sample Depth (feet bgs)	Rationale for sample depth	Analysis
SB-1	Soil	4-5'	Soil sample above groundwater	VOCs, PNAs, Michigan 10 Metals, PCBs, PFAS
		10-11'	Screen for disposed materials or lateral migration	VOCs, PNAs, Michigan 10 Metals, PCBs, PFAS
SB-2	Soil	9-10'	Soil sample above groundwater	VOCs, PNAs, Michigan 10 Metals, PCBs, PFAS
		10-11'	Screen for disposed materials or lateral migration	VOCs, PNAs, Michigan 10 Metals, PCBs, PFAS
SB-3	Soil	9-10'	Soil sample above groundwater	VOCs, PNAs, Michigan 10 Metals, PCBs, PFAS
		10-11'	Screen for disposed materials or lateral migration	VOCs, PNAs, Michigan 10 Metals, PCBs, PFAS
	Groundwater	Screen 6-16'	To assess for impacts in groundwater	VOCs, PNAs, Michigan 10 Metals, PCBs, PFAS, Dissolved Methane
SB-4	Soil	1.5-2.5'	Shallow sample above groundwater	VOCs, PNAs, Michigan 10 Metals, PCBs, PFAS
		10-11'	Screen for disposed materials or lateral migration	VOCs, PNAs, Michigan 10 Metals, PCBs, PFAS
	Groundwater	Screen 2-12'	To assess for impacts in groundwater	VOCs, PNAs, Michigan 10 Metals, PCBs, PFAS, Dissolved Methane
SG-1	Soil Gas	5'	Proximity to former landfill	Methane
SG-2	Soil Gas	5'	Proximity to former landfill	Methane
SG-3	Soil Gas	5'	Proximity to former landfill	Methane
SG-4	Soil Gas	5'	Proximity to former landfill	Methane

#### Waste Characterization Sampling

From each soil boring, an equal volume of soil was collected into a clean, gallon-size plastic bag. Following completion of the soil borings, the soil in the plastic bag was evenly mixed, and

a single, representative composite sample (SC-1) was prepared for waste characterization and landfill approval. The composite sample was collected into four laboratory-certified clean, unpreserved, 4-ounce glass jars that were subsequently placed on ice and submitted to Merit under standard chain-of-custody procedures.

The composite soil sample, SC-1, was analyzed for Toxic Characteristic Leaching Procedure (TCLP) RCRA 8 Metals (arsenic, barium, cadmium, chromium, lead, mercury, selenium, and silver) by US EPA Methods 6020A and 7471B, TCLP VOCs by US EPA Method 5030C/8260C, TCLP semi-volatile organic compounds (SVOCs) by US EPA Method 8270D, reactivity by US EPA Methods 1030, 9010B, 9030B, and 9045D, TCLP herbicides and pesticides by US EPA Methods 8151A and 8081B, and total PCBs by US EPA Method 8082A.

Following the completion of all soil sampling, the remaining soil cuttings extracted from the borings were containerized in a 55-gallon drum for offsite disposal. ERG will complete the waste profile and dispose of the drum offsite at an approved facility.

## **6.0 PATHWAY EVALUATION**

The EGLE Generic Residential Cleanup Criteria (GRCC), under Part 201 of Michigan's Natural Resources and Environmental Protection Act, 1994 PA 451, as Amended (Part 201), were used for comparison to the Investigation Area analytical results. The exposure pathway criteria used for comparison to the soil sampling results are the drinking water protection (DWP), groundwater surface water interface protection (GSIP), direct contact (DC), finite source volatile soil inhalation (VSIC), soil volatilization to indoor air inhalation (SVIAI), and particulate soil inhalation (PSI). The exposure pathway criteria used for comparison to the groundwater sampling results are the drinking water protection (DWP), groundwater surface water interface protection (GSIP), groundwater volatilization to indoor air inhalation (GVIAC), and the Michigan Maximum Contaminant Levels (MCLs) for PFAS.

Additionally, the soil and groundwater samples analytical results were compared to EGLE's residential VIAP Screening Levels (SLs). The soil gas screening results were compared to both the lower explosive limit (LEL) and upper explosive limit (UEL) for methane.

## **7.0 SOIL AND GROUNDWATER CHARACTERISTICS**

The following sections describe the soil and groundwater conditions encountered during the investigation.

### **7.1 Soil**

The subsurface lithology encountered beneath the surface cover (topsoil or concrete) was classified as a sand, sandy silt, or silty sand stratum that extended as deep as 12 to 16 feet bgs, the explored depth of the borings. Within this stratum, a sandy clay (2.5-3') and a silty clay (5.5-6') were observed in SB-1, and a silty clay (3-4') was observed in SB-2.

No staining, fill debris, or odors were encountered in the borings. In addition, no VOCs were detected on the PID during screening of the soil cores. For more detail on the encountered stratigraphy, refer to the boring logs included as Attachment D.

### **7.2 Groundwater**

Groundwater was encountered in all soil borings, with depths ranging from 2.5 feet bgs in SB-4-MW to 11 feet bgs in SB-2. ASTI conducted a groundwater elevation survey for monitoring wells SB-3-MW and SB-4-MW and found that groundwater flows northeast from SB-3-MW to SB-4-MW.

## **8.0 ANALYTICAL RESULTS**

The following sections summarize the analytical results for the soil, groundwater, and soil gas samples collected at the Investigation Area. The Laboratory Analytical Reports and Chain-of-Custody Documentation are provided in Attachment E.

### **Soil Analytical**

Table 1 presents the laboratory analytical results for the soil samples in comparison to the EGLE Part 201 GRCC and residential VIAP SLs.

### *Metals*

The laboratory analytical results reported arsenic in soil samples SB-1 (4-5'), SB-2 (10-11'), and SB-4 (1.5-2.5') at concentrations exceeding the GRCC for DWP, GSIP, and/or DC. However, these soil samples were collected in natural sand soils. Therefore, in accordance with 324.20101(e)(ii) of NREPA Act 451 of 1994 for use of regional background concentrations, the results for these samples can be compared to the regional background concentration of arsenic in sand in the Huron-Erie Glacial Lobe from the 2015 Michigan Background Soil Survey (updated January 2023). The regional background concentration for arsenic in sand is 22,800 micrograms per kilogram ( $\mu\text{g}/\text{kg}$ ). The maximum concentration of arsenic reported in the soil samples was 12,400  $\mu\text{g}/\text{kg}$  in sample SB-4 (1.5-2.5'), which is below the regional background concentration. Therefore, the arsenic concentrations in these samples do not represent exceedances of the GRCC.

Other metals were detected in the soil samples, but at concentrations below the GRCC and residential VIAP SLs.

### *PNAs, PCBs, VOCs, & PFAS*

The laboratory analytical results reported no PNAs, PCBs, VOCs, or PFAS in the soil samples at concentrations at or exceeding the laboratory reporting limits.

### Groundwater Analytical

Tables 2 and 3 present the laboratory analytical results for the groundwater samples in comparison to the EGLE Part 201 GRCC, residential VIAP SLs, and MCLs.

### *Metals*

The metals barium, copper, and zinc were reported in the groundwater samples, but at concentrations below the GRCC. No other metals were detected in the groundwater samples at concentrations at or exceeding the laboratory reporting limits.

### *PNAs, PCBs, & VOCs*

No PNAs, PCBs, or VOCs were detected in the groundwater samples at concentrations at or exceeding the laboratory reporting limits.

### *Dissolved Methane*

Dissolved methane was detected in each of the groundwater samples at concentrations above the laboratory reporting limits, but at concentrations below the GRCC and the residential VIAP SLs.

### *PFAS*

The laboratory analytical results reported perfluorooctanoic acid (PFOA) in groundwater sample SB-3-MW and its associated duplicate sample (DUP-1GW) at concentrations exceeding the MCL. Other PFAS were detected above the method detection limit in the groundwater samples, but at concentrations below the MCLs.

### Soil Gas Screening Results

Table 4 presents the screening results for the soil gas wells in comparison to the LEL and UEL for methane.

During screening, methane was detected in SG-1 at a concentration of 29% by volume, which exceeds the LEL and UEL. Methane was not detected in the remaining soil gas wells.

## **9.0 CONCLUSIONS AND RECOMMENDATIONS**

The laboratory analytical results for the samples collected at the Investigation Area reported PFOA in groundwater at concentrations exceeding the MCL. Therefore, ASTI recommends that groundwater removed from the Investigation Area be monitored for PFAS before being discharged to surface water or a water treatment plant. Additionally, because methane was reported in soil gas at a concentration exceeding the LEL, precautions must be taken by onsite personnel conducting groundwork in the Investigation Area to mitigate the explosive hazard.

On behalf of City of Rochester Hills, ASTI will prepare a Dewatering Monitoring and Contingency Plan for the Investigation Area to be followed during sewer extension activities.

## FIGURES

- 1 Site Location Map
- 2 Sample Location Map

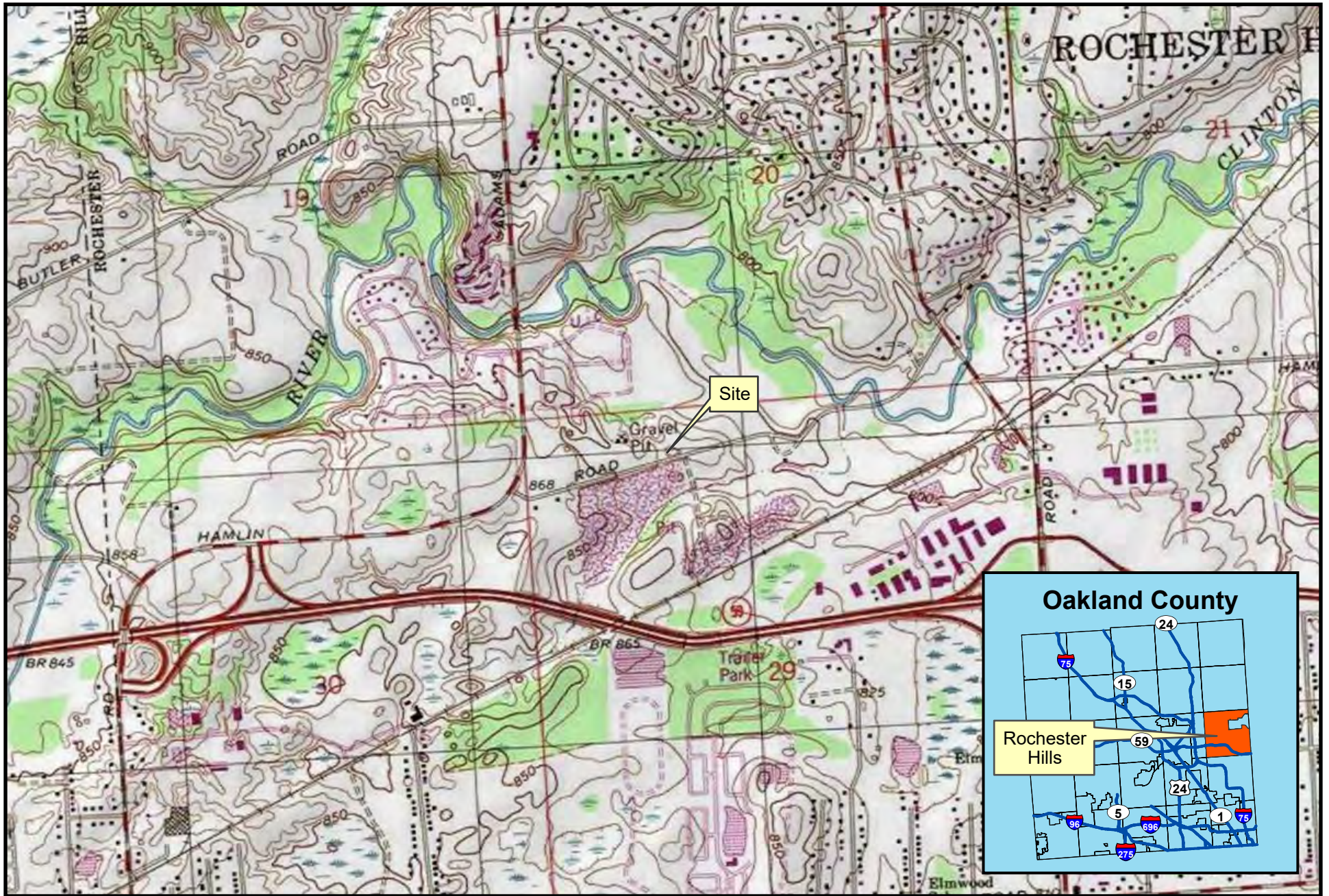

# Hamlin Road Sewer Extension

Rochester Hills, MI



Created for: City of Rochester Hills  
 Created by: RMH, June 27, 2024, ASTI Project A 24-3059.01

Figure 1 - Site Location Map

S:\Project Files\Current and Closed\13000-13999\13000-13099\13059 City of Rochester Hills\13059-2 Helen V Allen Park\CAD\A24-3059-01.dwg; B/19/2024 3:28 PM;

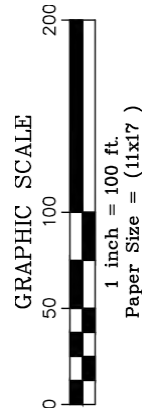
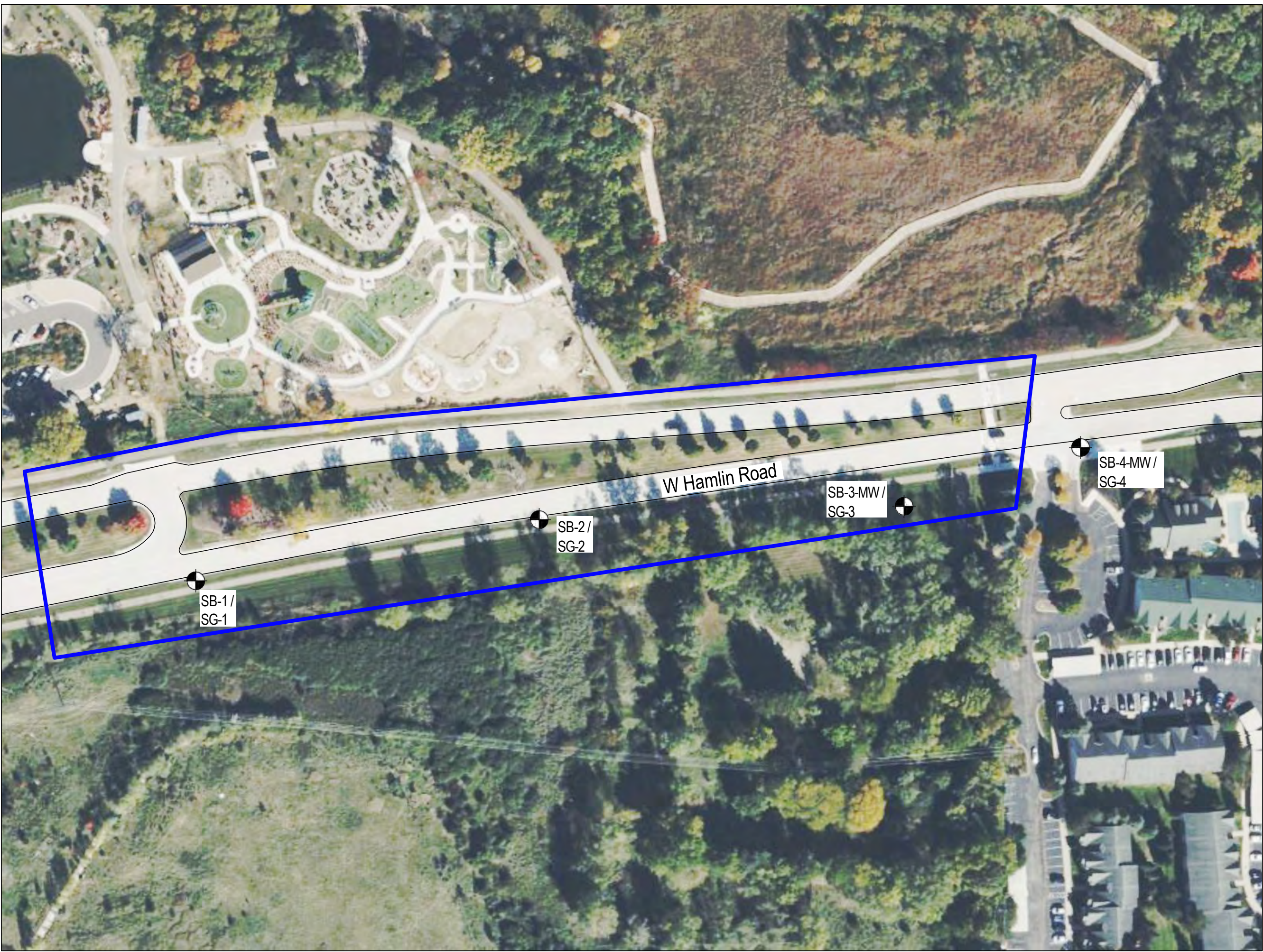

LEGEND

Approximate Investigation Area



Sample Location



## Hamlin Road Sewer Extension

Client: City of Rochester Hills  
ASTI Project A24-3059.01, JRN, June 19, 2024

Rochester Hills, MI



Figure 2 - Sample Location Map



## **TABLES**

- 1 Summary of Soil Sample Analytical Results
- 2 Summary of Groundwater PFAS Sample Analytical Results
- 3 Summary of Groundwater Sample Analytical Results
- 4 Summary of Soil Gas Screening Results

**Table 1 - Summary of Soil Sample Analytical Results**

Hamlin Road Sewer Extension, Rochester Hills, MI  
ASTI Project No. A24-3059.01

Parameters	Statewide Default Background Levels* µg/kg	Residential Drinking Water Protection Criteria* µg/kg	Groundwater Surface Water Interface Protection Criteria* µg/kg	Residential Soil Volatilization to Indoor Air Inhalation Criteria* µg/kg	Residential Finite Source Volatile Soil Inhalation for 5 Meter Source Thickness* µg/kg	Residential Particulate Soil Inhalation Criteria* µg/kg	Residential Direct Contact Criteria* µg/kg	Residential Volatilization to Indoor Air Pathway Screening Levels** µg/kg	SB-1 (4-5') 5/22/2024 µg/kg	SB-1 (10-11') 5/22/2024 µg/kg	SB-2 (9-10') 5/22/2024 µg/kg	SB-2 (10-11') 5/22/2024 µg/kg	SB-3 (9-10') 5/22/2024 µg/kg
<b>Metals</b>													
Arsenic	5,800	4,600	4,600	NLV	NLV	720,000	7,600	NA	8,820	3,800	4,300	6,100	4,920
Barium	75,000	1,300,000	(G)	NLV	NLV	330,000,000	37,000,000	NA	56,400	10,000	19,300	11,800	16,100
Cadmium	1,200	6,000	(G,X)	NLV	NLV	1,700,000	550,000	NA	360	<200	<200	<200	<200
Chromium, Total	18,000 (total)	30,000	3,300	NLV	NLV	260,000	2,500,000	NA	17,300	4,660	13,700	4,630	13,200
Copper	32,000	5,800,000	(G)	NLV	NLV	130,000,000	20,000,000	NA	19,500	6,800	8,670	7,930	9,150
Lead	21,000	700,000	(G,X)	NLV	NLV	100,000,000	400,000	NA	8,150	3,110	5,050	3,400	6,440
Mercury, Total	130	1,700	50 (M); 1.2	48,000	52,000	20,000,000	160,000	22 (M)	<50	<50	<50	<50	<50
Selenium	410	4,000	400	NLV	NLV	130,000,000	2,600,000	NA	<400	<400	<400	<400	<400
Silver	1,000	4,500	100 (M); 27	NLV	NLV	6,700,000	2,500,000	NA	<200	<200	<200	<200	<200
Zinc	47,000	2,400,000	(G)	NLV	NLV	ID	170,000,000	NA	56,500	22,200	35,400	22,900	28,300
<b>Polynuclear Aromatic Hydrocarbons (PNAs)</b>													
All Analyzed PNAs	CS	CS	CS	CS	CS	CS	CS	CS	<300	<300	<300	<300	<300
<b>Polychlorinated Biphenyls (PCBs)</b>													
All Analyzed PCBs	CS	CS	CS	CS	CS	CS	CS	CS	<330	<330	<330	<330	<330
<b>Volatile Organic Compounds (VOCs)</b>													
All Analyzed VOCs	CS	CS	CS	CS	CS	CS	CS	CS	<RL	<RL	<RL	<RL	<RL
<b>Per- and Polyfluoroalkyl Substances (PFAS)</b>													
All Analyzed PFAS	NA	NA	NA	NA	NA	NA	NA	NA	<RL	<RL	<RL	<RL	<RL

µg/kg - micrograms per kilogram

\*Per R299.46, October 12, 2023

\*\*Per VI Guidance Document, updated February 26, 2024

~ Parameter not tested for at this location.

CS - Compound specific.

<RL - Not detected. Below the laboratory reporting limit.

ID - Inadequate data to develop criterion.

NA - Not available.

NLV - Hazardous substance is not likely to volatilize under most conditions.

G - Groundwater Surface Water Interface (GSI) criterion depends on the pH or water hardness, or both, of the receiving surface water.

M - Calculated criterion is below the analytical target detection limit, therefore, the criterion defaults to the target detection limit.

X - The Groundwater Surface Water Interface (GSI) criterion shown in the generic cleanup criteria tables is not protective for surface water that is used as a drinking water source.

*Italicized* arsenic results exceed one or more GRCC, but are below the regional background concentration (22,800 µg/kg)

**Table 1 - Summary of Soil Sample Analytical Results**

Hamlin Road Sewer Extension, Rochester Hills, MI  
ASTI Project No. A24-3059.01

Parameters	Statewide Default Background Levels* µg/kg	Residential Drinking Water Protection Criteria* µg/kg	Groundwater Surface Water Interface Protection Criteria* µg/kg	Residential Soil Volatilization to Indoor Air Inhalation Criteria* µg/kg	Residential Finite Source Volatile Soil Inhalation for 5 Meter Source Thickness* µg/kg	Residential Particulate Soil Inhalation Criteria* µg/kg	Residential Direct Contact Criteria* µg/kg	Residential Volatilization to Indoor Air Pathway Screening Levels** µg/kg	SB-3 (10-11') 5/22/2024 µg/kg	SB-4 (1.5-2.5') 5/22/2024 µg/kg	SB-4 (10-11') 5/22/2024 µg/kg	DUP-1S SB-4 (10-11') 5/22/2024 µg/kg	Methanol Blank 5/22/2024 µg/kg
<b>Metals</b>													
Arsenic	5,800	4,600	4,600	NLV	NLV	720,000	7,600	NA	4,580	12,400	2,980	2,690	~
Barium	75,000	1,300,000	(G)	NLV	NLV	330,000,000	37,000,000	NA	11,000	41,700	6,920	6,420	~
Cadmium	1,200	6,000	(G,X)	NLV	NLV	1,700,000	550,000	NA	<200	<200	<200	<200	~
Chromium, Total	18,000 (total)	30,000	3,300	NLV	NLV	260,000	2,500,000	NA	7,110	12,500	3,940	3,250	~
Copper	32,000	5,800,000	(G)	NLV	NLV	130,000,000	20,000,000	NA	11,600	15,400	4,490	4,280	~
Lead	21,000	700,000	(G,X)	NLV	NLV	100,000,000	400,000	NA	4,930	6,550	2,170	1,970	~
Mercury, Total	130	1,700	50 (M); 1.2	48,000	52,000	20,000,000	160,000	22 (M)	<50	<50	<50	<50	~
Selenium	410	4,000	400	NLV	NLV	130,000,000	2,600,000	NA	<400	<400	<400	<400	~
Silver	1,000	4,500	100 (M); 27	NLV	NLV	6,700,000	2,500,000	NA	<200	<200	<200	<200	~
Zinc	47,000	2,400,000	(G)	NLV	NLV	ID	170,000,000	NA	25,300	45,100	16,800	15,700	~
<b>Polynuclear Aromatic Hydrocarbons (PNAs)</b>													
All Analyzed PNAs	CS	CS	CS	CS	CS	CS	CS	CS	<300	<300	<300	<300	~
<b>Polychlorinated Biphenyls (PCBs)</b>													
All Analyzed PCBs	CS	CS	CS	CS	CS	CS	CS	CS	<330	<330	<330	<330	~
<b>Volatile Organic Compounds (VOCs)</b>													
All Analyzed VOCs	CS	CS	CS	CS	CS	CS	CS	CS	<RL	<RL	<RL	<RL	<RL
<b>Per- and Polyfluoroalkyl Substances (PFAS)</b>													
All Analyzed PFAS	NA	NA	NA	NA	NA	NA	NA	NA	<RL	<RL	<RL	<RL	~

µg/kg - micrograms per kilogram

\*Per R299.46, October 12, 2023

\*\*Per VI Guidance Document, updated February 26, 2024

~ Parameter not tested for at this location.

CS - Compound specific.

<RL - Not detected. Below the laboratory reporting limit.

ID - Inadequate data to develop criterion.

NA - Not available.

NLV - Hazardous substance is not likely to volatilize under most conditions.

G - Groundwater Surface Water Interface (GSI) criterion depends on the pH or water hardness, or both, of the receiving surface water.

M - Calculated criterion is below the analytical target detection limit, therefore, the criterion defaults to the target detection limit.

X - The Groundwater Surface Water Interface (GSI) criterion shown in the generic cleanup criteria tables is not protective for surface water that is used as a drinking water source.

*Italicized* arsenic results exceed one or more GRCC, but are below the regional background concentration (22,800 µg/kg)

**Table 2 - Summary of Groundwater PFAS Sample Analytical Results**  
Hamlin Road Sewer Extension, Rochester Hills, MI  
ASTI Project No. A24-3059.01

Parameters	Michigan Maximum Contaminant Levels* ng/L	DUP-1GW		
		SB-3-MW 5/23/2024 ng/L	SB-3-MW 5/23/2024 ng/L	SB-4-GW 5/23/2024 ng/L
Perfluorobutanoic acid (PFBA)	NA	32	30	30
Perfluoropentanoic acid (PFPeA)	NA	4.3	<4.1	<4.2
4:2 Fluorotelomer Sulfonic Acid (4:2 FTSA)	NA	<2.0	<2.1	<2.1
Perfluorohexanoic acid (PFHxA)	400,000	5.5	6	4.9
Perfluorobutanesulfonic acid (PFBS)	420	2.5	3.1	4.1
Perfluoroheptanoic acid (PFHpA)	NA	4.0	3.9	<2.1
Perfluoropentanesulfonic acid (PFPeS)	NA	<2.0	<2.1	<2.1
6:2 Fluorotelomer Sulfonic Acid (6:2 FTSA)	NA	<2.0	<2.1	<2.1
Perfluorooctanoic acid (PFOA)	<b>8</b>	<b>91</b>	<b>86</b>	3.5
Perfluorohexanesulfonic acid (PFHxS)	51	3.0	3.5	2.2
Perfluorohexanesulfonic acid linear (PFHxS-LN)	NA	2.1	2.6	<2.1
Perfluorohexanesulfonic acid branched (PFHxS-BR)	NA	<2.0	<2.1	<2.1
Perfluorononanoic acid (PFNA)	6	<2.0	<2.1	<2.1
8:2 Fluorotelomer Sulfonic Acid (8:2 FTSA)	NA	<2.0	<2.1	<2.1
Perfluoroheptanesulfonic Acid (PFHpS)	NA	<2.0	<2.1	<2.1
Perfluorodecanoic acid (PFDA)	NA	<2.0	<2.1	<2.1
N-methyl perfluorooctanesulfonamidoacetic acid (N-MeFOSAA)	NA	<2.0	<2.1	<2.1
N-Ethyl Perfluorooctane Sulfonamidoacetic Acid (EtFOSAA)	NA	<4.0	<4.1	<4.2
Perfluorooctanesulfonic acid (PFOS)	16	11.0	12	<2.1
Perfluorooctanesulfonic acid linear (PFOS-LN)	NA	4.8	4.6	<2.1
Perfluorooctanesulfonic acid branched (PFOS-BR)	NA	5.0	6.3	<2.1
Perfluoroundecanoic acid (PFUnDA)	NA	<2.0	<2.1	<2.1
Perfluorononane Sulfonic Acid (PFNS)	NA	<2.0	<2.1	<2.1
Perfluorododecanoic Acid (PFDoDA)	NA	<2.0	<2.1	<2.1
Perfluorodecane Sulfonic Acid (PFDS)	NA	<2.0	<2.1	<2.1
Perfluorotridecanoic Acid (PFTrDA)	NA	<2.0	<2.1	<2.1
Perfluorooctanesulfonamide (FOSA)	NA	<2.0	<2.1	<2.1
Perfluorotetradecanoic Acid (PFTeDA)	NA	<4.0	<4.1	<4.2
11-chloroeicosafuoro-3-oxaundecane-1-sulfonic acid (11Cl-PF3OUdS)	NA	<2.0	<2.1	<2.1
9-chlorohexadecafluoro-3-oxanone-1-sulfonic acid (9Cl-PF3ONS)	NA	<2.0	<2.1	<2.1
4,8-dioxa-3H-perfluorononanoic acid (ADONA)	NA	<2.0	<2.1	<2.1
Hexafluoropropylene oxide dimer (HFPO-DA) [GenX]	370	<10	<10	<11

\* Michigan PFAS MCLs adopted August 3, 2020

**Bold/highlighted** results exceed the MCLs

NA - Not Available

ng/L = nanograms per liter

**Table 3 - Summary of Groundwater Sample Analytical Results**

Hamlin Road Sewer Extension, Rochester Hills, MI

ASTI Project No. A24-3059.01

Parameters	Residential	Groundwater	Residential	Residential	SB-3-MW	DUP-1GW	SB-4-MW
	Drinking	Surface Water	Groundwater				
	Water	Interface	Indoor Air	Volatilization to	5/23/2024	5/23/2024	5/23/2024
	Criteria*	Criteria	Inhalation	Indoor Air Pathway	µg/L	µg/L	µg/L
	µg/L	µg/L	µg/L	Screening Levels**			
<b>Metals</b>							
Arsenic	10 (A)	10	NLV	NA	<2	<2	<2
Barium	2,000 (A)	(G)	NLV	NA	71	69	94
Cadmium	5.0 (A)	(G,X)	NLV	NA	<0.5	<0.5	<0.5
Chromium, Total	100 (A)	11	NLV	NA	<5	<5	<5
Copper	1,000 (E)	(G)	NLV	NA	6	5	<5
Lead	4.0 (L)	(G,X)	NLV	NA	<3	<3	<3
Mercury, Total	2.0 (A)	0.0013	56 (S)	0.088	<0.2	<0.2	<0.2
Selenium	50 (A)	5.0	NLV	NA	<5	<5	<5
Silver	34	0.2 (M); 0.06	NLV	NA	<0.5	<0.5	<0.5
Zinc	2,400	(G)	NLV	NA	12	12	26
<b>Polynuclear Aromatic Hydrocarbons (PNA)</b>							
All Analyzed PNAs	CS	CS	CS	CS	<RL	<RL	<RL
<b>Polychlorinated Biphenyls (PCBs)</b>							
All Analyzed PCBs	CS	CS	CS	CS	<0.1	<0.1	<0.1
<b>Volatile Organic Compounds (VOCs)</b>							
All Analyzed VOCs	CS	CS	CS	CS	<RL	<RL	<RL
<b>Dissolved Methane</b>							
	ID	NA	(K)	10,000 (AA)	18	17	48

µg/L - micrograms per Liter

\*Per R299.44, October 12, 2023

\*\*Per VI Guidance Document, updated February 26, 2024

CS - Compound specific.

<RL - Not detected. Below the laboratory reporting limit.

ID - Inadequate data to develop criterion.

NA - Not available.

NLV - Hazardous substance is not likely to volatilize under most conditions.

A - Criterion is the State of Michigan drinking water standard established pursuant to Section 5.

E - Criterion is the aesthetic drinking water value, as required by Section 20120a(5) of the act.

G - Groundwater Surface Water Interface (GSI) criterion depends on the pH or water hardness, or both, of the receiving surface water.

L - Criteria for lead are derived using a biologically based model, as allowed for under Section 20120a(10)

of the act, and are not calculated using the algorithms and assumptions specified in pathway-specific rules.

S - Criterion defaults to the hazardous substance-specific water solubility limit.

X - The Groundwater Surface Water Interface (GSI) criterion shown in the generic cleanup criteria tables is not protective for surface water that is used as drinking water source.

AA - VIAP groundwater screening levels are not available due to insufficient toxicological data. Dissolved-phase methane in groundwater is not explosive; however, if liberated and allowed to accumulate in an enclosed structure the principle health and safety concerns are explosive, flammable, and asphyxiant properties of gas phase methane. The acceptable groundwater concentration is the flammability and explosivity screening level (FESL) is 10,000 µg/L.

K - Hazardous substance may be flammable or explosive, or both

**Table 4 - Summary of Soil Gas Screening Results**

Hamlin Road Sewer Extension, Rochester Hills, MI

ASTI Project No. A24-3059.01

Parameters	Lower Explosive Limit (% volume)	Upper Explosive Limit (% volume)	SG-1 (% volume)	SG-2 (% volume)	SG-3 (% volume)	SG-4 (% volume)
<b><i>Methane</i></b>	<b>5</b>	<b>15</b>	<b>29</b>	0	0	0

## **ATTACHMENTS**

**Attachment A**  
**Proposed Sewer Extension Plans**



BORE PIT NOTES:

- 1. BORE PIT WIDTH SHALL BE KEPT TO THE MINIMUM NECESSARY TO ALLOW CONSTRUCTION ACCESS.
- 2. BRACE AND/OR SUPPORT EXCAVATION AS NECESSARY TO CONTAIN EXCAVATION TO PLANNED DIMENSIONS.
- 3. PROVIDE ANY NECESSARY DEWATERING TO MAINTAIN A DRY WORKING SPACE.
- 4. BACKFILL BORE PIT WITH COMPACTED CLASS IIA SAND.

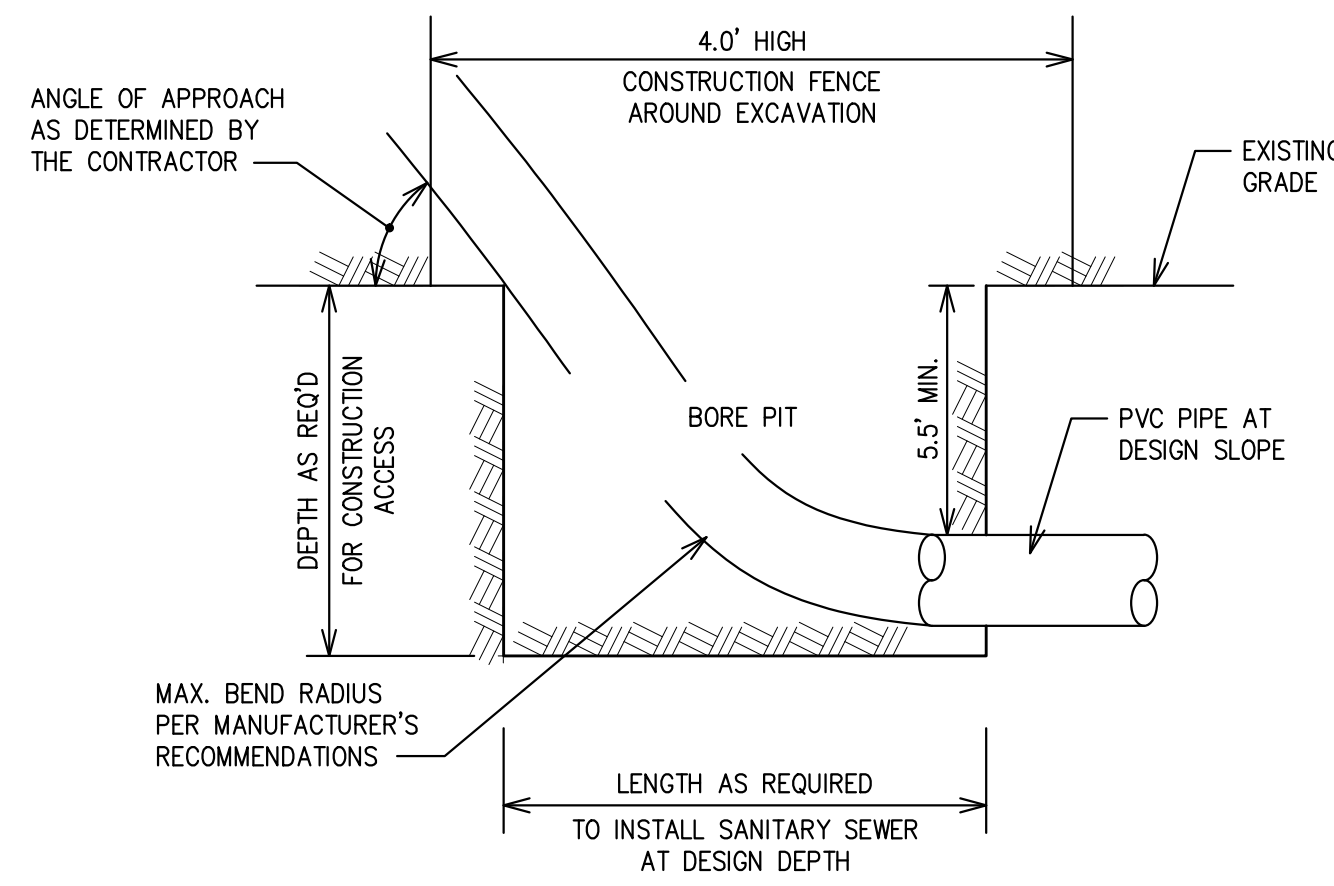

BORE PIT DETAIL  
NO SCALE

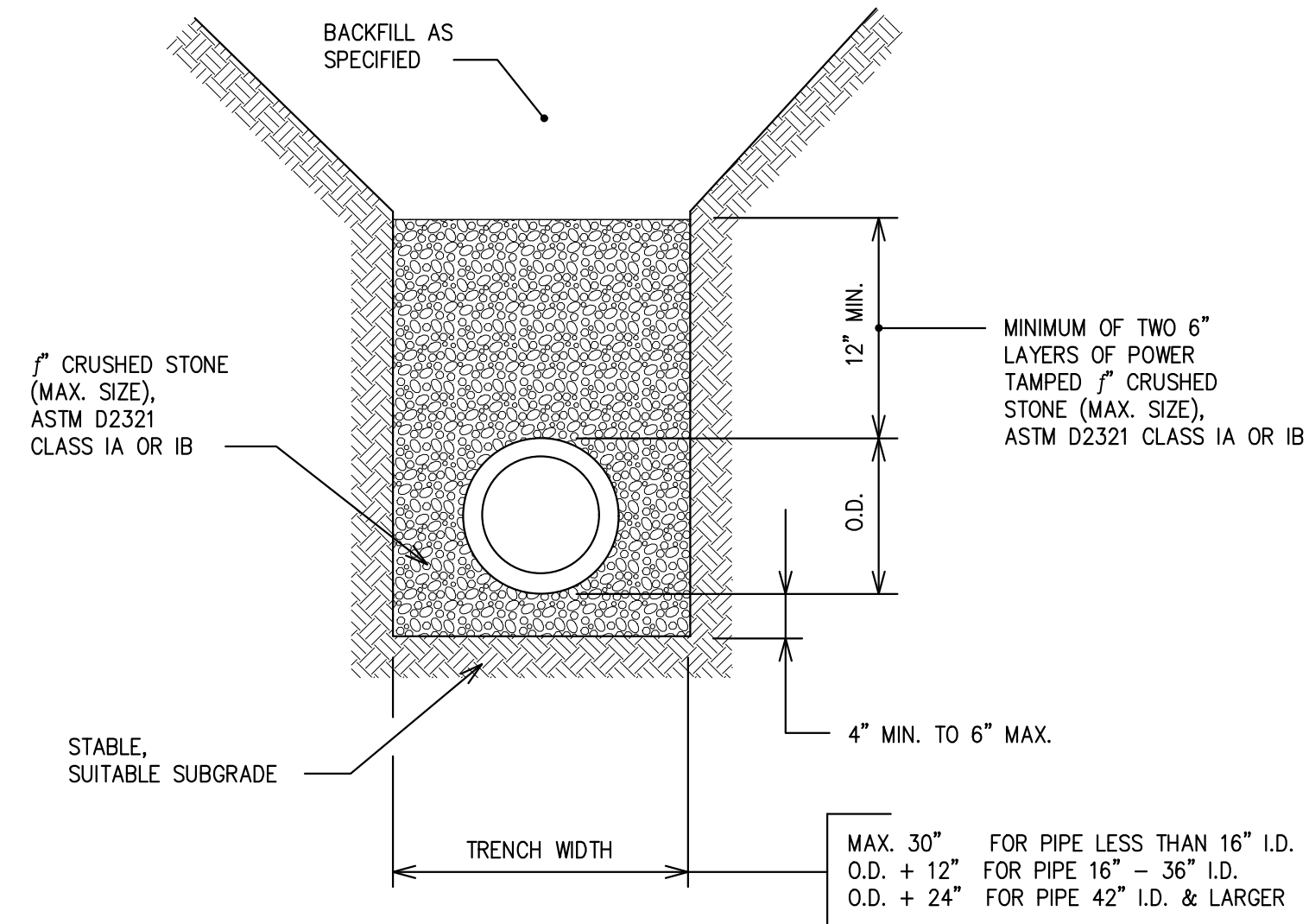

NOTE:  
USE CLASS IB WHEN LOCATED BENEATH GROUNDWATER TABLE.

STANDARD BEDDING FOR  
OPEN CUT PVC SANITARY SEWER  
NO SCALE

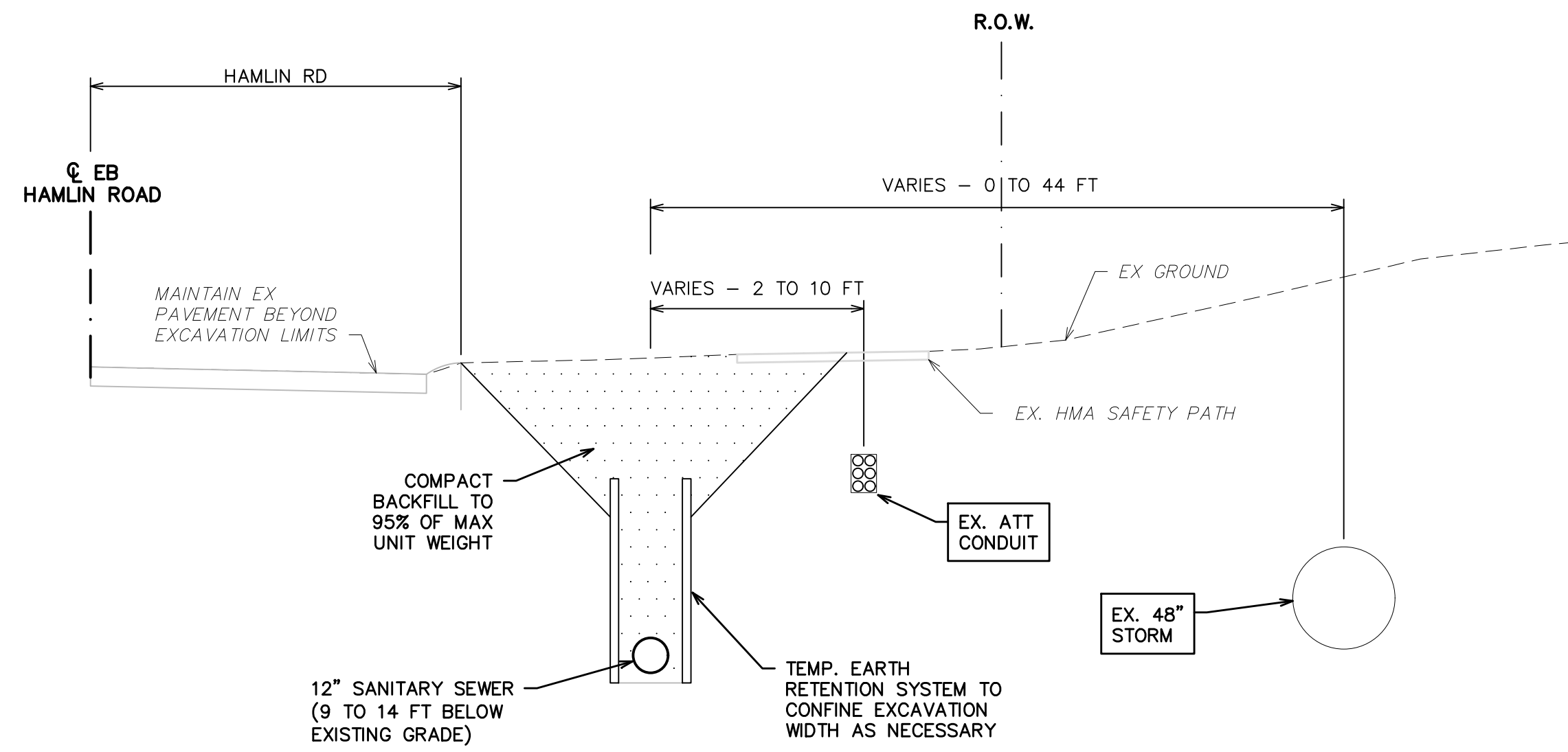

TYPICAL TRENCH DETAIL

BURIED CONDUIT/WIRE PROTECTION AND SUPPORT:

THE CONTRACTOR IS RESPONSIBLE FOR PROTECTING THE EXISTING UTILITIES IN THE VICINITY OF THE PROPOSED WORK.

ATT BURIED FACILITIES ARE PRESENT OVER OR NEAR THE EXISTING SEWER BEING REPLACED.

COORDINATE WITH ATT REPRESENTATIVES TO LOCATE THE CONDUIT OR WIRE AND THE PROPOSED APPROACH FOR SUPPORTING THEIR FACILITIES DURING CONSTRUCTION.

SUPPORT CONDUIT OR WIRE IN A MANNER ACCEPTABLE TO ATT TO FACILITATE EXCAVATION WORK NECESSARY TO INSTALL THE PROPOSED SEWER AND APPURTENANCES.

UPON COMPLETION OF SEWER WORK, BACKFILL EXCAVATIONS TO AN ELEVATION THAT WILL PROVIDE SUPPORT TO THE CONDUIT. REMOVE SUPPORTS AND CONTINUE BACKFILL TO DESIGN GRADES.

BACKFILL MUST BE COMPACTED IN ACCORDANCE WITH THE MDOT DENSITY TESTING AND INSPECTION MANUAL. LOWER INTENSITY COMPACTION EQUIPMENT MUST BE USED WHEN COMPACTING SOILS NEAR THE CONDUIT OR WIRE.



**HRC**  
**HUBBELL, ROTH & CLARK, INC**  
 CONSULTING ENGINEERS SINCE 1915  
 555 HULET DRIVE P.O. BOX 824  
 BLOOMFIELD HILLS, MICH. 48303 - 0824  
 PHONE: (248) 454-6300  
 FAX (1st. Floor): (248) 454-6312  
 FAX (2nd. Floor): (248) 454-6359  
 WEB SITE: www.hrcengr.com

DATE	ADDITIONS AND/OR REVISIONS
DESIGNED	RAD
DRAWN	RAD
CHECKED	JJS
APPROVED	JJS

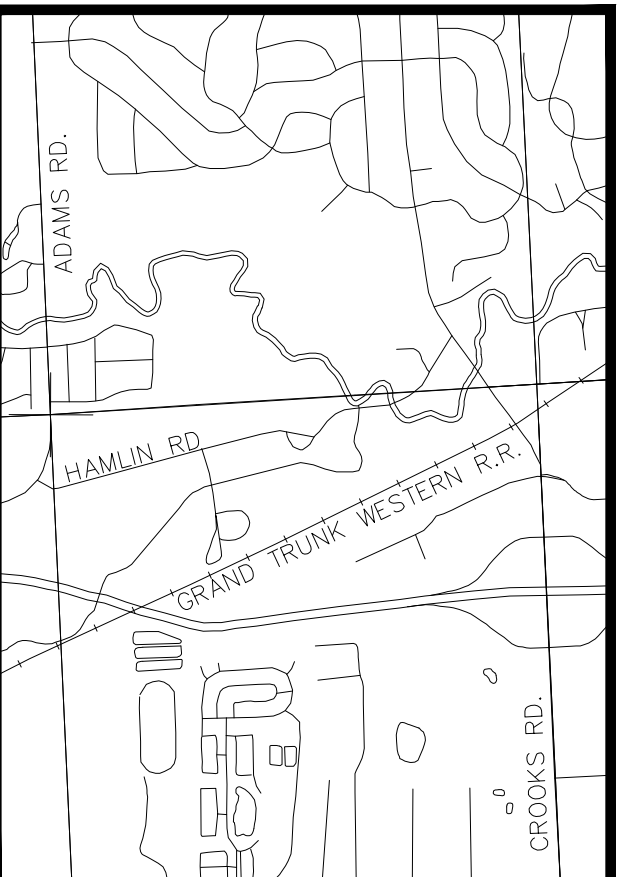

CITY OF ROCHESTER HILLS  
INNOVATION HILLS  
RESTROOM SEWER  
EXTENSION

SPECIAL PROJECT  
DETAILS

HRC JOB NO.	SCALE
20220926	NO SCALE
DATE	SHEET NO.
February 2024	C

NOTICE:  
 ALL EXISTING UTILITIES SHOWN ON THIS TOPOGRAPHIC SURVEY HAVE BEEN TAKEN FROM VISUAL OBSERVATION AND RECORD MAPPING WHERE AVAILABLE. NO GUARANTEE IS MADE, OR SHOULD BE ASSUMED, AS TO THE COMPLETENESS OR ACCURACY OF THE UTILITIES SHOWN ON THIS DRAWING. PARTIES UTILIZING THIS INFORMATION SHALL FIELD VERIFY



CALL MISS DIG  
 72 HOURS  
 (3 WORKING DAYS)  
 BEFORE YOU DIG  
 1-800-482-7171  
 or 811  
 (TOLL FREE)

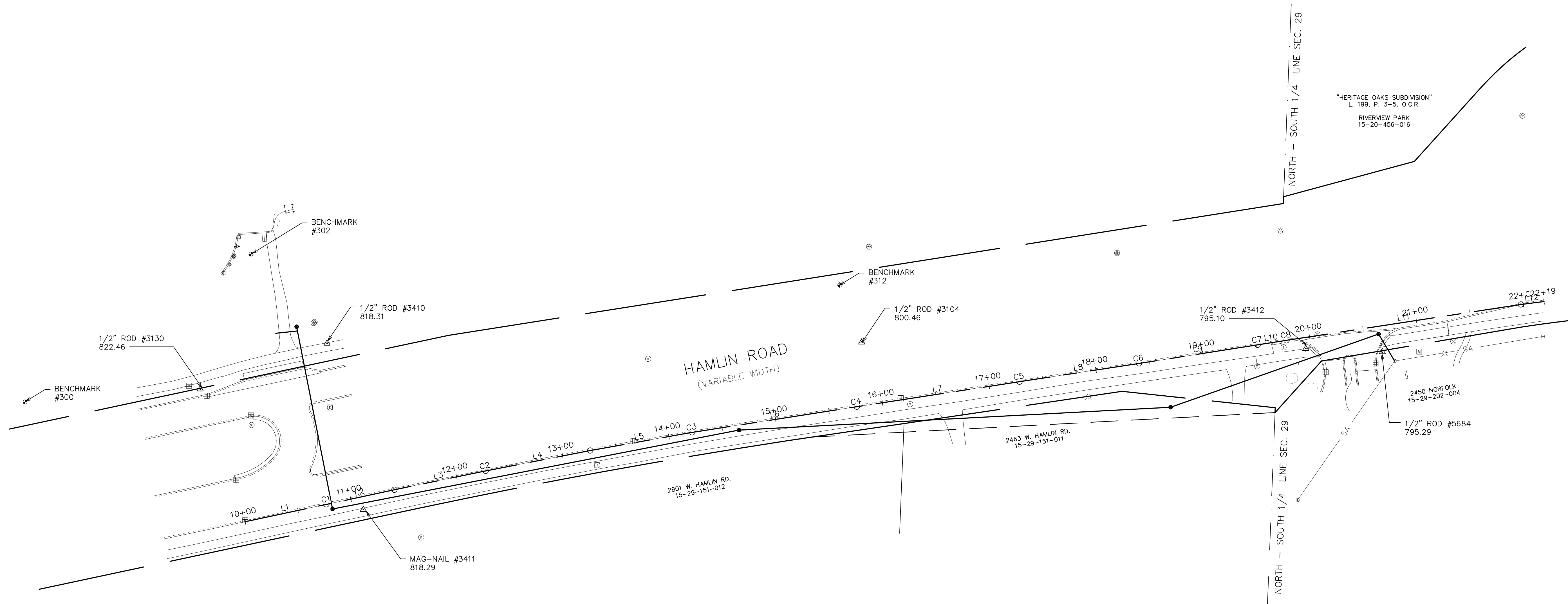
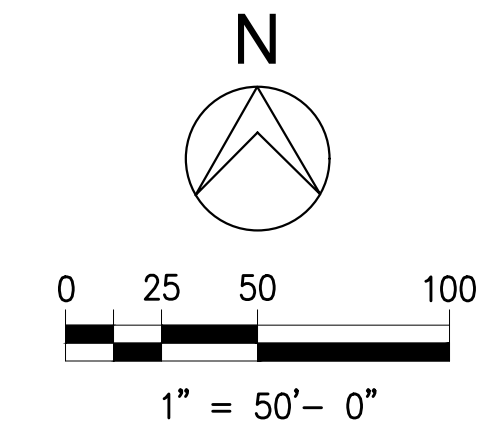

CONSTRUCTION CENTERLINE LAYOUT				
Line #	Direction	Length	Start	End
L1	N77° 57' 24"E	76.66'	N 421144.0555 E 13441338.8480	N 421160.0515 E 13441413.8233
L2	N77° 49' 48"E	64.12'	N 421160.1441 E 13441414.2550	N 421173.6604 E 13441476.9295
L3	N78° 20' 17"E	85.12'	N 421173.6604 E 13441476.9295	N 421190.8671 E 13441560.2962
L4	N78° 59' 37"E	97.43'	N 421191.3168 E 13441562.5398	N 421209.9187 E 13441658.1807
L5	N79° 51' 22"E	93.67'	N 421209.9187 E 13441658.1807	N 421226.4160 E 13441750.3872
L6	N81° 08' 17"E	151.61'	N 421227.1548 E 13441754.8005	N 421250.5106 E 13441904.5983
L7	N81° 15' 03"E	152.09'	N 421250.5106 E 13441904.5983	N 421273.7048 E 13442055.3040
L8	N81° 19' 08"E	111.31'	N 421273.7048 E 13442055.3040	N 421290.5406 E 13442165.5700
L9	N81° 04' 34"E	110.75'	N 421290.5406 E 13442166.4079	N 421307.8498 E 13442275.8150
L10	N81° 04' 46"E	26.57'	N 421307.8516 E 13442275.8265	N 421311.9714 E 13442302.0735
L11	N81° 19' 00"E	218.91'	N 421312.0981 E 13442302.8915	N 421345.1487 E 13442519.2969
L12	N82° 34' 29"E	21.66'	N 421345.1487 E 13442519.2969	N 421347.9479 E 13442540.7752

CONSTRUCTION CENTERLINE LAYOUT						
Curve #	Radius	Length	Chord Direction	PC	PI	PT
C1	200.00'	'0.44'	N77°53'36"E	N 421160.0515 E 13441413.8233	N 421160.0975 E 13441414.0392	N 421160.1441 E 13441414.2550
C2	200.00'	'2.29'	N78°39'57"E	N 421190.8671 E 13441560.2962	N 421191.0984 E 13441561.4167	N 421191.3168 E 13441562.5398
C3	200.00'	'4.47'	N80°29'50"E	N 421226.4160 E 13441750.3872	N 421226.8101 E 13441752.5897	N 421227.1548 E 13441754.8005
C4	200.00'	'0.39'	N81°11'40"E	N 421250.5106 E 13441904.5983	N 421250.5409 E 13441904.7926	N 421250.5708 E 13441904.9869
C5	200.00'	'0.24'	N81°17'06"E	N 421273.7048 E 13442055.3040	N 421273.7230 E 13442055.4218	N 421273.7410 E 13442055.5397
C6	200.00'	'0.85'	N81°11'51"E	N 421290.5406 E 13442165.5700	N 421290.6046 E 13442165.9891	N 421290.6704 E 13442166.4079
C7	200.00'	'0.01'	N81°04'40"E	N 421307.8498 E 13442275.8150	N 421307.8507 E 13442275.8207	N 421307.8516 E 13442275.8265
C8	200.00'	'0.83'	N81°11'53"E	N 421311.9714 E 13442302.0735	N 421312.0356 E 13442302.4823	N 421312.0981 E 13442302.8915

BENCHMARK		
BM NO.	ELEVATION	DESCRIPTION
300	828.45	
302	818.83	MAG NAIL ON TREE, 95' +/- NORTH OF ACCESS DRIVE
312	800.08	MAG NAIL IN SIDEWALK

TRAVERSE POINTS		
PT NO.	ELEVATION	DESCRIPTION
3104	800.46	N: 421310.1660 E: 13441909.2931
3130	822.46	N: 421266.7766 E: 13441297.2885
3410	818.31	N: 421309.1226 E: 13441414.5972
3411	818.29	N: 421155.1937 E: 13441448.1514
3412	795.10	N: 421304.3100 E: 13442320.2653
5684	795.29	N: 421301.3160 E: 13442391.1426

STRUCT NO.	PROP. COORDINATES	
	NORTHING	EASTING
MH2	421324.2764	13441386.4206
MH3	421192.9055	13441610.5912
MH4	421226.1978	13441809.4889
MH5	421263.6499	13442060.7204
MH6	421298.5482	13442437.0793



**HRC**  
**HUBBELL, ROTH & CLARK, INC**  
 CONSULTING ENGINEERS SINCE 1915  
 555 HULET DRIVE  
 BLOOMFIELD HILLS, MICH. P.O. BOX 824  
 48303 - 0824  
 PHONE: (248) 454-6300  
 FAX (1st. Floor): (248) 454-6312  
 FAX (2nd. Floor): (248) 454-6359  
 WEB SITE: www.hrcengr.com

DATE	ADDITIONS AND/OR REVISIONS
DESIGNED	RAD
DRAWN	RAD
CHECKED	JJS
APPROVED	JJS

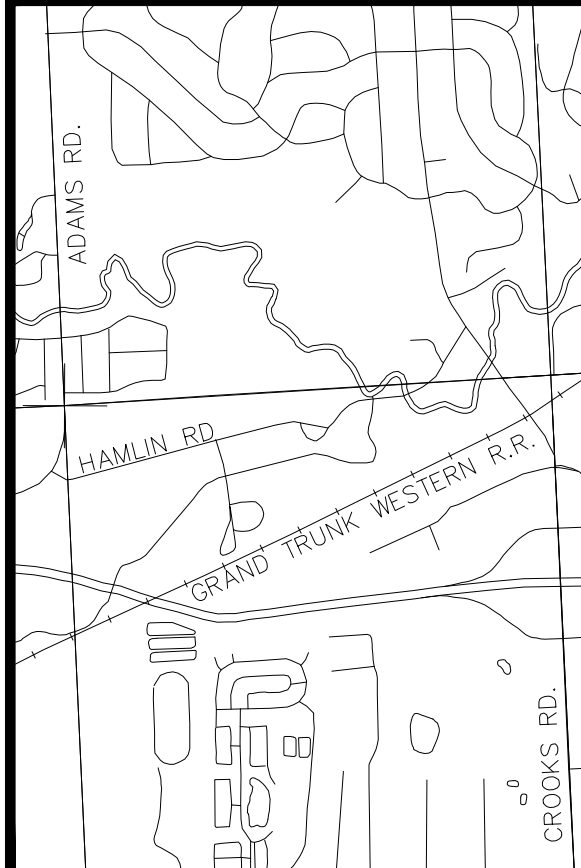

**CITY OF ROCHESTER HILLS**  
**INNOVATION HILLS**  
**RESTROOM SEWER**  
**EXTENSION**

**ALIGNMENT & EASEMENT PLAN**

HRC JOB NO. 20220926	SCALE 1" = 50'
DATE February 2024	SHEET NO. B OF

**NOTICE:**  
 ALL EXISTING UTILITIES SHOWN ON THIS TOPOGRAPHIC SURVEY HAVE BEEN TAKEN FROM VISUAL OBSERVATION AND RECORD MAPPING WHERE AVAILABLE. NO GUARANTEE IS MADE, OR SHOULD BE ASSUMED, AS TO THE COMPLETENESS OR ACCURACY OF THE UTILITIES SHOWN ON THIS DRAWING. PARTIES UTILIZING THIS INFORMATION SHALL FIELD VERIFY



CALL MISS DIG  
 72 HOURS  
 (3 WORKING DAYS)  
 BEFORE YOU DIG  
 1-800-482-7171  
 or 811  
 (TOLL FREE)

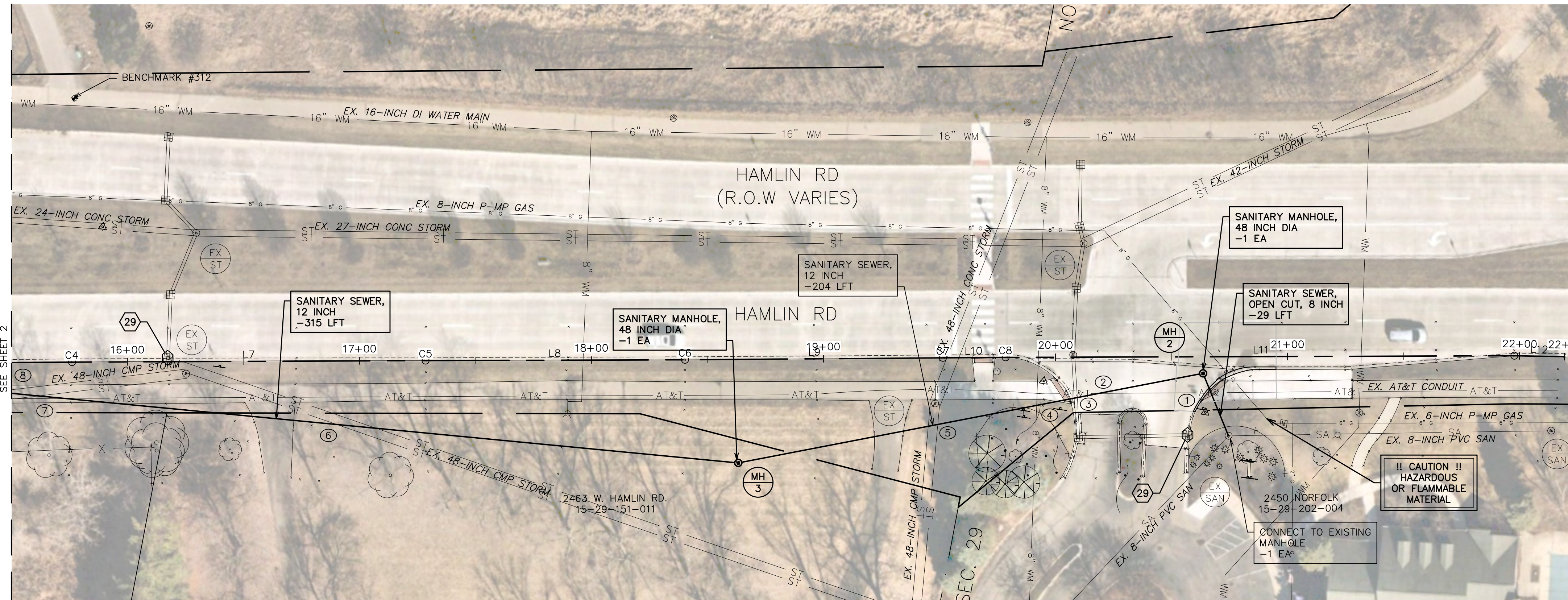

BENCH MARKS	
ELEVATION	DESCRIPTION
800.08'	BM #312 - MAG NAIL IN SIDEWALK

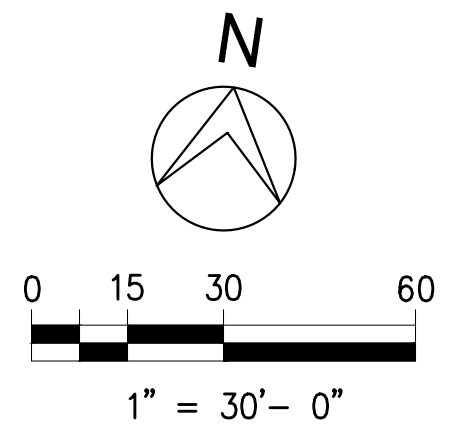

QUANTITIES THIS SHEET			
NO.	DESCRIPTION	UNIT	QTY
4	SIDEWALK, REM	SFT	238
5	PAVT, REM	SYD	132
6	CURB AND GUTTER, REM	LFT	45
10	SANITARY MANHOLE, 48 INCH DIA.	EA	2
12	SANITARY SEWER, 8 INCH, PVC CERTA-LOK DR26, OPEN CUT	LFT	29
13	SANITARY SEWER, 12 INCH, PVC CERTA-LOK DR26, HDD	LFT	519
14	CONNECT TO EXISTING MANHOLE	EA	1
17	CONC PAVT, NONREINF, 9 INCH, SPECIAL	SYD	90
18	DRIVEWAY, NONREINF CONC, 8 INCH	SYD	32
19	SIDEWALK, CONC, 4 INCH	SFT	236
20	SIDEWALK RAMP, CONC, 6 INCH	SYD	91
21	DETECTABLE WARNING SURFACE	FT	45
22	CURB AND GUTTER, CONC, DET F6	LFT	31
23	CURB RAMP OPENING, CONC	LFT	14

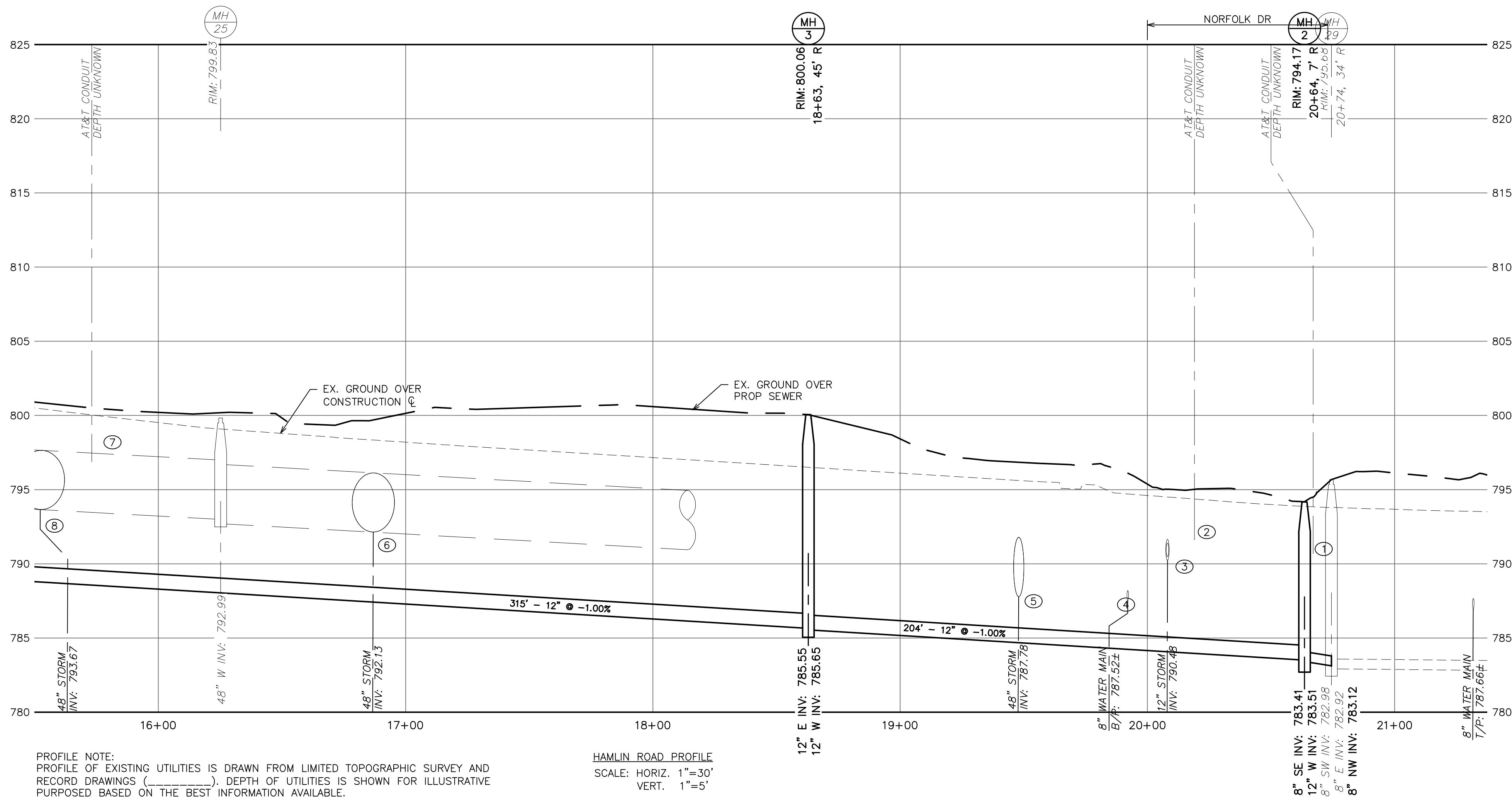

PROFILE NOTE:  
 PROFILE OF EXISTING UTILITIES IS DRAWN FROM LIMITED TOPOGRAPHIC SURVEY AND RECORD DRAWINGS ( ). DEPTH OF UTILITIES IS SHOWN FOR ILLUSTRATIVE PURPOSES BASED ON THE BEST INFORMATION AVAILABLE.

HAMLIN ROAD PROFILE  
 SCALE: HORIZ. 1"=30'  
 VERT. 1"=5'

UTILITY CROSSING DATA				UTILITY CROSSING DATA							
		CLEARANCE	GROUND ELEV.	SAN. DEPTH		CLEARANCE	GROUND ELEV.	SAN. DEPTH			
①	EXISTING AT&T PROPOSED 12" SAN	B/P 7XX.XX' T/P 783.98'	X'	794.49' ±	10.5' ±	⑤	EXISTING 48" STM PROPOSED 12" SAN	B/P 787.78' ± T/P 785.69'	2.1'	796.85' ±	9.7' ±
②	EXISTING AT&T PROPOSED 12" SAN	B/P 7XX.XX' T/P 784.96'	X'	795.01' ±	10.1' ±	⑥	EXISTING 48" STM PROPOSED 12" SAN	B/P 792.13' T/P 788.42'	3.7'	800.09' ±	9.5' ±
③	EXISTING 12" STM PROPOSED 12" SAN	B/P 795.03' T/P 785.07'	10.0'	795.03' ±	10' ±	⑦	EXISTING AT&T PROPOSED 12" SAN	B/P DEPTH UNK T/P 789.56'	X'	800.51' ±	10.2' ±
④	EXISTING 8" WM PROPOSED 12" SAN	B/P 787.52' T/P 785.24'	2.3'	796.13' ±	9.9' ±	⑧	EXISTING 48" STM PROPOSED 12" SAN	B/P 793.67' T/P 789.77'	3.9'	800.86' ±	10.2' ±

PROPOSED SANITARY STRUCTURE SCHEDULE					
MH #	PROPOSED CENTER OF STRUCTURE		STRUCTURE DEPTH	DESCRIPTION	COVER TYPE
	STATION	OFFSET			
2	20+64	7' R	10.75'	SANITARY MANHOLE, 48 INCH DIA	1040 TYPE A
3	19+45	9' R	10.9'	SANITARY MANHOLE, 48 INCH DIA	1040 TYPE A

COVER NOTES:  
 EAST JORDAN HEAVY DUTY MATERIAL ASTM A48 CL.35  
 COVER WT., 150 LBS., CATALOG NO. 1040 TYPE A, "ROCHESTER HILLS SANITARY" COVER

**SANITARY SEWER NOTES:**

- THE CONSTRUCTION COVERED BY THESE PLANS SHALL CONFORM TO THE CITY OF ROCHESTER HILLS ENGINEERING DEPARTMENTS STANDARD SPECIFICATION WHICH ARE INCLUDED BY REFERENCE. THE OMISSION OF ANY CURRENT STANDARD DETAIL DOES NOT RELIEVE THE CONTRACTOR FROM THIS REQUIREMENT. THE WORK SHALL BE PERFORMED IN COMPLETE CONFORMANCE WITH CURRENT ENGINEERING STANDARD SPECIFICATIONS AND DETAILS.
- NEW SANITARY SEWER SHALL CONSIST OF ASTM D3034 SDR26 PIPE WITH WATER-TIGHT ELASTOMERIC GASKET PUSH-ON JOINTS, CLASS B BEDDING. DEFLECTION OF PVC PIPE AFTER INSTALLATION AND BACKFILL SHALL NOT EXCEED 5.0% OF THE PIPE DIAMETER.
- MANUFACTURED TEES SHALL BE USED AT ALL SERVICE CONNECTIONS WITH RISERS AND MANUFACTURED WYES SHALL BE USED AT ALL SERVICE CONNECTIONS WITHOUT RISERS.
- NEW SANITARY SERVICES SHALL CONSIST OF PVC SDR23.5 SOLID WALL PIPE WITH WATER-TIGHT GASKET JOINTS, STONE BEDDING AND BACKFILLED WITH COMPACTED SAND BACKFILL.
- TERMINATE NEW SANITARY SERVICES WITH A WATER-TIGHT PLUG AND 2" X 2" HARDWOOD STAKE AS REQUIRED BY SPECIFICATIONS.
- ALL SANITARY SEWER SHALL BE INSTALLED ACCORDING TO THE ASTM D2321 STANDARD.
- THE FOUNDATION FOR THE SANITARY SEWER CANNOT CONTAIN HIGHLY COMPRESSIBLE OR ORGANIC SOILS.
- THE FINAL BACKFILL SHALL NOT CONTAIN DEBRIS, FROZEN MATERIAL OR ORGANIC MATERIAL WITHIN TWO FEET OF THE TOP OF THE PIPE.
- A LASER SHALL BE USED FOR POSITIONING AND ALIGNMENT FOR INSTALLATION OF THE SANITARY SEWER.

**NOTE:**

- CONTRACTOR TO PROTECT ALL TREES AND OTHER LANDSCAPING NOT CALLED OUT FOR REMOVALS. TREES SHOWN FOR REMOVAL MAY BE SAVED IN SOME INSTANCES AND ARE TO BE REVIEWED ON A CASE BY CASE BASIS PRIOR TO ANY REMOVALS TAKING PLACE. NO REMOVALS ALLOWED WITHOUT PRE-AUTHORIZATION BY CITY AND ENGINEER.
- SUCCESSFUL AIR TEST AND POST CONSTRUCTION VIDEO (INCLUDED IN UNIT PRICE OF SANITARY SEWER) REQUIRED FOR FINAL PROJECT ACCEPTANCE.
- SEE PLAN SHEET NO. ### FOR PAVEMENT SECTION DETAILS.
- ALL NON-PAVEMENT RESTORATION TO BE GENERALLY IN-KIND. TURF RESTORATION SHALL BE MADE WITH CLASS A SOD AND TWO (2) INCHES OF TOPSOIL, OR SEED AND MULCH ON THREE (3) INCHES OF TOPSOIL FOR NON IRRIGATED AREAS.
- SANITARY SEWER TO BE CONSTRUCTED IN ACCORDANCE WITH CITY OF ROCHESTER HILLS STANDARD DETAILS.

**NOTICE:**  
 ALL EXISTING UTILITIES SHOWN ON THIS TOPOGRAPHIC SURVEY HAVE BEEN TAKEN FROM VISUAL OBSERVATION AND RECORD MAPPING WHERE AVAILABLE. NO GUARANTEE IS MADE, OR SHOULD BE ASSUMED, AS TO THE COMPLETENESS OR ACCURACY OF THE UTILITIES SHOWN ON THIS DRAWING. PARTIES UTILIZING THIS INFORMATION SHALL FIELD VERIFY.



CALL MISS DIG 72 HOURS (3 WORKING DAYS) BEFORE YOU DIG  
 1-800-482-7171 or 811 (TOLL FREE)

DATE	ADDITIONS AND/OR REVISIONS
DESIGNED	RAD
DRAWN	RAD
CHECKED	JJS
APPROVED	JJS

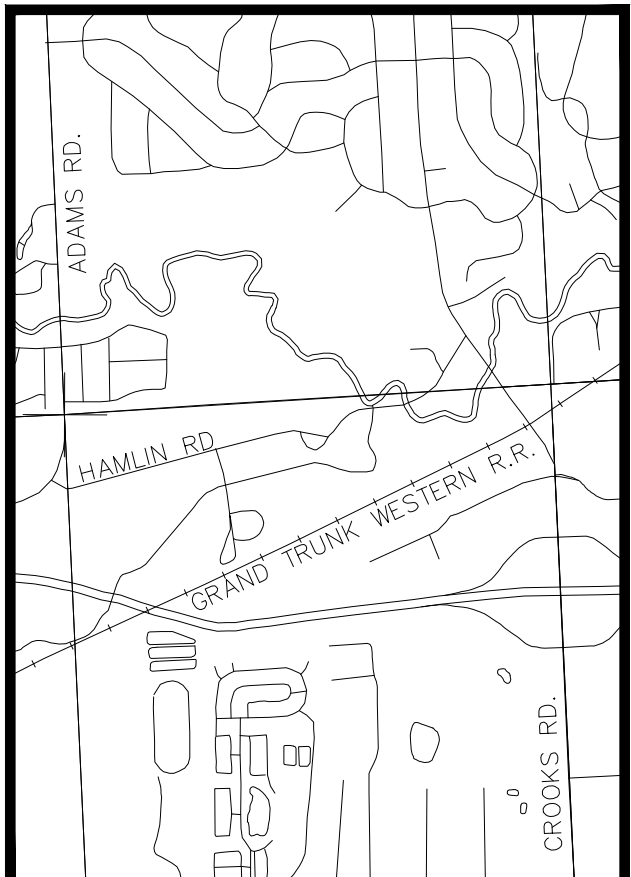

**CITY OF ROCHESTER HILLS**  
**INNOVATION HILLS RESTROOM SEWER EXTENSION**

**SANITARY SEWER 15+50 TO P.O.E.**

HRC-JOB NO. 20220926	SCALE 1" = 30'
DATE February 2024	SHEET NO. 1 OF

2/7/2024 3:51 PM

HRC\_01.w.ctb

V:\202209\20220926\C\Sheets\p02.dwg

Jonko, Rebecca

MATCH LINE - STA. 5+50  
SEE SHEET 3

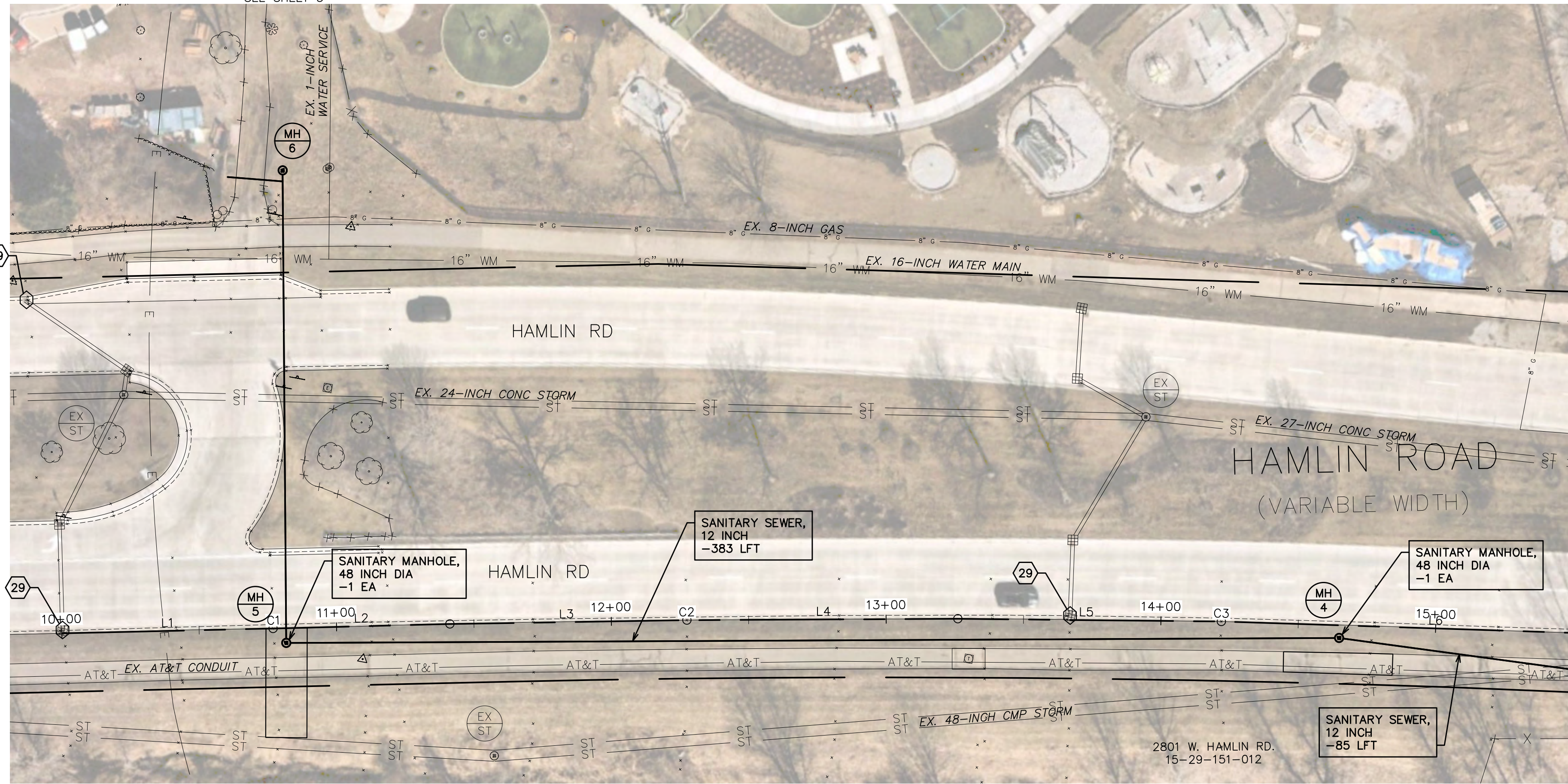

ELEVATION	BENCH MARKS DESCRIPTION
818.83'	BM #302 - MAG NAIL ON TREE, 95 +/- NORTH OF ACCESS DRIVE

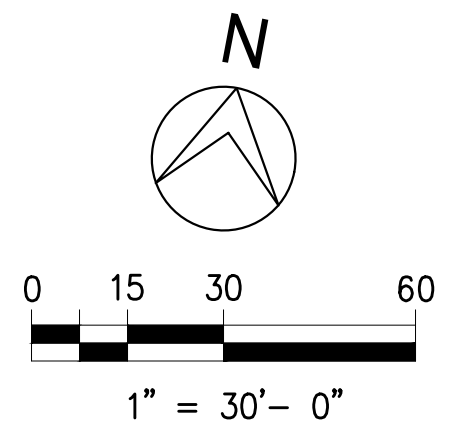

QUANTITIES THIS SHEET			
NO.	DESCRIPTION	UNIT	QTY
3	HMA, REM	SYD	604
10	SANITARY MANHOLE, 48 INCH DIA.	EA	2
13	SANITARY SEWER, 12 INCH, PVC CERTA-LOK DR26, HDD	LFT	468
15	HMA, 5EML, 1.5 INCH	SYD	67
16	HMA, 4EML, 2 INCH	SYD	67
24	21AA AGGREGATE BASE, 10 INCH, SPECIAL	TON	30

PROPOSED SANITARY STRUCTURE SCHEDULE					
MH #	PROPOSED CENTER OF STRUCTURE		STRUCTURE DEPTH	DESCRIPTION	COVER TYPE
	STATION	OFFSET			
4	14+65	5' R	13.1'	SANITARY MANHOLE, 48 INCH DIA	1040 TYPE A
5	10+82	5' R	13.7'	SANITARY MANHOLE, 48 INCH DIA	1040 TYPE A

COVER NOTES:  
EAST JORDAN HEAVY DUTY MATERIAL ASTM A48 CL35  
COVER WT., 150 LBS., CATALOG NO. 1040 TYPE A, "ROCHESTER HILLS SANITARY" COVER

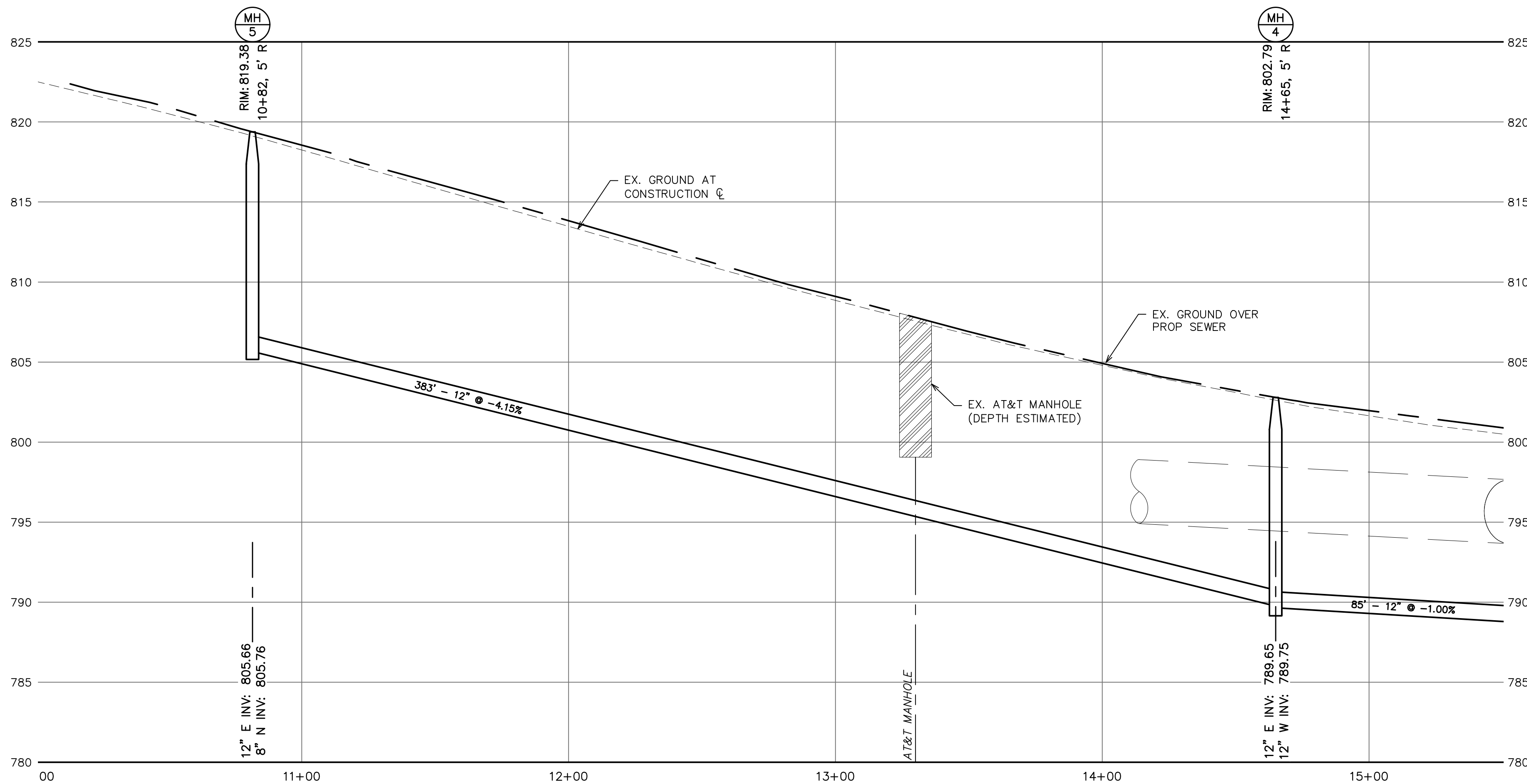

HAMLIN ROAD PROFILE  
SCALE: HORIZ. 1"=30'  
VERT. 1"=6'

PROFILE NOTE:  
PROFILE OF EXISTING UTILITIES IS DRAWN FROM LIMITED TOPOGRAPHIC SURVEY AND RECORD DRAWINGS (-----). DEPTH OF UTILITIES IS SHOWN FOR ILLUSTRATIVE PURPOSES BASED ON THE BEST INFORMATION AVAILABLE.

**SANITARY SEWER NOTES:**

- THE CONSTRUCTION COVERED BY THESE PLANS SHALL CONFORM TO THE CITY OF ROCHESTER HILLS ENGINEERING DEPARTMENTS STANDARD SPECIFICATION WHICH ARE INCLUDED BY REFERENCE. THE OMISSION OF ANY CURRENT STANDARD DETAIL DOES NOT RELIEVE THE CONTRACTOR FROM THIS REQUIREMENT. THE WORK SHALL BE PERFORMED IN COMPLETE CONFORMANCE WITH CURRENT ENGINEERING STANDARD SPECIFICATIONS AND DETAILS.
- NEW SANITARY SEWER SHALL CONSIST OF ASTM D3034 SDR26 PIPE WITH WATER-TIGHT ELASTOMERIC GASKET PUSH-ON JOINTS, CLASS B BEDDING. DEFLECTION OF PVC PIPE AFTER INSTALLATION AND BACKFILL SHALL NOT EXCEED 5.0% OF THE PIPE DIAMETER.
- MANUFACTURED TEES SHALL BE USED AT ALL SERVICE CONNECTIONS WITH RISERS AND MANUFACTURED WYES SHALL BE USED AT ALL SERVICE CONNECTIONS WITHOUT RISERS.
- NEW SANITARY SERVICES SHALL CONSIST OF PVC SDR23.5 SOLID WALL PIPE WITH WATER-TIGHT GASKET JOINTS, STONE BEDDING AND BACKFILLED WITH COMPACTED SAND BACKFILL.
- TERMINATE NEW SANITARY SERVICES WITH A WATER-TIGHT PLUG AND 2" X 2" HARDWOOD STAKE AS REQUIRED BY SPECIFICATIONS.
- ALL SANITARY SEWER SHALL BE INSTALLED ACCORDING TO THE ASTM D2321 STANDARD.
- THE FOUNDATION FOR THE SANITARY SEWER CANNOT CONTAIN HIGHLY COMPRESSIBLE OR ORGANIC SOILS.
- THE FINAL BACKFILL SHALL NOT CONTAIN DEBRIS, FROZEN MATERIAL OR ORGANIC MATERIAL WITHIN TWO FEET OF THE TOP OF THE PIPE.
- A LASER SHALL BE USED FOR POSITIONING AND ALIGNMENT FOR INSTALLATION OF THE SANITARY SEWER.

**NOTE:**

- CONTRACTOR TO PROTECT ALL TREES AND OTHER LANDSCAPING NOT CALLED OUT FOR REMOVALS. TREES SHOWN FOR REMOVAL MAY BE SAVED IN SOME INSTANCES AND ARE TO BE REVIEWED ON A CASE BY CASE BASIS PRIOR TO ANY REMOVALS TAKING PLACE. NO REMOVALS ALLOWED WITHOUT PRE-AUTHORIZATION BY CITY AND ENGINEER.
- SUCCESSFUL AIR TEST AND POST CONSTRUCTION VIDEO (INCLUDED IN UNIT PRICE OF SANITARY SEWER) REQUIRED FOR FINAL PROJECT ACCEPTANCE.
- SEE PLAN SHEET NO. ### FOR PAVEMENT SECTION DETAILS.
- ALL NON-PAVEMENT RESTORATION TO BE GENERALLY IN-KIND. TURF RESTORATION SHALL BE MADE WITH CLASS A SOD AND TWO (2) INCHES OF TOPSOIL, OR SEED AND MULCH ON THREE (3) INCHES OF TOPSOIL FOR NON IRRIGATED AREAS.
- SANITARY SEWER TO BE CONSTRUCTED IN ACCORDANCE WITH CITY OF ROCHESTER HILLS STANDARD DETAILS.

**NOTICE:**  
ALL EXISTING UTILITIES SHOWN ON THIS TOPOGRAPHIC SURVEY HAVE BEEN TAKEN FROM VISUAL OBSERVATION AND RECORD MAPPING WHERE AVAILABLE. NO GUARANTEE IS MADE, OR SHOULD BE ASSUMED, AS TO THE COMPLETENESS OR ACCURACY OF THE UTILITIES SHOWN ON THIS DRAWING. PARTIES UTILIZING THIS INFORMATION SHALL FIELD VERIFY.



CALL MISS DIG  
72 HOURS  
(3 WORKING DAYS)  
BEFORE YOU DIG  
1-800-482-7171  
or 811  
(TOLL FREE)



**HRC**  
**HUBBELL, ROTH & CLARK, INC**  
CONSULTING ENGINEERS SINCE 1915  
555 HULET DRIVE  
BLOOMFIELD HILLS, MICH. P.O. BOX 824  
48303 - 0824  
PHONE: (248) 454-6300  
FAX (1st Floor): (248) 454-6312  
FAX (2nd Floor): (248) 454-6359  
WEB SITE: www.hrcengr.com

DATE	ADDITIONS AND/OR REVISIONS
DESIGNED	RAD
DRAWN	RAD
CHECKED	JJS
APPROVED	JJS

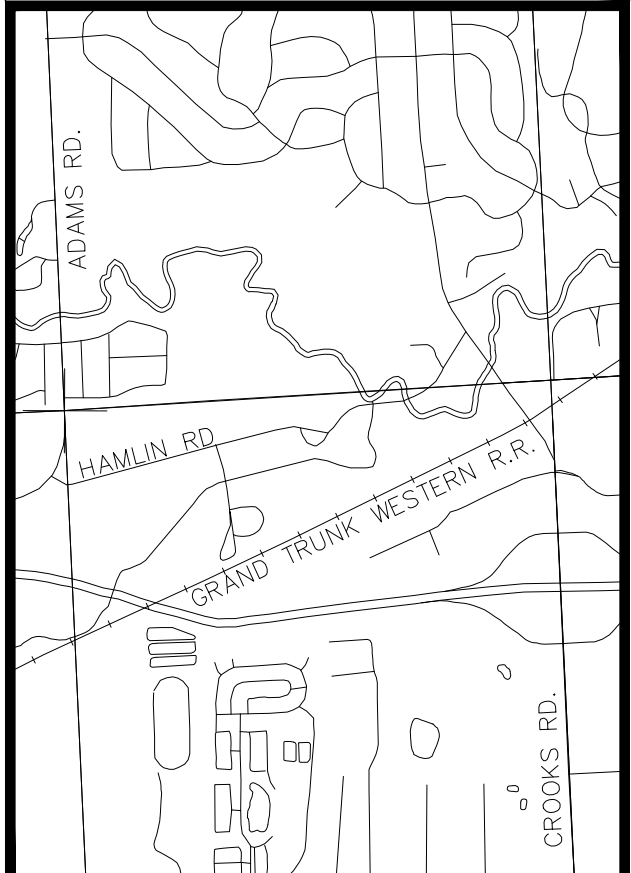

**CITY OF ROCHESTER HILLS**  
**INNOVATION HILLS**  
**RESTROOM SEWER**  
**EXTENSION**

SANITARY SEWER  
POB TO 15+50

HRC JOB NO.	SCALE
20220926	1" = 30'
DATE	SHEET NO.
February 2024	2 OF

2/7/2024 3:53 PM  
HRC\_01W.ctb  
V:\202209\20220926\C\Sheets\pp3.dwg  
Janke, Rebecca

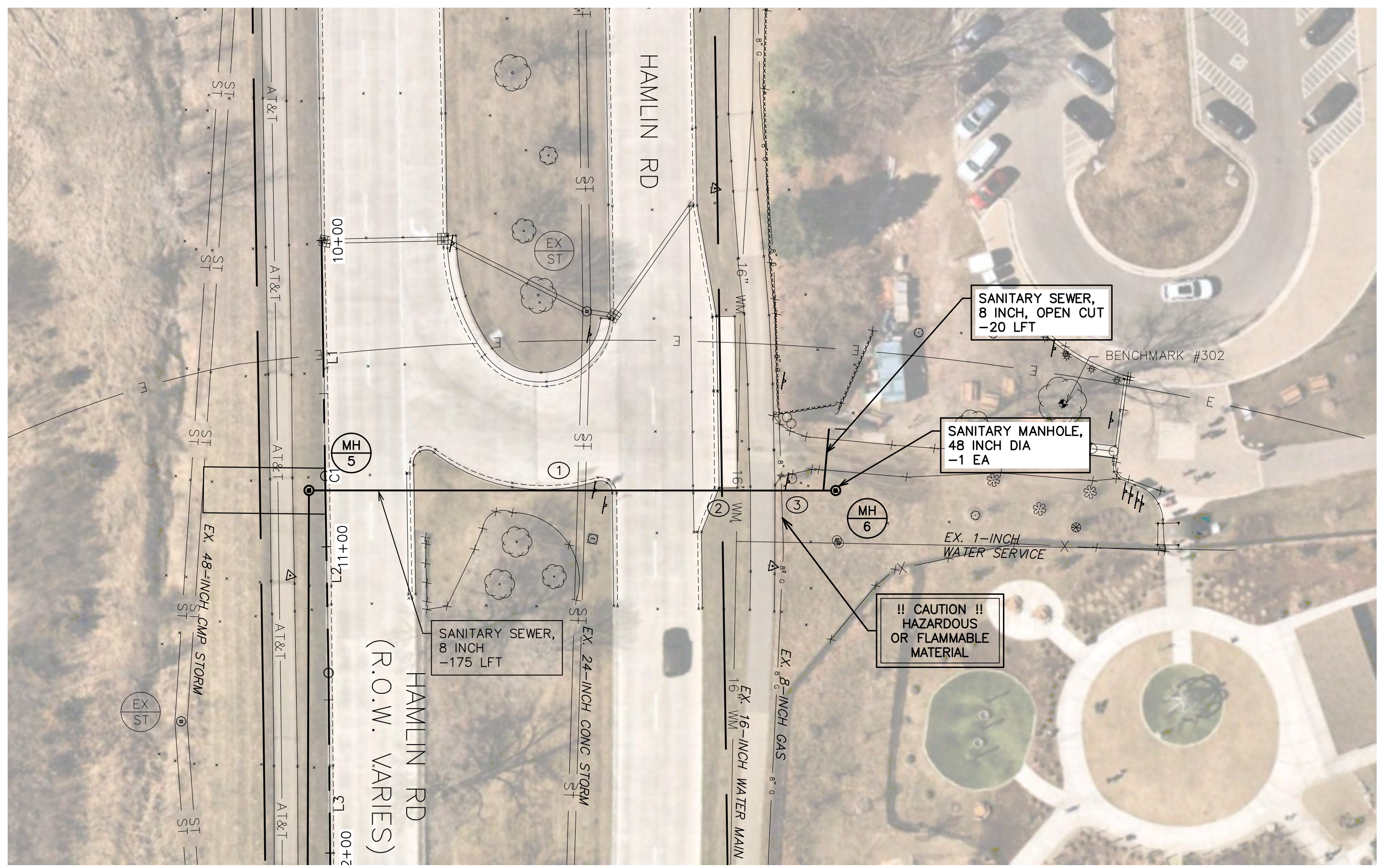

BENCH MARKS	
ELEVATION	DESCRIPTION
818.83'	BM #302 - MAG NAIL ON TREE, 95' +/- NORTH OF ACCESS DRIVE

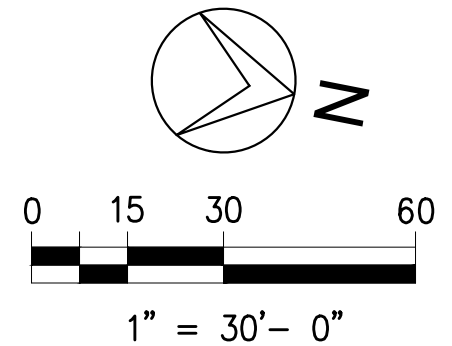

QUANTITIES THIS SHEET			
NO.	DESCRIPTION	UNIT	QTY.
10	SANITARY MANHOLE, 48 INCH DIA.	EA	1
11	SANITARY SEWER, 8 INCH, PVC CERTA-LOK DR26, HDD	LFT	175
12	SANITARY SEWER, 8 INCH, PVC CERTA-LOK DR26, OPEN CUT	LFT	20

PROPOSED SANITARY STRUCTURE SCHEDULE					
MH #	PROPOSED CENTER OF STRUCTURE		STRUCTURE DEPTH	DESCRIPTION	COVER TYPE
	STATION	OFFSET			
6	10+85	167' L	9'	SANITARY MANHOLE, 48 INCH DIA	1040 TYPE A

**COVER NOTES:**  
 EAST JORDAN HEAVY DUTY MATERIAL ASTM A48 CL.35  
 COVER WT., 150 LBS., CATALOG NO. 1040 TYPE A, "ROCHESTER HILLS SANITARY" COVER

**SANITARY SEWER NOTES:**

1. THE CONSTRUCTION COVERED BY THESE PLANS SHALL CONFORM TO THE CITY OF ROCHESTER HILLS ENGINEERING DEPARTMENTS STANDARD SPECIFICATION WHICH ARE INCLUDED BY REFERENCE. THE OMISSION OF ANY CURRENT STANDARD DETAIL DOES NOT RELIEVE THE CONTRACTOR FROM THIS REQUIREMENT. THE WORK SHALL BE PERFORMED IN COMPLETE CONFORMANCE WITH CURRENT ENGINEERING STANDARD SPECIFICATIONS AND DETAILS.
2. NEW SANITARY SEWER SHALL CONSIST OF ASTM D3034 SDR26 PIPE WITH WATER-TIGHT ELASTOMERIC GASKET PUSH-ON JOINTS, CLASS B BEDDING. DEFLECTION OF PVC PIPE AFTER INSTALLATION AND BACKFILL SHALL NOT EXCEED 5.0% OF THE PIPE DIAMETER.
3. MANUFACTURED TEES SHALL BE USED AT ALL SERVICE CONNECTIONS WITH RISERS AND MANUFACTURED WYES SHALL BE USED AT ALL SERVICE CONNECTIONS WITHOUT RISERS.
4. NEW SANITARY SERVICES SHALL CONSIST OF PVC SDR23.5 SOLID WALL PIPE WITH WATER-TIGHT GASKET JOINTS, STONE BEDDING AND BACKFILLED WITH COMPACTED SAND BACKFILL.
5. TERMINATE NEW SANITARY SERVICES WITH A WATER-TIGHT PLUG AND 2" X 2" HARDWOOD STAKE AS REQUIRED BY SPECIFICATIONS.
6. ALL SANITARY SEWER SHALL BE INSTALLED ACCORDING TO THE ASTM D2321 STANDARD.
7. THE FOUNDATION FOR THE SANITARY SEWER CANNOT CONTAIN HIGHLY COMPRESSIBLE OR ORGANIC SOILS.
8. THE FINAL BACKFILL SHALL NOT CONTAIN DEBRIS, FROZEN MATERIAL OR ORGANIC MATERIAL WITHIN TWO FEET OF THE TOP OF THE PIPE.
9. A LASER SHALL BE USED FOR POSITIONING AND ALIGNMENT FOR INSTALLATION OF THE SANITARY SEWER.

**NOTE:**

1. CONTRACTOR TO PROTECT ALL TREES AND OTHER LANDSCAPING NOT CALLED OUT FOR REMOVALS. TREES SHOWN FOR REMOVAL MAY BE SAVED IN SOME INSTANCES AND ARE TO BE REVIEWED ON A CASE BY CASE BASIS PRIOR TO ANY REMOVALS TAKING PLACE. NO REMOVALS ALLOWED WITHOUT PRE-AUTHORIZATION BY CITY AND ENGINEER.
2. SUCCESSFUL AIR TEST AND POST CONSTRUCTION VIDEO (INCLUDED IN UNIT PRICE OF SANITARY SEWER) REQUIRED FOR FINAL PROJECT ACCEPTANCE.
3. SEE PLAN SHEET NO. ## FOR PAVEMENT SECTION DETAILS.
4. ALL NON-PAVEMENT RESTORATION TO BE GENERALLY IN-KIND. TURF RESTORATION SHALL BE MADE WITH CLASS A SOD AND TWO (2) INCHES OF TOPSOIL, OR SEED AND MULCH ON THREE (3) INCHES OF TOPSOIL FOR NON IRRIGATED AREAS.
5. SANITARY SEWER TO BE CONSTRUCTED IN ACCORDANCE WITH CITY OF ROCHESTER HILLS STANDARD DETAILS.

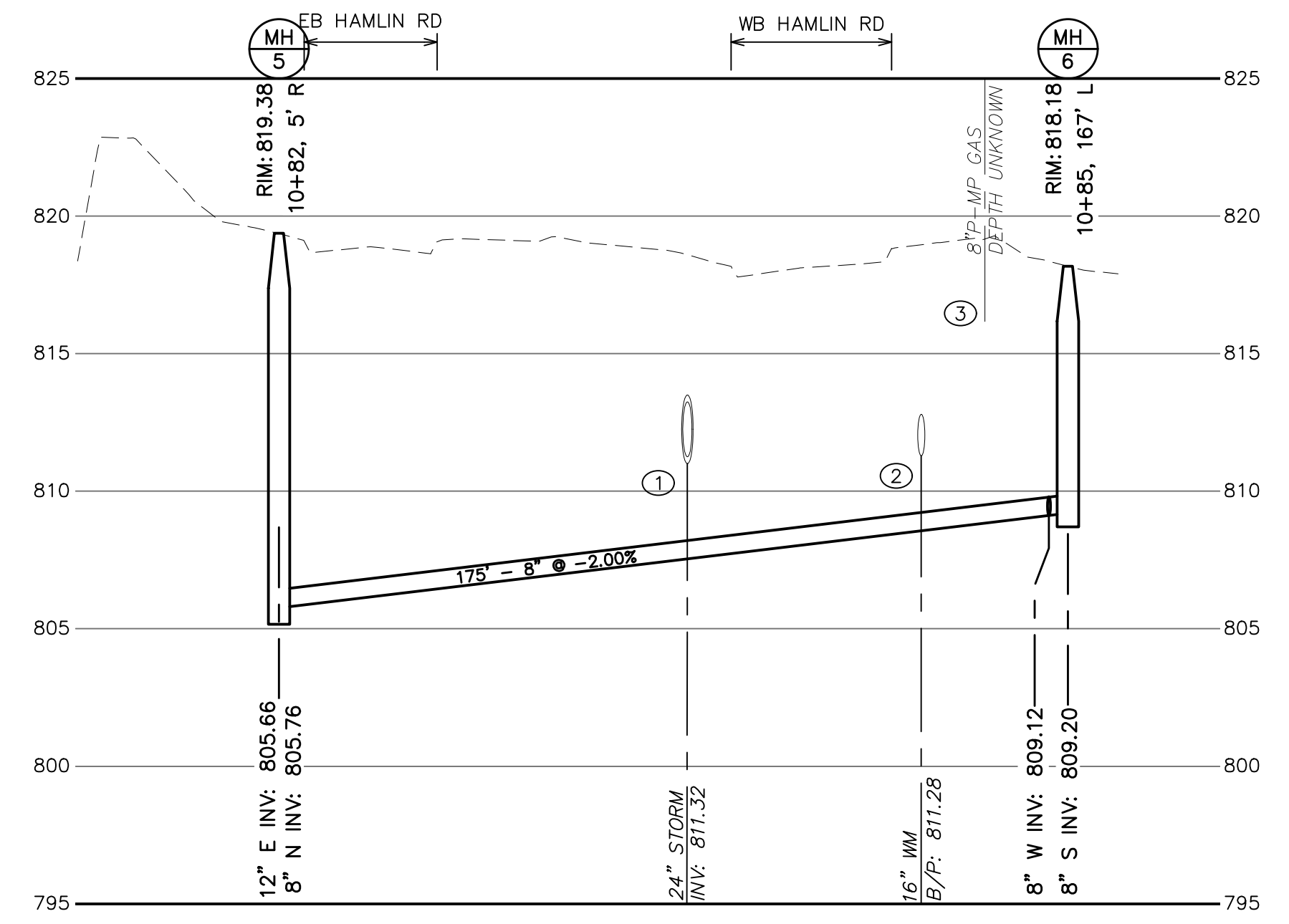

**PROFILE NOTE:**  
 PROFILE OF EXISTING UTILITIES IS DRAWN FROM LIMITED TOPOGRAPHIC SURVEY AND RECORD DRAWINGS (\_\_\_\_). DEPTH OF UTILITIES IS SHOWN FOR ILLUSTRATIVE PURPOSES BASED ON THE BEST INFORMATION AVAILABLE.

**HAMLIN ROAD PROFILE**  
 SCALE: HORIZ. 1"=30'  
 VERT. 1"=5'

UTILITY CROSSING DATA	CLEARANCE	GROUND ELEV.	SAN DEPTH
① EXISTING 24" STM PROPOSED 12" SAN	B/P 811.00' T/P 808.21'	818.60' ±	10.4' ±
② EXISTING 16" WM PROPOSED 12" SAN	B/P 811.28' ± T/P 809.23'	818.96' ±	9.7' ±
③ EXISTING 8" GAS PROPOSED 12" SAN	B/P 815.50' ± T/P 809.50'	819.17' ±	9.7' ±

**NOTICE:**  
 ALL EXISTING UTILITIES SHOWN ON THIS TOPOGRAPHIC SURVEY HAVE BEEN TAKEN FROM VISUAL OBSERVATION AND RECORD MAPPING WHERE AVAILABLE. NO GUARANTEE IS MADE, OR SHOULD BE ASSUMED, AS TO THE COMPLETENESS OR ACCURACY OF THE UTILITIES SHOWN ON THIS DRAWING. PARTIES UTILIZING THIS INFORMATION SHALL FIELD VERIFY.

**811**  
 Know what's below.  
 Call before you dig.  
**CALL811.COM**  
 CALL MISS DIG  
 72 HOURS  
 (3 WORKING DAYS)  
 BEFORE YOU DIG  
 1-800-482-7171  
 or **811**  
 (TOLL FREE)



**HRC**  
**HUBBELL, ROTH & CLARK, INC**  
 CONSULTING ENGINEERS SINCE 1915  
 555 HULET DRIVE P.O. BOX 824  
 BLOOMFIELD HILLS, MICH. 48303-0824  
 PHONE: (248) 454-6300  
 FAX (1st. Floor): (248) 454-6312  
 FAX (2nd. Floor): (248) 454-6359  
 WEB SITE: www.hrcenr.com

DATE	ADDITIONS AND/OR REVISIONS
DESIGNED	RAD
DRAWN	RAD
CHECKED	JJS
APPROVED	JJS



**CITY OF ROCHESTER HILLS**  
**INNOVATION HILLS**  
**RESTROOM SEWER**  
**EXTENSION**

**SANITARY SEWER**

HRC JOB NO.	SCALE
20220926	1" = 30'
DATE	SHEET NO.
February 2024	3 OF

**Attachment B**  
**Soil Gas Sampling Forms**

# Soil Gas Sampling Form

Sample ID: SG-1

Sampler Name: ENM, BLB

Project Number: 13059-1

Date: 5/22/2024

Project Name: Hamlin & Adams

Location: Rochester Hills,  
Michigan

Weather Conditions: cloudy, ~73°F, 29.70 in/Hg Rain Within 24 Hours? NO

Slab Thickness (Inches): \_\_\_\_\_ (for vapor pin installation)

Type of Flooring \_\_\_\_\_ Flooring Recently Installed/Cleaned? \_\_\_\_\_

Soil Gas Screen Depth: 5' bgs (for soil gas well installation)

Tubing Diameter 1/4" Tubing type polyethylene

### Tracer Gas Leak Test

Purge Start Time: 1026 Purge Rate ~200 mL/min

Purge End Time: 1036

Collect after purge before argon injection

Interior argon reading pre-injection 0 In-line argon reading pre-injection 0

Collect after argon injection

Argon injection time 1037

Interior argon reading >0 In-line argon reading 0

In-line argon reading (after 15 minutes or after sampling) 0 0

### Sample Collection Information

% Oxygen 9.5% % CO<sub>2</sub> 9.3%

% Methane 29.0% CO = 8 ppm

Regulator ID: \_\_\_\_\_

Canister ID: \_\_\_\_\_

Pressure Listed on Tab of Sample Container From Lab ("Hg): \_\_\_\_\_

Date of Pressure Test From Lab Listed on Tab of Container: \_\_\_\_\_

Sampling Start Time: \_\_\_\_\_

Initial sample container pressure at start of sampling ("Hg): \_\_\_\_\_

Sampling End Time: \_\_\_\_\_

Final sample container pressure ("Hg): \_\_\_\_\_

Notes: \_\_\_\_\_  
\_\_\_\_\_  
\_\_\_\_\_

# Soil Gas Sampling Form

Sample ID: SG-2

Sampler Name: \_\_\_\_\_ ENM, BLB

Project Number: \_\_\_\_\_ 13059-1

Date: \_\_\_\_\_ 5/22/2024

Project Name: \_\_\_\_\_ Hamlin & Adams

Location: \_\_\_\_\_ Rochester Hills,  
\_\_\_\_\_ Michigan

Weather Conditions: cloudy, ~73°F, 29.70 in/Hg Rain Within 24 Hours? NO

Slab Thickness (Inches): \_\_\_\_\_ (for vapor pin installation) \_\_\_\_\_

Type of Flooring \_\_\_\_\_ Flooring Recently Installed/Cleaned? \_\_\_\_\_

Soil Gas Screen Depth: 5' bgs (for soil gas well installation)

Tubing Diameter 1/4" Tubing type polyethylene

### Tracer Gas Leak Test

Purge Start Time: 1043 Purge Rate ~200 mL/min

Purge End Time: 1053

Collect after purge before argon injection

Interior argon reading pre-injection 0 In-line argon reading pre-injection 0

Collect after argon injection

Argon injection time 1054  
Interior argon reading >0 In-line argon reading 0

In-line argon reading (after 15 minutes or after sampling) 0

### Sample Collection Information

% Oxygen 14.7% % CO<sub>2</sub> 3.5%

% Methane 0%

CO = 0 ppm

Regulator ID: \_\_\_\_\_

Canister ID: \_\_\_\_\_

Pressure Listed on Tab of Sample Container From Lab ("Hg): \_\_\_\_\_

Date of Pressure Test From Lab Listed on Tab of Container \_\_\_\_\_

Sampling Start Time: \_\_\_\_\_

Initial sample container pressure at start of sampling ("Hg): \_\_\_\_\_

Sampling End Time: \_\_\_\_\_

Final sample container pressure ("Hg): \_\_\_\_\_

Notes: \_\_\_\_\_  
\_\_\_\_\_  
\_\_\_\_\_



# Soil Gas Sampling Form

Sample ID: SG-3

Sampler Name: ENM, BLB

Project Number: 13059-1

Date: 5/22/2024

Project Name: Hamlin & Adams

Location: Rochester Hills,  
Michigan

Weather Conditions: cloudy, ~73°F, 29.70 in/Hg Rain Within 24 Hours? NO

Slab Thickness (Inches): \_\_\_\_\_ (for vapor pin installation)

Type of Flooring \_\_\_\_\_ Flooring Recently Installed/Cleaned? \_\_\_\_\_

Soil Gas Screen Depth: 5' bgs (for soil gas well installation)

Tubing Diameter 1/4" Tubing type polyethylene

### Tracer Gas Leak Test

Purge Start Time: 1056 Purge Rate ~200 mL/min

Purge End Time: 1106

### Collect after purge before argon injection

Interior argon reading pre-injection 0 In-line argon reading pre-injection 0

### Collect after argon injection

Argon injection time 1107  
Interior argon reading 70 In-line argon reading 0

In-line argon reading (after 15 minutes or after sampling) 0

### Sample Collection Information

% Oxygen 18.2% % CO<sub>2</sub> 1.7%  
% Methane 0%

CO = 0 ppm

Regulator ID: \_\_\_\_\_

Canister ID: \_\_\_\_\_

Pressure Listed on Tab of Sample Container From Lab ("Hg): \_\_\_\_\_

Date of Pressure Test From Lab Listed on Tab of Container \_\_\_\_\_

Sampling Start Time: \_\_\_\_\_

Initial sample container pressure at start of sampling ("Hg): \_\_\_\_\_

Sampling End Time: \_\_\_\_\_

Final sample container pressure ("Hg): \_\_\_\_\_

Notes: \_\_\_\_\_  
\_\_\_\_\_  
\_\_\_\_\_

# Soil Gas Sampling Form

Sample ID: SG-4

Sampler Name: ENM, BLB

Project Number: 13059-1

Date: 5/22/2024

Project Name: Hamlin & Adams

Location: Rochester Hills,  
Michigan

Weather Conditions: cloudy, ~73°F, 29.70 in/Hg Rain Within 24 Hours? NO

~~Slab Thickness (Inches): \_\_\_\_\_ (for vapor pin installation)~~

~~Type of Flooring \_\_\_\_\_ Flooring Recently Installed/Cleaned? \_\_\_\_\_~~

Soil Gas Screen Depth: 5' bgs (for soil gas well installation)

Tubing Diameter 1/4" Tubing type polyethylene

### Tracer Gas Leak Test

Purge Start Time: 1110 Purge Rate ~200 mL/min

Purge End Time: 1120

### Collect after purge before argon injection

Interior argon reading 0 In-line argon reading 0  
pre-injection pre-injection

### Collect after argon injection

Argon injection time 1121

Interior argon reading 20 In-line argon reading 0

In-line argon reading  
(after 15 minutes or after  
sampling) 0

### Sample Collection Information

% Oxygen 18.7% % CO<sub>2</sub> 0.0%

% Methane 0% CO = 0 ppm

Regulator ID: \_\_\_\_\_

Canister ID: \_\_\_\_\_

Pressure Listed on Tab of Sample Container From Lab ("Hg): \_\_\_\_\_

Date of Pressure Test From Lab Listed on Tab of Container \_\_\_\_\_

Sampling Start Time: \_\_\_\_\_

Initial sample container pressure at start of sampling ("Hg): \_\_\_\_\_

Sampling End Time: \_\_\_\_\_

Final sample container pressure ("Hg): \_\_\_\_\_

Notes: \_\_\_\_\_  
\_\_\_\_\_  
\_\_\_\_\_

**Attachment C**  
**Groundwater Sampling Field Data Sheets**

# GROUNDWATER SAMPLING FIELD DATA SHEET

**SITE LOCATION:** Hamlin Rd and Adams (13059-1), Rochester Hills

Date: 5/23/24

Well Number: SB-3-MW + DUP-1GW

Personnel Present: ENM

Parameters to be Analyzed: VOCs, PNAs, Michigan 10 Metals, PCBs, PFAS, diss. methane

**WELL DATA:**

Well Secure Upon Arrival:  Yes ( ) No    Secure Upon Departure: (x ) Yes ( ) No

Screen Length: 10 ft    Total Depth of Well: 16 ft bgs    Static Water Level: 10.7' bgs

**PURGING DATA:**    Depth to Water (ft):    Depth to Water(w/pump):

Drawdown (ft)    to    Flow Rate (mL/minute): ~100 mL/min

purge  
start  
@ 11:14

Time	pH (sU) (±0.1)	Temp (°C) (±3%)	Cond.(uS) (± 3%)	DO (mg/L) (±10%)	Turb.(NTU) (±10%)	ORP (mV) (±10)	depth of gw Notes (ft) bgs
1119	7.05	9.1	0.93	2.60	60.5	107.6	10.8
1124	7.09	8.9	0.92	3.06	26.3	78.8	10.8
1129	7.11	8.9	0.91	3.38	19.9	54.1	10.8
1134	7.12	8.9	0.90	3.52	15.1	37.6	10.8
1139	7.12	8.8	0.90	3.06	16.3	28.7	10.8
Parameters Stable (Y/N)	Y	Y	Y	Y	Y	Y	Y

Sample Time: 11:45 (+ DUP-1GW)

Weather Conditions: 73°F, sunny, 29.92 inHg

Equipment Used: YSI w/ flow-through cell, peristaltic pump, turbidimeter, water-level meter

Comments And Observations: equipment and sampling materials are all PFAS-free according to EGLE guidance docs

Modified June 26, 2006

Notes: 2in = 617 ml/ft, 4in = 2470 ml/ft: Vol. cyl. = πr²h, Vol. sphere = 4/3π r³

# GROUNDWATER SAMPLING FIELD DATA SHEET

**SITE LOCATION:** Hamlin Rd and Adams (13059-1), Rochester Hills

Date: 5/23/24

Well Number: SB-4-MW

Personnel Present: ENM

Parameters to be Analyzed: VOCs, PNAs, Michigan 10 Metals, PCBs, PFAS, diss. methane

**WELL DATA:**

Well Secure Upon Arrival: (X) Yes ( ) No    Secure Upon Departure: (x ) Yes ( ) No

Screen Length: 10 ft    Total Depth of Well: 12'    Static Water Level: 3.6'

**PURGING DATA:**    Depth to Water (ft):    Depth to Water(w/pump):

Drawdown (ft)    to    Flow Rate (mL/minute): ~100 mL/min

purge start @ 13:00

Time	pH (sU) (±0.1)	Temp (°C) (±3%)	Cond.(uS) (± 3%)	DO (mg/L) (±10%)	Turb.(NTU) (±10%)	ORP (mV) (±10)	depth of gw bgs Notes (ft)
13:05	7.66	15.2	1.63	0.71	45.6	-172.4	3.7
13:10	7.61	15.3	1.61	0.58	23.6	-219.5	3.7
13:15	7.57	15.2	1.59	0.46	13.7	-253.8	3.7
13:20	7.56	15.4	1.59	0.39	11.1	-260.6	3.7
13:25	7.55	15.4	1.59	0.42	9.64	-270.2	3.7
13:30	7.54	15.5	1.59	0.37	10.3	-280.1	3.7
Parameters Stable (Y/N)	Y	Y	Y	Y	Y	Y	Y

Sample Time: 13:38

Weather Conditions: 77°F, sunny, 29.91 inHg

Equipment Used: YSI w/ flow-through cell, peristaltic pump, turbidimeter, water level meter

Comments And Observations: equipment and sampling materials are all PFAS-free according to EGLE guidance docs

Modified June 26, 2006

Notes: 2in = 617 ml/ft, 4in = 2470 ml/ft: Vol. cyl. = πr<sup>2</sup>h, Vol. sphere = 4/3π r<sup>3</sup>

**Attachment D**  
**Soil Boring Logs**



# Boring ID:

**SB-1**

Client: City of Rochester Hills

Project Name: Hamlin and Adams

Project Number: 13059-1

Date Completed: 5/22/2024

Site Address: Hamlin and Adams

Rochester Hills, MI 48216

Driller: ERG

Drilling Method: Direct push drill

ASTI Geologist: ENM

Total Depth: 12 feet bgs

Size: N/A

Type: N/A

Screen Length: N/A

Well Depth: N/A

Depth to GW: 5 feet bgs

Depth (ft.)	Graphic Log	Lithologic Description	PID (ppm)	Sample Depth	% Recovery
0		SANDY SILT: topsoil, little to few organics, brown, loose, fill (silt loam)	0.0		100
1		SANDY SILT: trace organics, brick, brown, loose, fill (silt loam)			
2		SAND: very fine to fine grained, trace gravel, brown, moist, medium dense (sand)	0.0		100
3		SANDY CLAY: gray/brown, soft (sandy clay)			
4		SAND: very fine grained, gray, moist, dense (sand)	0.0	Soil at (4-5')	100
5		SAND: very fine grained, gray, wet, dense (sand)			
6		SILTY CLAY: some very fine grained sand, gray, soft (silty clay)	0.0		100
7		SAND: very fine grained, gray, moist, dense (sand)			
8			0.0		100
9					
10			0.0	Soil at (10-11')	100
11					
12		END OF BORING			

**Comments:**

ppm = parts per million    MW = monitoring well    bgs = below ground surface    ( ) = USDA soil texture

➤ Groundwater Encountered at Depth



# Boring ID:

**SB-2**

Client: City of Rochester Hills

Project Name: Hamlin and Adams

Project Number: 13059-1

Date Completed: 5/22/2024

Site Address: Hamlin and Adams

Rochester Hills, MI 48216

Driller: ERG

Drilling Method: Direct push drill

ASTI Geologist: ENM

Total Depth: 16 feet bgs

Size: N/A

Type: N/A

Screen Length: N/A

Well Depth: N/A

Depth to GW: 11 feet bgs

Depth (ft.)	Graphic Log	Lithologic Description	PID (ppm)	Sample Depth	% Recovery
0		SANDY SILT: topsoil, some organics, brown, medium dense (silt loam)			
1		SILTY very fine to medium SAND: trace gravel, brown, moist, medium dense (silt loam)	0.0		75
2					
3		SILTY CLAY: few to little fine to very coarse grained sand, brown, moist, medium dense (silty clay)	0.0		
4		SAND: very fine to medium grained, brown, moist, loose (sand)			100
5			0.0		
6					
7			0.0		
8					100
9			0.0	Soil at (9-10')	
10				Soil at (10-11')	
11		SAND: very fine to medium grained, brown, wet, loose (sand)	0.0		
12					100
13			0.0		
14					
15			0.0		
16		END OF BORING			

**Comments:**

ppm = parts per million    MW = monitoring well    bgs = below ground surface    ( ) = USDA soil texture

✦ Groundwater Encountered at Depth





# Boring ID:

**SB-3-MW**

**Client:** City of Rochester Hills

**Project Name:** Hamlin and Adams

**Project Number:** 13059-1

**Date Completed:** 5/22/2024

**Site Address:** Hamlin and Adams

Rochester Hills, MI 48216

**Driller:** ERG

**Drilling Method:** Direct push drill

**ASTI Geologist:** ENM

**Total Depth:** 16 feet bgs

**Size:** 2-inch

**Type:** PVC

**Screen Length:** 10 feet

**Well Depth:** 16 feet bgs

**Depth to GW:** 11 feet bgs

Depth (ft.)	Graphic Log	Lithologic Description	PID (ppm)	Sample Depth	% Recovery
0		SANDY SILT: topsoil, few to some organics, brown, medium dense (silt loam)			
1		GRAVELLY very fine to very coarse SAND: brown, moist, loose (sand)	0.0		100
2					
3			0.0		
4					100
5			0.0		
6			0.0		
7		SAND: very fine to medium grained, brown, moist, medium dense (sand)	0.0		100
8					
9			0.0	Soil at (9-10')	
10					100
11			0.0	Soil at (10-11')	
12		SAND: fine to medium grained, brown, wet, loose (sand)			
13					60
14			0.0		
15			0.0		
16		END OF BORING			

**Comments:**

ppm = parts per million    MW = monitoring well    bgs = below ground surface    ( ) = USDA soil texture

✦ Groundwater Encountered at Depth



# Boring ID:

**SB-4-MW**

Client: City of Rochester Hills

Project Name: Hamlin and Adams

Project Number: 13059-1

Date Completed: 5/22/2024

Site Address: Hamlin and Adams

Rochester Hills, MI 48216

Driller: ERG

Drilling Method: Direct push drill

ASTI Geologist: ENM

Total Depth: 12 feet bgs

Size: 2-inch

Type: PVC

Screen Length: 10 feet

Well Depth: 12 feet bgs

Depth to GW: 2.5 feet bgs

Depth (ft.)	Graphic Log	Lithologic Description	PID (ppm)	Sample Depth	% Recovery
0		CONCRETE			
-1		SAND: very fine to very coarse grained, trace gravel, brown, moist, loose (sand)	0.0		
-2				Soil at (1.5-2.5')	75
-3		SAND: very fine to medium grained, brown, wet, loose (sand)	0.0		
-4					
-5			0.0		
-6					100
-7			0.0		
-8					
-9			0.0		
-10					100
-11		SAND: very fine grained, brown, moist, medium dense (sand)	0.0	Soil at (10-11')	
-12		END OF BORING			

**Comments:**

ppm = parts per million    MW = monitoring well    bgs = below ground surface    ( ) = USDA soil texture

➤ Groundwater Encountered at Depth

**Attachment E**

**Laboratory Analytical Reports and Chain-of-Custody Documentation**



# Analytical Laboratory Report

Report ID: S62474.01(01)  
Generated on 06/17/2024

**Report to**

---

Attention: Tom Wackerman  
ASTI Environmental  
10448 Citation Drive  
Suite 100  
Brighton, MI 48116

Phone: 810-599-5463 FAX:  
Email: twacker@asti-env.com

Additional Contacts: Brad Buswell, Emily Manetz

**Report produced by**

---

Merit Laboratories, Inc.  
2680 East Lansing Drive  
East Lansing, MI 48823

Phone: (517) 332-0167 FAX: (517) 332-6333

Contacts for report questions:  
John Lavery (johnlavery@meritlabs.com)  
Barbara Ball (bball@meritlabs.com)

**Report Summary**

---

Lab Sample ID(s): S62474.01-S62474.13  
Project: Hamlin & Adams / 13059-1  
Collected Date(s): 05/22/2024 - 05/23/2024  
Submitted Date/Time: 05/24/2024 09:00  
Sampled by: Emily Manetz  
P.O. #:

**Table of Contents**

---

- Cover Page (Page 1)
- General Report Notes (Page 2)
- Report Narrative (Page 2)
- Laboratory Accreditations (Page 3)
- Qualifier Descriptions (Page 3)
- Glossary of Abbreviations (Page 3)
- Method Summary (Page 4)
- Parameter Summary (Page 5)
- Sample Summary (Page 6)

Maya Murshak  
Technical Director



# Analytical Laboratory Report

## General Report Notes

---

Analytical results relate only to the samples tested, in the condition received by the laboratory.

Methods may be modified for improved performance.

Results reported on a dry weight basis where applicable.

'Not detected' indicates that parameter was not found at a level equal to or greater than the reporting limit (RL).

When MDL results are provided, then 'Not detected' indicates that parameter was not found at a level equal to or greater than the MDL.

40 CFR Part 136 Table II Required Containers, Preservation Techniques and Holding Times for the Clean Water Act specify that samples for acrolein and acrylonitrile, and 2-chloroethylvinyl ether need to be preserved at a pH in the range of 4 to 5 or if not preserved, analyzed within 3 days of sampling.

QA/QC corresponding to this analytical report is a separate document with the same Merit ID reference and is available upon request.

Starred (\*) analytes are not NY NELAP accredited.

Samples are held by the lab for 30 days from the final report date unless a written request to hold longer is provided by the client.

Report shall not be reproduced except in full, without the written approval of Merit Laboratories, Inc.

Limits for drinking water samples, are listed as the MCL Limits (Maximum Contaminant Level Concentrations)

PFAS requirement: Section 9.3.8 of U.S. EPA Method 537.1 states "If the method analyte(s) found in the Field Sample is present in the

FRB at a concentration greater than 1/3 the MRL, then all samples collected with that FRB are invalid and must be recollected and reanalyzed."

Samples submitted without an accompanying FRB may not be acceptable for compliance purposes.

Wisconsin PFAs analysis: MDL = LOD; RL = LOQ. LOD and LOQ are adjusted for dilution.

All accreditations/certifications held by this laboratory are listed on page 3. Not all accreditations/certifications are applicable to this report.

For a specific list of accredited analytes, please feel free to contact the laboratory or visit <https://www.meritlabs.com/certifications>.

## Report Narrative

---

There is no additional narrative for this analytical report



# Analytical Laboratory Report

## Laboratory Accreditations (For Reference Only)

Authority	Accreditation ID
Michigan DEQ	#9956
DOD ELAP & ISO/IEC 17025:2017	#69699 PJLA Testing
WBENC	#2005110032
Ohio VAP	#CL0002
Indiana DOH	#C-MI-07
New York NELAC	#11814
North Carolina DENR	#680
North Carolina DOH	#26702
Pennsylvania DEP	#68-05884
Wisconsin DNR	FID# 399147320

## Qualifier Descriptions

Qualifier	Description
!	Result is outside of stated limit criteria
B	Compound also found in associated method blank
E	Concentration exceeds calibration range
F	Analysis run outside of holding time
G	Estimated result due to extraction run outside of holding time
H	Sample submitted and run outside of holding time
I	Matrix interference with internal standard
J	Estimated value less than reporting limit, but greater than MDL
L	Elevated reporting limit due to low sample amount
M	Result reported to MDL not RDL
O	Analysis performed by outside laboratory. See attached report.
R	Preliminary result
S	Surrogate recovery outside of control limits
T	No correction for total solids
X	Elevated reporting limit due to matrix interference
Y	Elevated reporting limit due to high target concentration
b	Value detected less than reporting limit, but greater than MDL
e	Reported value estimated due to interference
j	Analyte also found in associated method blank
o	Associated EIS outside of control limits
p	Benzo(b)Fluoranthene and Benzo(k)Fluoranthene integrated as one peak.
q	Qualifier ion ratio outside of control limits
x	Preserved from bulk sample

## Glossary of Abbreviations

Abbreviation	Description
RL/RDL	Reporting Limit
MDL	Method Detection Limit
MS	Matrix Spike
MSD	Matrix Spike Duplicate
SW	EPA SW 846 (Soil and Wastewater) Methods
E	EPA Methods
SM	Standard Methods
LN	Linear
BR	Branched



# Analytical Laboratory Report

## Method Summary

Method	Version
ASTM D7968-17M	ASTM Method D7968 - 17 Modified (Isotopic Dilution)
ASTMD7979-19M	ASTM Method D7979 - 19 Modified (Isotopic Dilution)
E200.8	EPA Method 200.8 Revision 5.4
E245.1	EPA Method 245.1 Revision 3.0
E608.3	EPA Method 608.3 December 2016
N/A	Not Applicable
RSK-175	RSK-175
SM2540B	Standard Method 2540 B 2015
SW3015A	SW 846 Method 3015A Revision 1 February 2007
SW3050B	SW 846 Method 3050B Revision 2 December 1996
SW3510C	SW 846 Method 3510C Revision 3 December 1996
SW3546	SW 846 Method 3546 Revision 0 February 2007
SW5030C/8260C	SW 846 Method 8260C Revision 3 August 2006 / 5030C Revision 3 May 2003
SW5035A	SW 846 Method 5035A Revision 1 July 2002
SW5035A/8260C	SW 846 Method 8260C Revision 3 August 2006 / 5035A Revision 1 July 2002
SW6020A	SW 846 Method 6020A Revision 1 February 2007
SW7471B	SW 846 Method 7471B Revision 2 February 2007
SW8082A	SW 846 Method 8082A Revision 1 February 2007
SW8270D	SW 846 Method 8270D Revision 4 February 2007

## Parameter Summary

Parameter	Synonym	Cas #
PFBA	Perfluorobutanoic Acid	375-22-4
PFPeA	Perfluoropentanoic Acid	2706-90-3
4:2 FTSA	4:2 Fluorotelomer Sulfonic Acid	757124-72-4
PFHxA	Perfluorohexanoic Acid	307-24-4
PFBS	Perfluorobutane sulfonic Acid	375-73-5
PFHpA	Perfluoroheptanoic Acid	375-85-9
PFPeS	Perfluoropentane Sulfonic Acid	2706-91-4
6:2 FTSA	6:2 Fluorotelomer Sulfonic Acid	27619-97-2
PFOA	Perfluorooctanoic Acid	335-67-1
PFHxS	Perfluorohexane Sulfonic Acid	355-46-4
PFHxS-LN	Perfluorohexane Sulfonic Acid - LN	355-46-4-LN
PFHxS-BR	Perfluorohexane Sulfonic Acid - BR	355-46-4-BR
PFNA	Perfluorononanoic Acid	375-95-1
8:2 FTSA	8:2 Fluorotelomer Sulfonic Acid	39108-34-4
PFHpS	Perfluoroheptane Sulfonic Acid	375-92-8
PFDA	Perfluorodecanoic Acid	335-76-2
N-MeFOSAA	N-methyl perfluorooctanesulfonamidoacetic acid	2355-31-9
EtFOSAA	N-Ethyl Perfluorooctane Sulfonamidoacetic Acid	2991-50-6
PFOS	Perfluorooctane Sulfonic Acid	1763-23-1
PFOS-LN	Perfluorooctane Sulfonic Acid - LN	1763-23-1-LN
PFOS-BR	Perfluorooctane Sulfonic Acid - BR	1763-23-1-BR
PFUnDA	Perfluoroundecanoic Acid	2058-94-8
PFNS	Perfluorononane Sulfonic Acid	68259-12-1
PFDoDA	Perfluorododecanoic Acid	307-55-1
PFDS	Perfluorodecane Sulfonic Acid	335-77-3
PFTTrDA	Perfluorotridecanoic Acid	72629-94-8
FOSA	Perfluorooctane Sulfonamide	754-91-6
PFTeDA	Perfluorotetradecanoic Acid	376-06-7
11Cl-PF3OUdS	11-chloroeicosafuoro-3-oxaundecane-1-sulfonic acid	763051-92-9
9Cl-PF3ONS	9-chlorohexadecafluoro-3-oxanone1-sulfonic acid	756426-58-1
ADONA	4,8-dioxa-3H-perfluorononanoic acid	919005-14-4
HFPO-DA	Hexafluoropropylene oxide dimer	13252-13-6





# Analytical Laboratory Report

## Sample Summary (13 samples)

Sample ID	Sample Tag	Matrix	Collected Date/Time
S62474.01	SB-1 (4-5')	Soil	05/22/24 16:00
S62474.02	SB-1 (10-11')	Soil	05/22/24 16:05
S62474.03	SB-2 (9-10')	Soil	05/22/24 15:15
S62474.04	SB-2 (10-11')	Soil	05/22/24 15:20
S62474.05	SB-3 (9-10')	Soil	05/22/24 14:15
S62474.06	SB-3 (10-11')	Soil	05/22/24 14:20
S62474.07	SB-4 (1.5-2.5')	Soil	05/22/24 13:00
S62474.08	SB-4 (10-11')	Soil	05/22/24 13:05
S62474.09	DUP-1S	Soil	05/22/24 00:01
S62474.10	Meth Blank	Methanol	05/22/24 00:01
S62474.11	SB-3-MW	Groundwater	05/23/24 11:45
S62474.12	SB-4-MW	Groundwater	05/23/24 13:38
S62474.13	DUP-1GW	Groundwater	05/23/24 00:01



# Analytical Laboratory Report

Lab Sample ID: S62474.01

Sample Tag: SB-1 (4-5')

Collected Date/Time: 05/22/2024 16:00

Matrix: Soil

COC Reference: 171234

### Sample Containers

#	Type	Preservative(s)	Refrigerated?	Arrival Temp. (C)	Thermometer #
1	4oz Glass	None	Yes	6.0	IR
1	125mL Plastic	None	Yes	6.0	IR
1	40mL Glass	MeOH	Yes	6.0	IR
1	15mL Centrifuge Tube	None	Yes	6.0	IR

### Extraction / Prep.

Parameter	Result	Method	Run Date	Analyst	Flags
Initial wt. (g) / Final wt. (g) / Volume (ml)*	8.80/6.56/10	ASTM D7968-17M	05/29/24 10:00	SRP	
Metal Digestion	Completed	SW3050B	05/31/24 09:30	JRH	
Extraction, PCB*	Completed	SW3546	05/28/24 12:30	DJS	
PNA Extraction*	Completed	SW3546	05/30/24 15:00	DJS	
Sample wt. (g) / Methanol (ml)*	11.445/11	SW5035A	05/24/24 11:38	NDK	
Mercury Digestion	Completed	SW7471B	05/24/24 11:58	CTV	

### Inorganics

Method: SM2540B, Run Date: 05/28/24 12:48, Analyst: MAM

Parameter	Result	RL	MDL	Units	Dilution	CAS#	Flags
Total Solids*	84	1		%	1		

### Metals

Method: SW6020A, Run Date: 05/31/24 12:24, Analyst: JRH

Parameter	Result	RL	MDL	Units	Dilution	CAS#	Flags
Arsenic	8.82	0.20		mg/kg	252	7440-38-2	
Barium	56.4	1.0		mg/kg	252	7440-39-3	
Cadmium	0.36	0.20		mg/kg	252	7440-43-9	
Chromium	17.3	0.50		mg/kg	252	7440-47-3	
Copper	19.5	0.50		mg/kg	252	7440-50-8	
Lead	8.15	0.30		mg/kg	252	7439-92-1	
Selenium	Not detected	0.40		mg/kg	252	7782-49-2	
Silver	Not detected	0.20		mg/kg	252	7440-22-4	
Zinc	56.5	0.50		mg/kg	252	7440-66-6	

Method: SW7471B, Run Date: 05/24/24 15:07, Analyst: CTV

Parameter	Result	RL	MDL	Units	Dilution	CAS#	Flags
Mercury	Not detected	0.050		mg/kg	72	7439-97-6	

### Organics - PCBs/Pesticides

PCB List, Method: SW8082A, Run Date: 05/29/24 14:12, Analyst: JANB

Parameter	Result	RL	MDL	Units	Dilution	CAS#	Flags
PCB-1016	Not detected	330		ug/kg	5	12674-11-2	
PCB-1242	Not detected	330		ug/kg	5	53469-21-9	
PCB-1221	Not detected	330		ug/kg	5	11104-28-2	
PCB-1232	Not detected	330		ug/kg	5	11141-16-5	
PCB-1248	Not detected	330		ug/kg	5	12672-29-6	
PCB-1254	Not detected	330		ug/kg	5	11097-69-1	
PCB-1260	Not detected	330		ug/kg	5	11096-82-5	



# Analytical Laboratory Report

Lab Sample ID: S62474.01 (continued)

Sample Tag: SB-1 (4-5')

## Organics - Semi-Volatiles

Polynuclear Aromatics, Method: SW8270D, Run Date: 05/31/24 17:35, Analyst: PL

Parameter	Result	RL	MDL	Units	Dilution	CAS#	Flags
Acenaphthene	Not detected	300		ug/kg	10	83-32-9	
Acenaphthylene	Not detected	300		ug/kg	10	208-96-8	
Anthracene	Not detected	300		ug/kg	10	120-12-7	
Benzo(a)anthracene	Not detected	300		ug/kg	10	56-55-3	
Benzo(a)pyrene	Not detected	300		ug/kg	10	50-32-8	
Benzo(b)fluoranthene	Not detected	300		ug/kg	10	205-99-2	
Benzo(k)fluoranthene	Not detected	300		ug/kg	10	207-08-9	
Benzo(ghi)perylene	Not detected	300		ug/kg	10	191-24-2	
Chrysene	Not detected	300		ug/kg	10	218-01-9	
Dibenzo(ah)anthracene	Not detected	300		ug/kg	10	53-70-3	
Fluoranthene	Not detected	300		ug/kg	10	206-44-0	
Fluorene	Not detected	300		ug/kg	10	86-73-7	
Indeno(1,2,3-cd)pyrene	Not detected	300		ug/kg	10	193-39-5	
Naphthalene	Not detected	300		ug/kg	10	91-20-3	
Phenanthrene	Not detected	300		ug/kg	10	85-01-8	
Pyrene	Not detected	300		ug/kg	10	129-00-0	
2-Methylnaphthalene	Not detected	300		ug/kg	10	91-57-6	
1-Methylnaphthalene	Not detected	300		ug/kg	10	90-12-0	

## Organics

28 PFAs, Method: ASTM D7968-17M, Run Date: 05/29/24 16:08, Analyst: KCV

Parameter	Result	RL	MDL	Units	Dilution	CAS#	Flags
PFBA*	Not detected	110		ng/kg	5.31	375-22-4	
PFPeA*	Not detected	53		ng/kg	5.31	2706-90-3	
4:2 FTSA*	Not detected	53		ng/kg	5.31	757124-72-4	
PFHxA*	Not detected	53		ng/kg	5.31	307-24-4	
PFBS*	Not detected	53		ng/kg	5.31	375-73-5	
PFHpA*	Not detected	53		ng/kg	5.31	375-85-9	
PFPeS*	Not detected	53		ng/kg	5.31	2706-91-4	
6:2 FTSA*	Not detected	53		ng/kg	5.31	27619-97-2	
PFOA*	Not detected	53		ng/kg	5.31	335-67-1	
PFHxS*	Not detected	53		ng/kg	5.31	355-46-4	
PFHxS-LN*	Not detected	53		ng/kg	5.31	355-46-4-LN	
PFHxS-BR*	Not detected	53		ng/kg	5.31	355-46-4-BR	
PFNA*	Not detected	53		ng/kg	5.31	375-95-1	
8:2 FTSA*	Not detected	53		ng/kg	5.31	39108-34-4	
PFHpS*	Not detected	53		ng/kg	5.31	375-92-8	
PFDA*	Not detected	53		ng/kg	5.31	335-76-2	
N-MeFOSAA*	Not detected	53		ng/kg	5.31	2355-31-9	
EtFOSAA*	Not detected	53		ng/kg	5.31	2991-50-6	
PFOS*	Not detected	53		ng/kg	5.31	1763-23-1	
PFOS-LN*	Not detected	53		ng/kg	5.31	1763-23-1-LN	
PFOS-BR*	Not detected	53		ng/kg	5.31	1763-23-1-BR	
PFUnDA*	Not detected	53		ng/kg	5.31	2058-94-8	
PFNS*	Not detected	53		ng/kg	5.31	68259-12-1	
PFDODA*	Not detected	53		ng/kg	5.31	307-55-1	
PFDS*	Not detected	53		ng/kg	5.31	335-77-3	
PFTTrDA*	Not detected	53		ng/kg	5.31	72629-94-8	
FOSA*	Not detected	53		ng/kg	5.31	754-91-6	



# Analytical Laboratory Report

Lab Sample ID: S62474.01 (continued)

Sample Tag: SB-1 (4-5')

## 28 PFAs, Method: ASTM D7968-17M, Run Date: 05/29/24 16:08, Analyst: KCV (continued)

Parameter	Result	RL	MDL	Units	Dilution	CAS#	Flags
PFTeDA*	Not detected	53		ng/kg	5.31	376-06-7	
11Cl-PF3OUdS*	Not detected	53		ng/kg	5.31	763051-92-9	
9Cl-PF3ONS*	Not detected	53		ng/kg	5.31	756426-58-1	
ADONA*	Not detected	53		ng/kg	5.31	919005-14-4	
HFPO-DA*	Not detected	53		ng/kg	5.31	13252-13-6	

## Volatile Organics 5035, Method: SW5035A/8260C, Run Date: 05/25/24 15:04, Analyst: KAG

Parameter	Result	RL	MDL	Units	Dilution	CAS#	Flags
Diethyl ether	Not detected	300		ug/kg	66.7	60-29-7	
Acetone	Not detected	1,000		ug/kg	66.7	67-64-1	
Methyl iodide	Not detected	100		ug/kg	66.7	74-88-4	
Carbon disulfide	Not detected	300		ug/kg	66.7	75-15-0	
tert-Methyl butyl ether (MTBE)	Not detected	300		ug/kg	66.7	1634-04-4	
Acrylonitrile	Not detected	100		ug/kg	66.7	107-13-1	
2-Butanone (MEK)	Not detected	1,000		ug/kg	66.7	78-93-3	
Dichlorodifluoromethane	Not detected	300		ug/kg	66.7	75-71-8	
Chloromethane	Not detected	300		ug/kg	66.7	74-87-3	
Vinyl chloride	Not detected	70		ug/kg	66.7	75-01-4	
Bromomethane	Not detected	300		ug/kg	66.7	74-83-9	
Chloroethane	Not detected	300		ug/kg	66.7	75-00-3	
Trichlorofluoromethane	Not detected	100		ug/kg	66.7	75-69-4	
1,1-Dichloroethene	Not detected	70		ug/kg	66.7	75-35-4	
Methylene chloride	Not detected	100		ug/kg	66.7	75-09-2	
trans-1,2-Dichloroethene	Not detected	70		ug/kg	66.7	156-60-5	
1,1-Dichloroethane	Not detected	70		ug/kg	66.7	75-34-3	
cis-1,2-Dichloroethene	Not detected	70		ug/kg	66.7	156-59-2	
Tetrahydrofuran*	Not detected	1,000		ug/kg	66.7	109-99-9	
Chloroform	Not detected	70		ug/kg	66.7	67-66-3	
Bromochloromethane	Not detected	100		ug/kg	66.7	74-97-5	
1,1,1-Trichloroethane	Not detected	70		ug/kg	66.7	71-55-6	
4-Methyl-2-pentanone (MIBK)	Not detected	3,000		ug/kg	66.7	108-10-1	
2-Hexanone	Not detected	3,000		ug/kg	66.7	591-78-6	
Carbon tetrachloride	Not detected	70		ug/kg	66.7	56-23-5	
Benzene	Not detected	70		ug/kg	66.7	71-43-2	
1,2-Dichloroethane	Not detected	70		ug/kg	66.7	107-06-2	
Trichloroethene	Not detected	70		ug/kg	66.7	79-01-6	
1,2-Dichloropropane	Not detected	70		ug/kg	66.7	78-87-5	
Bromodichloromethane	Not detected	100		ug/kg	66.7	75-27-4	
Dibromomethane	Not detected	300		ug/kg	66.7	74-95-3	
cis-1,3-Dichloropropene	Not detected	70		ug/kg	66.7	10061-01-5	
Toluene	Not detected	70		ug/kg	66.7	108-88-3	
trans-1,3-Dichloropropene	Not detected	70		ug/kg	66.7	10061-02-6	
1,1,2-Trichloroethane	Not detected	70		ug/kg	66.7	79-00-5	
Tetrachloroethene	Not detected	70		ug/kg	66.7	127-18-4	
trans-1,4-Dichloro-2-butene	Not detected	70		ug/kg	66.7	110-57-6	
Dibromochloromethane	Not detected	100		ug/kg	66.7	124-48-1	
1,2-Dibromoethane	Not detected	30		ug/kg	66.7	106-93-4	M
Chlorobenzene	Not detected	70		ug/kg	66.7	108-90-7	
1,1,1,2-Tetrachloroethane	Not detected	100		ug/kg	66.7	630-20-6	

M-Result reported to MDL not RDL



# Analytical Laboratory Report

Lab Sample ID: S62474.01 (continued)

Sample Tag: SB-1 (4-5')

**Volatile Organics 5035, Method: SW5035A/8260C, Run Date: 05/25/24 15:04, Analyst: KAG (continued)**

Parameter	Result	RL	MDL	Units	Dilution	CAS#	Flags
Ethylbenzene	Not detected	70		ug/kg	66.7	100-41-4	
p,m-Xylene	Not detected	100		ug/kg	66.7		
o-Xylene	Not detected	70		ug/kg	66.7	95-47-6	
Styrene	Not detected	70		ug/kg	66.7	100-42-5	
Isopropylbenzene	Not detected	300		ug/kg	66.7	98-82-8	
Bromoform	Not detected	100		ug/kg	66.7	75-25-2	
1,1,2,2-Tetrachloroethane	Not detected	70		ug/kg	66.7	79-34-5	
1,2,3-Trichloropropane	Not detected	100		ug/kg	66.7	96-18-4	
n-Propylbenzene	Not detected	70		ug/kg	66.7	103-65-1	
Bromobenzene	Not detected	100		ug/kg	66.7	108-86-1	
1,3,5-Trimethylbenzene	Not detected	70		ug/kg	66.7	108-67-8	
tert-Butylbenzene	Not detected	70		ug/kg	66.7	98-06-6	
1,2,4-Trimethylbenzene	Not detected	70		ug/kg	66.7	95-63-6	
sec-Butylbenzene	Not detected	70		ug/kg	66.7	135-98-8	
p-Isopropyltoluene	Not detected	100		ug/kg	66.7	99-87-6	
1,3-Dichlorobenzene	Not detected	100		ug/kg	66.7	541-73-1	
1,4-Dichlorobenzene	Not detected	100		ug/kg	66.7	106-46-7	
1,2-Dichlorobenzene	Not detected	100		ug/kg	66.7	95-50-1	
1,2,3-Trimethylbenzene	Not detected	70		ug/kg	66.7	526-73-8	
n-Butylbenzene	Not detected	70		ug/kg	66.7	104-51-8	
Hexachloroethane	Not detected	400		ug/kg	66.7	67-72-1	
1,2-Dibromo-3-chloropropane	Not detected	300		ug/kg	66.7	96-12-8	
1,2,4-Trichlorobenzene	Not detected	440		ug/kg	66.7	120-82-1	
1,2,3-Trichlorobenzene	Not detected	440		ug/kg	66.7	87-61-6	
Naphthalene	Not detected	300		ug/kg	66.7	91-20-3	
2-Methylnaphthalene	Not detected	100		ug/kg	66.7	91-57-6	



# Analytical Laboratory Report

Lab Sample ID: S62474.02

Sample Tag: SB-1 (10-11')

Collected Date/Time: 05/22/2024 16:05

Matrix: Soil

COC Reference: 171234

### Sample Containers

#	Type	Preservative(s)	Refrigerated?	Arrival Temp. (C)	Thermometer #
1	4oz Glass	None	Yes	6.0	IR
1	125mL Plastic	None	Yes	6.0	IR
1	40mL Glass	MeOH	Yes	6.0	IR
1	15mL Centrifuge Tube	None	Yes	6.0	IR

### Extraction / Prep.

Parameter	Result	Method	Run Date	Analyst	Flags
Initial wt. (g) / Final wt. (g) / Volume (ml)*	7.75/6.44/10	ASTM D7968-17M	05/29/24 10:00	SRP	
Metal Digestion	Completed	SW3050B	05/31/24 09:30	JRH	
Extraction, PCB*	Completed	SW3546	05/28/24 12:30	DJS	
PNA Extraction*	Completed	SW3546	05/30/24 15:00	DJS	
Sample wt. (g) / Methanol (ml)*	11.167/11	SW5035A	05/24/24 11:38	NDK	
Mercury Digestion	Completed	SW7471B	05/24/24 11:58	CTV	

### Inorganics

Method: SM2540B, Run Date: 05/28/24 12:48, Analyst: MAM

Parameter	Result	RL	MDL	Units	Dilution	CAS#	Flags
Total Solids*	86	1		%	1		

### Metals

Method: SW6020A, Run Date: 05/31/24 12:27, Analyst: JRH

Parameter	Result	RL	MDL	Units	Dilution	CAS#	Flags
Arsenic	3.80	0.20		mg/kg	247	7440-38-2	
Barium	10.0	1.0		mg/kg	247	7440-39-3	
Cadmium	Not detected	0.20		mg/kg	247	7440-43-9	
Chromium	4.66	0.50		mg/kg	247	7440-47-3	
Copper	6.80	0.50		mg/kg	247	7440-50-8	
Lead	3.11	0.30		mg/kg	247	7439-92-1	
Selenium	Not detected	0.40		mg/kg	247	7782-49-2	
Silver	Not detected	0.20		mg/kg	247	7440-22-4	
Zinc	22.2	0.50		mg/kg	247	7440-66-6	

Method: SW7471B, Run Date: 05/24/24 15:10, Analyst: CTV

Parameter	Result	RL	MDL	Units	Dilution	CAS#	Flags
Mercury	Not detected	0.050		mg/kg	71	7439-97-6	

### Organics - PCBs/Pesticides

PCB List, Method: SW8082A, Run Date: 05/29/24 10:30, Analyst: JANB

Parameter	Result	RL	MDL	Units	Dilution	CAS#	Flags
PCB-1016	Not detected	330		ug/kg	1	12674-11-2	
PCB-1242	Not detected	330		ug/kg	1	53469-21-9	
PCB-1221	Not detected	330		ug/kg	1	11104-28-2	
PCB-1232	Not detected	330		ug/kg	1	11141-16-5	
PCB-1248	Not detected	330		ug/kg	1	12672-29-6	
PCB-1254	Not detected	330		ug/kg	1	11097-69-1	
PCB-1260	Not detected	330		ug/kg	1	11096-82-5	



# Analytical Laboratory Report

Lab Sample ID: S62474.02 (continued)

Sample Tag: SB-1 (10-11')

## Organics - Semi-Volatiles

Polynuclear Aromatics, Method: SW8270D, Run Date: 05/31/24 17:52, Analyst: PL

Parameter	Result	RL	MDL	Units	Dilution	CAS#	Flags
Acenaphthene	Not detected	300		ug/kg	10	83-32-9	
Acenaphthylene	Not detected	300		ug/kg	10	208-96-8	
Anthracene	Not detected	300		ug/kg	10	120-12-7	
Benzo(a)anthracene	Not detected	300		ug/kg	10	56-55-3	
Benzo(a)pyrene	Not detected	300		ug/kg	10	50-32-8	
Benzo(b)fluoranthene	Not detected	300		ug/kg	10	205-99-2	
Benzo(k)fluoranthene	Not detected	300		ug/kg	10	207-08-9	
Benzo(ghi)perylene	Not detected	300		ug/kg	10	191-24-2	
Chrysene	Not detected	300		ug/kg	10	218-01-9	
Dibenzo(ah)anthracene	Not detected	300		ug/kg	10	53-70-3	
Fluoranthene	Not detected	300		ug/kg	10	206-44-0	
Fluorene	Not detected	300		ug/kg	10	86-73-7	
Indeno(1,2,3-cd)pyrene	Not detected	300		ug/kg	10	193-39-5	
Naphthalene	Not detected	300		ug/kg	10	91-20-3	
Phenanthrene	Not detected	300		ug/kg	10	85-01-8	
Pyrene	Not detected	300		ug/kg	10	129-00-0	
2-Methylnaphthalene	Not detected	300		ug/kg	10	91-57-6	
1-Methylnaphthalene	Not detected	300		ug/kg	10	90-12-0	

## Organics

28 PFAs, Method: ASTM D7968-17M, Run Date: 05/29/24 16:48, Analyst: KCV

Parameter	Result	RL	MDL	Units	Dilution	CAS#	Flags
PFBA*	Not detected	180		ng/kg	8.88	375-22-4	
PFPeA*	Not detected	89		ng/kg	8.88	2706-90-3	
4:2 FTSA*	Not detected	89		ng/kg	8.88	757124-72-4	
PFHxA*	Not detected	89		ng/kg	8.88	307-24-4	
PFBS*	Not detected	89		ng/kg	8.88	375-73-5	
PFHpA*	Not detected	89		ng/kg	8.88	375-85-9	
PFPeS*	Not detected	89		ng/kg	8.88	2706-91-4	
6:2 FTSA*	Not detected	89		ng/kg	8.88	27619-97-2	
PFOA*	Not detected	89		ng/kg	8.88	335-67-1	
PFHxS*	Not detected	89		ng/kg	8.88	355-46-4	
PFHxS-LN*	Not detected	89		ng/kg	8.88	355-46-4-LN	
PFHxS-BR*	Not detected	89		ng/kg	8.88	355-46-4-BR	
PFNA*	Not detected	89		ng/kg	8.88	375-95-1	
8:2 FTSA*	Not detected	89		ng/kg	8.88	39108-34-4	
PFHpS*	Not detected	89		ng/kg	8.88	375-92-8	
PFDA*	Not detected	89		ng/kg	8.88	335-76-2	
N-MeFOSAA*	Not detected	89		ng/kg	8.88	2355-31-9	
EtFOSAA*	Not detected	89		ng/kg	8.88	2991-50-6	
PFOS*	Not detected	89		ng/kg	8.88	1763-23-1	
PFOS-LN*	Not detected	89		ng/kg	8.88	1763-23-1-LN	
PFOS-BR*	Not detected	89		ng/kg	8.88	1763-23-1-BR	
PFUnDA*	Not detected	89		ng/kg	8.88	2058-94-8	
PFNS*	Not detected	89		ng/kg	8.88	68259-12-1	
PFDODA*	Not detected	89		ng/kg	8.88	307-55-1	
PFDS*	Not detected	89		ng/kg	8.88	335-77-3	
PFTTrDA*	Not detected	89		ng/kg	8.88	72629-94-8	
FOSA*	Not detected	89		ng/kg	8.88	754-91-6	



# Analytical Laboratory Report

Lab Sample ID: S62474.02 (continued)

Sample Tag: SB-1 (10-11')

**28 PFAs, Method: ASTM D7968-17M, Run Date: 05/29/24 16:48, Analyst: KCV (continued)**

Parameter	Result	RL	MDL	Units	Dilution	CAS#	Flags
PFTeDA*	Not detected	89		ng/kg	8.88	376-06-7	
11Cl-PF3OUdS*	Not detected	89		ng/kg	8.88	763051-92-9	
9Cl-PF3ONS*	Not detected	89		ng/kg	8.88	756426-58-1	
ADONA*	Not detected	89		ng/kg	8.88	919005-14-4	
HFPO-DA*	Not detected	89		ng/kg	8.88	13252-13-6	

**Volatile Organics 5035, Method: SW5035A/8260C, Run Date: 05/25/24 15:27, Analyst: KAG**

Parameter	Result	RL	MDL	Units	Dilution	CAS#	Flags
Diethyl ether	Not detected	300		ug/kg	65.4	60-29-7	
Acetone	Not detected	1,000		ug/kg	65.4	67-64-1	
Methyl iodide	Not detected	100		ug/kg	65.4	74-88-4	
Carbon disulfide	Not detected	300		ug/kg	65.4	75-15-0	
tert-Methyl butyl ether (MTBE)	Not detected	300		ug/kg	65.4	1634-04-4	
Acrylonitrile	Not detected	100		ug/kg	65.4	107-13-1	
2-Butanone (MEK)	Not detected	980		ug/kg	65.4	78-93-3	
Dichlorodifluoromethane	Not detected	300		ug/kg	65.4	75-71-8	
Chloromethane	Not detected	300		ug/kg	65.4	74-87-3	
Vinyl chloride	Not detected	70		ug/kg	65.4	75-01-4	
Bromomethane	Not detected	300		ug/kg	65.4	74-83-9	
Chloroethane	Not detected	300		ug/kg	65.4	75-00-3	
Trichlorofluoromethane	Not detected	100		ug/kg	65.4	75-69-4	
1,1-Dichloroethene	Not detected	70		ug/kg	65.4	75-35-4	
Methylene chloride	Not detected	100		ug/kg	65.4	75-09-2	
trans-1,2-Dichloroethene	Not detected	70		ug/kg	65.4	156-60-5	
1,1-Dichloroethane	Not detected	70		ug/kg	65.4	75-34-3	
cis-1,2-Dichloroethene	Not detected	70		ug/kg	65.4	156-59-2	
Tetrahydrofuran*	Not detected	1,000		ug/kg	65.4	109-99-9	
Chloroform	Not detected	70		ug/kg	65.4	67-66-3	
Bromochloromethane	Not detected	100		ug/kg	65.4	74-97-5	
1,1,1-Trichloroethane	Not detected	70		ug/kg	65.4	71-55-6	
4-Methyl-2-pentanone (MIBK)	Not detected	3,000		ug/kg	65.4	108-10-1	
2-Hexanone	Not detected	3,000		ug/kg	65.4	591-78-6	
Carbon tetrachloride	Not detected	70		ug/kg	65.4	56-23-5	
Benzene	Not detected	70		ug/kg	65.4	71-43-2	
1,2-Dichloroethane	Not detected	70		ug/kg	65.4	107-06-2	
Trichloroethene	Not detected	70		ug/kg	65.4	79-01-6	
1,2-Dichloropropane	Not detected	70		ug/kg	65.4	78-87-5	
Bromodichloromethane	Not detected	100		ug/kg	65.4	75-27-4	
Dibromomethane	Not detected	300		ug/kg	65.4	74-95-3	
cis-1,3-Dichloropropene	Not detected	70		ug/kg	65.4	10061-01-5	
Toluene	Not detected	70		ug/kg	65.4	108-88-3	
trans-1,3-Dichloropropene	Not detected	70		ug/kg	65.4	10061-02-6	
1,1,2-Trichloroethane	Not detected	70		ug/kg	65.4	79-00-5	
Tetrachloroethene	Not detected	70		ug/kg	65.4	127-18-4	
trans-1,4-Dichloro-2-butene	Not detected	70		ug/kg	65.4	110-57-6	
Dibromochloromethane	Not detected	100		ug/kg	65.4	124-48-1	
1,2-Dibromoethane	Not detected	30		ug/kg	65.4	106-93-4	M
Chlorobenzene	Not detected	70		ug/kg	65.4	108-90-7	
1,1,1,2-Tetrachloroethane	Not detected	100		ug/kg	65.4	630-20-6	

M-Result reported to MDL not RDL





# Analytical Laboratory Report

Lab Sample ID: S62474.02 (continued)

Sample Tag: SB-1 (10-11')

**Volatile Organics 5035, Method: SW5035A/8260C, Run Date: 05/25/24 15:27, Analyst: KAG (continued)**

Parameter	Result	RL	MDL	Units	Dilution	CAS#	Flags
Ethylbenzene	Not detected	70		ug/kg	65.4	100-41-4	
p,m-Xylene	Not detected	100		ug/kg	65.4		
o-Xylene	Not detected	70		ug/kg	65.4	95-47-6	
Styrene	Not detected	70		ug/kg	65.4	100-42-5	
Isopropylbenzene	Not detected	300		ug/kg	65.4	98-82-8	
Bromoform	Not detected	100		ug/kg	65.4	75-25-2	
1,1,2,2-Tetrachloroethane	Not detected	70		ug/kg	65.4	79-34-5	
1,2,3-Trichloropropane	Not detected	100		ug/kg	65.4	96-18-4	
n-Propylbenzene	Not detected	70		ug/kg	65.4	103-65-1	
Bromobenzene	Not detected	100		ug/kg	65.4	108-86-1	
1,3,5-Trimethylbenzene	Not detected	70		ug/kg	65.4	108-67-8	
tert-Butylbenzene	Not detected	70		ug/kg	65.4	98-06-6	
1,2,4-Trimethylbenzene	Not detected	70		ug/kg	65.4	95-63-6	
sec-Butylbenzene	Not detected	70		ug/kg	65.4	135-98-8	
p-Isopropyltoluene	Not detected	100		ug/kg	65.4	99-87-6	
1,3-Dichlorobenzene	Not detected	100		ug/kg	65.4	541-73-1	
1,4-Dichlorobenzene	Not detected	100		ug/kg	65.4	106-46-7	
1,2-Dichlorobenzene	Not detected	100		ug/kg	65.4	95-50-1	
1,2,3-Trimethylbenzene	Not detected	70		ug/kg	65.4	526-73-8	
n-Butylbenzene	Not detected	70		ug/kg	65.4	104-51-8	
Hexachloroethane	Not detected	400		ug/kg	65.4	67-72-1	
1,2-Dibromo-3-chloropropane	Not detected	300		ug/kg	65.4	96-12-8	
1,2,4-Trichlorobenzene	Not detected	430		ug/kg	65.4	120-82-1	
1,2,3-Trichlorobenzene	Not detected	430		ug/kg	65.4	87-61-6	
Naphthalene	Not detected	300		ug/kg	65.4	91-20-3	
2-Methylnaphthalene	Not detected	100		ug/kg	65.4	91-57-6	



# Analytical Laboratory Report

Lab Sample ID: S62474.03

Sample Tag: SB-2 (9-10')

Collected Date/Time: 05/22/2024 15:15

Matrix: Soil

COC Reference: 171234

### Sample Containers

#	Type	Preservative(s)	Refrigerated?	Arrival Temp. (C)	Thermometer #
1	4oz Glass	None	Yes	6.0	IR
1	125mL Plastic	None	Yes	6.0	IR
1	40mL Glass	MeOH	Yes	6.0	IR
1	15mL Centrifuge Tube	None	Yes	6.0	IR

### Extraction / Prep.

Parameter	Result	Method	Run Date	Analyst	Flags
Initial wt. (g) / Final wt. (g) / Volume (ml)*	7.81/6.46/10	ASTM D7968-17M	05/29/24 10:00	SRP	
Metal Digestion	Completed	SW3050B	05/31/24 09:30	JRH	
Extraction, PCB*	Completed	SW3546	05/28/24 12:30	DJS	
PNA Extraction*	Completed	SW3546	05/30/24 15:00	DJS	
Sample wt. (g) / Methanol (ml)*	11.393/11	SW5035A	05/24/24 11:38	NDK	
Mercury Digestion	Completed	SW7471B	05/24/24 11:58	CTV	

### Inorganics

Method: SM2540B, Run Date: 05/28/24 12:48, Analyst: MAM

Parameter	Result	RL	MDL	Units	Dilution	CAS#	Flags
Total Solids*	91	1		%	1		

### Metals

Method: SW6020A, Run Date: 05/31/24 12:30, Analyst: JRH

Parameter	Result	RL	MDL	Units	Dilution	CAS#	Flags
Arsenic	4.30	0.20		mg/kg	239	7440-38-2	
Barium	19.3	1.0		mg/kg	239	7440-39-3	
Cadmium	Not detected	0.20		mg/kg	239	7440-43-9	
Chromium	13.7	0.50		mg/kg	239	7440-47-3	
Copper	8.67	0.50		mg/kg	239	7440-50-8	
Lead	5.05	0.30		mg/kg	239	7439-92-1	
Selenium	Not detected	0.40		mg/kg	239	7782-49-2	
Silver	Not detected	0.20		mg/kg	239	7440-22-4	
Zinc	35.4	0.50		mg/kg	239	7440-66-6	

Method: SW7471B, Run Date: 05/24/24 15:20, Analyst: CTV

Parameter	Result	RL	MDL	Units	Dilution	CAS#	Flags
Mercury	Not detected	0.050		mg/kg	58	7439-97-6	

### Organics - PCBs/Pesticides

PCB List, Method: SW8082A, Run Date: 05/29/24 14:23, Analyst: JANB

Parameter	Result	RL	MDL	Units	Dilution	CAS#	Flags
PCB-1016	Not detected	330		ug/kg	5	12674-11-2	
PCB-1242	Not detected	330		ug/kg	5	53469-21-9	
PCB-1221	Not detected	330		ug/kg	5	11104-28-2	
PCB-1232	Not detected	330		ug/kg	5	11141-16-5	
PCB-1248	Not detected	330		ug/kg	5	12672-29-6	
PCB-1254	Not detected	330		ug/kg	5	11097-69-1	
PCB-1260	Not detected	330		ug/kg	5	11096-82-5	



# Analytical Laboratory Report

Lab Sample ID: S62474.03 (continued)

Sample Tag: SB-2 (9-10')

## Organics - Semi-Volatiles

Polynuclear Aromatics, Method: SW8270D, Run Date: 05/31/24 18:09, Analyst: PL

Parameter	Result	RL	MDL	Units	Dilution	CAS#	Flags
Acenaphthene	Not detected	300		ug/kg	10	83-32-9	
Acenaphthylene	Not detected	300		ug/kg	10	208-96-8	
Anthracene	Not detected	300		ug/kg	10	120-12-7	
Benzo(a)anthracene	Not detected	300		ug/kg	10	56-55-3	
Benzo(a)pyrene	Not detected	300		ug/kg	10	50-32-8	
Benzo(b)fluoranthene	Not detected	300		ug/kg	10	205-99-2	
Benzo(k)fluoranthene	Not detected	300		ug/kg	10	207-08-9	
Benzo(ghi)perylene	Not detected	300		ug/kg	10	191-24-2	
Chrysene	Not detected	300		ug/kg	10	218-01-9	
Dibenzo(ah)anthracene	Not detected	300		ug/kg	10	53-70-3	
Fluoranthene	Not detected	300		ug/kg	10	206-44-0	
Fluorene	Not detected	300		ug/kg	10	86-73-7	
Indeno(1,2,3-cd)pyrene	Not detected	300		ug/kg	10	193-39-5	
Naphthalene	Not detected	300		ug/kg	10	91-20-3	
Phenanthrene	Not detected	300		ug/kg	10	85-01-8	
Pyrene	Not detected	300		ug/kg	10	129-00-0	
2-Methylnaphthalene	Not detected	300		ug/kg	10	91-57-6	
1-Methylnaphthalene	Not detected	300		ug/kg	10	90-12-0	

## Organics

28 PFAs, Method: ASTM D7968-17M, Run Date: 05/29/24 17:28, Analyst: KCV

Parameter	Result	RL	MDL	Units	Dilution	CAS#	Flags
PFBA*	Not detected	160		ng/kg	8.14	375-22-4	
PFPeA*	Not detected	81		ng/kg	8.14	2706-90-3	
4:2 FTSA*	Not detected	81		ng/kg	8.14	757124-72-4	
PFHxA*	Not detected	81		ng/kg	8.14	307-24-4	
PFBS*	Not detected	81		ng/kg	8.14	375-73-5	
PFHpA*	Not detected	81		ng/kg	8.14	375-85-9	
PFPeS*	Not detected	81		ng/kg	8.14	2706-91-4	
6:2 FTSA*	Not detected	81		ng/kg	8.14	27619-97-2	
PFOA*	Not detected	81		ng/kg	8.14	335-67-1	
PFHxS*	Not detected	81		ng/kg	8.14	355-46-4	
PFHxS-LN*	Not detected	81		ng/kg	8.14	355-46-4-LN	
PFHxS-BR*	Not detected	81		ng/kg	8.14	355-46-4-BR	
PFNA*	Not detected	81		ng/kg	8.14	375-95-1	
8:2 FTSA*	Not detected	81		ng/kg	8.14	39108-34-4	
PFHpS*	Not detected	81		ng/kg	8.14	375-92-8	
PFDA*	Not detected	81		ng/kg	8.14	335-76-2	
N-MeFOSAA*	Not detected	81		ng/kg	8.14	2355-31-9	
EtFOSAA*	Not detected	81		ng/kg	8.14	2991-50-6	
PFOS*	Not detected	81		ng/kg	8.14	1763-23-1	
PFOS-LN*	Not detected	81		ng/kg	8.14	1763-23-1-LN	
PFOS-BR*	Not detected	81		ng/kg	8.14	1763-23-1-BR	
PFUnDA*	Not detected	81		ng/kg	8.14	2058-94-8	
PFNS*	Not detected	81		ng/kg	8.14	68259-12-1	
PFDODA*	Not detected	81		ng/kg	8.14	307-55-1	
PFDS*	Not detected	81		ng/kg	8.14	335-77-3	
PFTTrDA*	Not detected	81		ng/kg	8.14	72629-94-8	
FOSA*	Not detected	81		ng/kg	8.14	754-91-6	



# Analytical Laboratory Report

Lab Sample ID: S62474.03 (continued)

Sample Tag: SB-2 (9-10')

**28 PFAs, Method: ASTM D7968-17M, Run Date: 05/29/24 17:28, Analyst: KCV (continued)**

Parameter	Result	RL	MDL	Units	Dilution	CAS#	Flags
PFTeDA*	Not detected	81		ng/kg	8.14	376-06-7	
11Cl-PF3OUdS*	Not detected	81		ng/kg	8.14	763051-92-9	
9Cl-PF3ONS*	Not detected	81		ng/kg	8.14	756426-58-1	
ADONA*	Not detected	81		ng/kg	8.14	919005-14-4	
HFPO-DA*	Not detected	81		ng/kg	8.14	13252-13-6	

**Volatile Organics 5035, Method: SW5035A/8260C, Run Date: 05/25/24 15:51, Analyst: KAG**

Parameter	Result	RL	MDL	Units	Dilution	CAS#	Flags
Diethyl ether	Not detected	200		ug/kg	58	60-29-7	
Acetone	Not detected	1,000		ug/kg	58	67-64-1	
Methyl iodide	Not detected	100		ug/kg	58	74-88-4	
Carbon disulfide	Not detected	300		ug/kg	58	75-15-0	
tert-Methyl butyl ether (MTBE)	Not detected	200		ug/kg	58	1634-04-4	
Acrylonitrile	Not detected	100		ug/kg	58	107-13-1	
2-Butanone (MEK)	Not detected	870		ug/kg	58	78-93-3	
Dichlorodifluoromethane	Not detected	300		ug/kg	58	75-71-8	
Chloromethane	Not detected	300		ug/kg	58	74-87-3	
Vinyl chloride	Not detected	60		ug/kg	58	75-01-4	
Bromomethane	Not detected	200		ug/kg	58	74-83-9	
Chloroethane	Not detected	300		ug/kg	58	75-00-3	
Trichlorofluoromethane	Not detected	100		ug/kg	58	75-69-4	
1,1-Dichloroethene	Not detected	60		ug/kg	58	75-35-4	
Methylene chloride	Not detected	100		ug/kg	58	75-09-2	
trans-1,2-Dichloroethene	Not detected	60		ug/kg	58	156-60-5	
1,1-Dichloroethane	Not detected	60		ug/kg	58	75-34-3	
cis-1,2-Dichloroethene	Not detected	60		ug/kg	58	156-59-2	
Tetrahydrofuran*	Not detected	1,000		ug/kg	58	109-99-9	
Chloroform	Not detected	60		ug/kg	58	67-66-3	
Bromochloromethane	Not detected	100		ug/kg	58	74-97-5	
1,1,1-Trichloroethane	Not detected	60		ug/kg	58	71-55-6	
4-Methyl-2-pentanone (MIBK)	Not detected	3,000		ug/kg	58	108-10-1	
2-Hexanone	Not detected	3,000		ug/kg	58	591-78-6	
Carbon tetrachloride	Not detected	60		ug/kg	58	56-23-5	
Benzene	Not detected	60		ug/kg	58	71-43-2	
1,2-Dichloroethane	Not detected	60		ug/kg	58	107-06-2	
Trichloroethene	Not detected	60		ug/kg	58	79-01-6	
1,2-Dichloropropane	Not detected	60		ug/kg	58	78-87-5	
Bromodichloromethane	Not detected	100		ug/kg	58	75-27-4	
Dibromomethane	Not detected	300		ug/kg	58	74-95-3	
cis-1,3-Dichloropropene	Not detected	60		ug/kg	58	10061-01-5	
Toluene	Not detected	60		ug/kg	58	108-88-3	
trans-1,3-Dichloropropene	Not detected	60		ug/kg	58	10061-02-6	
1,1,2-Trichloroethane	Not detected	60		ug/kg	58	79-00-5	
Tetrachloroethene	Not detected	60		ug/kg	58	127-18-4	
trans-1,4-Dichloro-2-butene	Not detected	60		ug/kg	58	110-57-6	
Dibromochloromethane	Not detected	100		ug/kg	58	124-48-1	
1,2-Dibromoethane	Not detected	20		ug/kg	58	106-93-4	M
Chlorobenzene	Not detected	60		ug/kg	58	108-90-7	
1,1,1,2-Tetrachloroethane	Not detected	100		ug/kg	58	630-20-6	

M-Result reported to MDL not RDL



# Analytical Laboratory Report

Lab Sample ID: S62474.03 (continued)

Sample Tag: SB-2 (9-10')

**Volatile Organics 5035, Method: SW5035A/8260C, Run Date: 05/25/24 15:51, Analyst: KAG (continued)**

Parameter	Result	RL	MDL	Units	Dilution	CAS#	Flags
Ethylbenzene	Not detected	60		ug/kg	58	100-41-4	
p,m-Xylene	Not detected	100		ug/kg	58		
o-Xylene	Not detected	60		ug/kg	58	95-47-6	
Styrene	Not detected	60		ug/kg	58	100-42-5	
Isopropylbenzene	Not detected	300		ug/kg	58	98-82-8	
Bromoform	Not detected	100		ug/kg	58	75-25-2	
1,1,2,2-Tetrachloroethane	Not detected	60		ug/kg	58	79-34-5	
1,2,3-Trichloropropane	Not detected	100		ug/kg	58	96-18-4	
n-Propylbenzene	Not detected	60		ug/kg	58	103-65-1	
Bromobenzene	Not detected	100		ug/kg	58	108-86-1	
1,3,5-Trimethylbenzene	Not detected	60		ug/kg	58	108-67-8	
tert-Butylbenzene	Not detected	60		ug/kg	58	98-06-6	
1,2,4-Trimethylbenzene	Not detected	60		ug/kg	58	95-63-6	
sec-Butylbenzene	Not detected	60		ug/kg	58	135-98-8	
p-Isopropyltoluene	Not detected	100		ug/kg	58	99-87-6	
1,3-Dichlorobenzene	Not detected	100		ug/kg	58	541-73-1	
1,4-Dichlorobenzene	Not detected	100		ug/kg	58	106-46-7	
1,2-Dichlorobenzene	Not detected	100		ug/kg	58	95-50-1	
1,2,3-Trimethylbenzene	Not detected	60		ug/kg	58	526-73-8	
n-Butylbenzene	Not detected	60		ug/kg	58	104-51-8	
Hexachloroethane	Not detected	300		ug/kg	58	67-72-1	
1,2-Dibromo-3-chloropropane	Not detected	300		ug/kg	58	96-12-8	
1,2,4-Trichlorobenzene	Not detected	380		ug/kg	58	120-82-1	
1,2,3-Trichlorobenzene	Not detected	380		ug/kg	58	87-61-6	
Naphthalene	Not detected	300		ug/kg	58	91-20-3	
2-Methylnaphthalene	Not detected	100		ug/kg	58	91-57-6	



# Analytical Laboratory Report

Lab Sample ID: S62474.04

Sample Tag: SB-2 (10-11')

Collected Date/Time: 05/22/2024 15:20

Matrix: Soil

COC Reference: 171234

### Sample Containers

#	Type	Preservative(s)	Refrigerated?	Arrival Temp. (C)	Thermometer #
1	4oz Glass	None	Yes	6.0	IR
1	125mL Plastic	None	Yes	6.0	IR
1	40mL Glass	MeOH	Yes	6.0	IR
1	15mL Centrifuge Tube	None	Yes	6.0	IR

### Extraction / Prep.

Parameter	Result	Method	Run Date	Analyst	Flags
Initial wt. (g) / Final wt. (g) / Volume (ml)*	7.99/6.45/10	ASTM D7968-17M	05/29/24 10:00	SRP	
Metal Digestion	Completed	SW3050B	05/31/24 09:30	JRH	
Extraction, PCB*	Completed	SW3546	05/28/24 12:30	DJS	
PNA Extraction*	Completed	SW3546	05/30/24 15:00	DJS	
Sample wt. (g) / Methanol (ml)*	11.403/11	SW5035A	05/24/24 11:38	NDK	
Mercury Digestion	Completed	SW7471B	05/24/24 11:58	CTV	

### Inorganics

Method: SM2540B, Run Date: 05/28/24 12:48, Analyst: MAM

Parameter	Result	RL	MDL	Units	Dilution	CAS#	Flags
Total Solids*	93	1		%	1		

### Metals

Method: SW6020A, Run Date: 05/31/24 12:33, Analyst: JRH

Parameter	Result	RL	MDL	Units	Dilution	CAS#	Flags
Arsenic	6.10	0.20		mg/kg	226	7440-38-2	
Barium	11.8	1.0		mg/kg	226	7440-39-3	
Cadmium	Not detected	0.20		mg/kg	226	7440-43-9	
Chromium	4.63	0.50		mg/kg	226	7440-47-3	
Copper	7.93	0.50		mg/kg	226	7440-50-8	
Lead	3.40	0.30		mg/kg	226	7439-92-1	
Selenium	Not detected	0.40		mg/kg	226	7782-49-2	
Silver	Not detected	0.20		mg/kg	226	7440-22-4	
Zinc	22.9	0.50		mg/kg	226	7440-66-6	

Method: SW7471B, Run Date: 05/24/24 15:23, Analyst: CTV

Parameter	Result	RL	MDL	Units	Dilution	CAS#	Flags
Mercury	Not detected	0.050		mg/kg	64	7439-97-6	

### Organics - PCBs/Pesticides

PCB List, Method: SW8082A, Run Date: 05/29/24 14:36, Analyst: JANB

Parameter	Result	RL	MDL	Units	Dilution	CAS#	Flags
PCB-1016	Not detected	330		ug/kg	5	12674-11-2	
PCB-1242	Not detected	330		ug/kg	5	53469-21-9	
PCB-1221	Not detected	330		ug/kg	5	11104-28-2	
PCB-1232	Not detected	330		ug/kg	5	11141-16-5	
PCB-1248	Not detected	330		ug/kg	5	12672-29-6	
PCB-1254	Not detected	330		ug/kg	5	11097-69-1	
PCB-1260	Not detected	330		ug/kg	5	11096-82-5	



# Analytical Laboratory Report

Lab Sample ID: S62474.04 (continued)

Sample Tag: SB-2 (10-11')

## Organics - Semi-Volatiles

Polynuclear Aromatics, Method: SW8270D, Run Date: 05/31/24 18:26, Analyst: PL

Parameter	Result	RL	MDL	Units	Dilution	CAS#	Flags
Acenaphthene	Not detected	300		ug/kg	10	83-32-9	
Acenaphthylene	Not detected	300		ug/kg	10	208-96-8	
Anthracene	Not detected	300		ug/kg	10	120-12-7	
Benzo(a)anthracene	Not detected	300		ug/kg	10	56-55-3	
Benzo(a)pyrene	Not detected	300		ug/kg	10	50-32-8	
Benzo(b)fluoranthene	Not detected	300		ug/kg	10	205-99-2	
Benzo(k)fluoranthene	Not detected	300		ug/kg	10	207-08-9	
Benzo(ghi)perylene	Not detected	300		ug/kg	10	191-24-2	
Chrysene	Not detected	300		ug/kg	10	218-01-9	
Dibenzo(ah)anthracene	Not detected	300		ug/kg	10	53-70-3	
Fluoranthene	Not detected	300		ug/kg	10	206-44-0	
Fluorene	Not detected	300		ug/kg	10	86-73-7	
Indeno(1,2,3-cd)pyrene	Not detected	300		ug/kg	10	193-39-5	
Naphthalene	Not detected	300		ug/kg	10	91-20-3	
Phenanthrene	Not detected	300		ug/kg	10	85-01-8	
Pyrene	Not detected	300		ug/kg	10	129-00-0	
2-Methylnaphthalene	Not detected	300		ug/kg	10	91-57-6	
1-Methylnaphthalene	Not detected	300		ug/kg	10	90-12-0	

## Organics

28 PFAs, Method: ASTM D7968-17M, Run Date: 05/29/24 17:48, Analyst: KCV

Parameter	Result	RL	MDL	Units	Dilution	CAS#	Flags
PFBA*	Not detected	140		ng/kg	6.98	375-22-4	
PFPeA*	Not detected	70		ng/kg	6.98	2706-90-3	
4:2 FTSA*	Not detected	70		ng/kg	6.98	757124-72-4	
PFHxA*	Not detected	70		ng/kg	6.98	307-24-4	
PFBS*	Not detected	70		ng/kg	6.98	375-73-5	
PFHpA*	Not detected	70		ng/kg	6.98	375-85-9	
PFPeS*	Not detected	70		ng/kg	6.98	2706-91-4	
6:2 FTSA*	Not detected	70		ng/kg	6.98	27619-97-2	
PFOA*	Not detected	70		ng/kg	6.98	335-67-1	
PFHxS*	Not detected	70		ng/kg	6.98	355-46-4	
PFHxS-LN*	Not detected	70		ng/kg	6.98	355-46-4-LN	
PFHxS-BR*	Not detected	70		ng/kg	6.98	355-46-4-BR	
PFNA*	Not detected	70		ng/kg	6.98	375-95-1	
8:2 FTSA*	Not detected	70		ng/kg	6.98	39108-34-4	
PFHpS*	Not detected	70		ng/kg	6.98	375-92-8	
PFDA*	Not detected	70		ng/kg	6.98	335-76-2	
N-MeFOSAA*	Not detected	70		ng/kg	6.98	2355-31-9	
EtFOSAA*	Not detected	70		ng/kg	6.98	2991-50-6	
PFOS*	Not detected	70		ng/kg	6.98	1763-23-1	
PFOS-LN*	Not detected	70		ng/kg	6.98	1763-23-1-LN	
PFOS-BR*	Not detected	70		ng/kg	6.98	1763-23-1-BR	
PFUnDA*	Not detected	70		ng/kg	6.98	2058-94-8	
PFNS*	Not detected	70		ng/kg	6.98	68259-12-1	
PFDODA*	Not detected	70		ng/kg	6.98	307-55-1	
PFDS*	Not detected	70		ng/kg	6.98	335-77-3	
PFTTrDA*	Not detected	70		ng/kg	6.98	72629-94-8	
FOSA*	Not detected	70		ng/kg	6.98	754-91-6	



# Analytical Laboratory Report

Lab Sample ID: S62474.04 (continued)

Sample Tag: SB-2 (10-11')

**28 PFAs, Method: ASTM D7968-17M, Run Date: 05/29/24 17:48, Analyst: KCV (continued)**

Parameter	Result	RL	MDL	Units	Dilution	CAS#	Flags
PFTeDA*	Not detected	70		ng/kg	6.98	376-06-7	
11Cl-PF3OUdS*	Not detected	70		ng/kg	6.98	763051-92-9	
9Cl-PF3ONS*	Not detected	70		ng/kg	6.98	756426-58-1	
ADONA*	Not detected	70		ng/kg	6.98	919005-14-4	
HFPO-DA*	Not detected	70		ng/kg	6.98	13252-13-6	

**Volatile Organics 5035, Method: SW5035A/8260C, Run Date: 05/25/24 16:14, Analyst: KAG**

Parameter	Result	RL	MDL	Units	Dilution	CAS#	Flags
Diethyl ether	Not detected	200		ug/kg	55.6	60-29-7	
Acetone	Not detected	1,000		ug/kg	55.6	67-64-1	
Methyl iodide	Not detected	100		ug/kg	55.6	74-88-4	
Carbon disulfide	Not detected	300		ug/kg	55.6	75-15-0	
tert-Methyl butyl ether (MTBE)	Not detected	200		ug/kg	55.6	1634-04-4	
Acrylonitrile	Not detected	100		ug/kg	55.6	107-13-1	
2-Butanone (MEK)	Not detected	830		ug/kg	55.6	78-93-3	
Dichlorodifluoromethane	Not detected	300		ug/kg	55.6	75-71-8	
Chloromethane	Not detected	300		ug/kg	55.6	74-87-3	
Vinyl chloride	Not detected	60		ug/kg	55.6	75-01-4	
Bromomethane	Not detected	200		ug/kg	55.6	74-83-9	
Chloroethane	Not detected	300		ug/kg	55.6	75-00-3	
Trichlorofluoromethane	Not detected	100		ug/kg	55.6	75-69-4	
1,1-Dichloroethene	Not detected	60		ug/kg	55.6	75-35-4	
Methylene chloride	Not detected	100		ug/kg	55.6	75-09-2	
trans-1,2-Dichloroethene	Not detected	60		ug/kg	55.6	156-60-5	
1,1-Dichloroethane	Not detected	60		ug/kg	55.6	75-34-3	
cis-1,2-Dichloroethene	Not detected	60		ug/kg	55.6	156-59-2	
Tetrahydrofuran*	Not detected	1,000		ug/kg	55.6	109-99-9	
Chloroform	Not detected	60		ug/kg	55.6	67-66-3	
Bromochloromethane	Not detected	100		ug/kg	55.6	74-97-5	
1,1,1-Trichloroethane	Not detected	60		ug/kg	55.6	71-55-6	
4-Methyl-2-pentanone (MIBK)	Not detected	3,000		ug/kg	55.6	108-10-1	
2-Hexanone	Not detected	3,000		ug/kg	55.6	591-78-6	
Carbon tetrachloride	Not detected	60		ug/kg	55.6	56-23-5	
Benzene	Not detected	60		ug/kg	55.6	71-43-2	
1,2-Dichloroethane	Not detected	60		ug/kg	55.6	107-06-2	
Trichloroethene	Not detected	60		ug/kg	55.6	79-01-6	
1,2-Dichloropropane	Not detected	60		ug/kg	55.6	78-87-5	
Bromodichloromethane	Not detected	100		ug/kg	55.6	75-27-4	
Dibromomethane	Not detected	300		ug/kg	55.6	74-95-3	
cis-1,3-Dichloropropene	Not detected	60		ug/kg	55.6	10061-01-5	
Toluene	Not detected	60		ug/kg	55.6	108-88-3	
trans-1,3-Dichloropropene	Not detected	60		ug/kg	55.6	10061-02-6	
1,1,2-Trichloroethane	Not detected	60		ug/kg	55.6	79-00-5	
Tetrachloroethene	Not detected	60		ug/kg	55.6	127-18-4	
trans-1,4-Dichloro-2-butene	Not detected	60		ug/kg	55.6	110-57-6	
Dibromochloromethane	Not detected	100		ug/kg	55.6	124-48-1	
1,2-Dibromoethane	Not detected	20		ug/kg	55.6	106-93-4	M
Chlorobenzene	Not detected	60		ug/kg	55.6	108-90-7	
1,1,1,2-Tetrachloroethane	Not detected	100		ug/kg	55.6	630-20-6	

M-Result reported to MDL not RDL





# Analytical Laboratory Report

Lab Sample ID: S62474.04 (continued)

Sample Tag: SB-2 (10-11')

**Volatile Organics 5035, Method: SW5035A/8260C, Run Date: 05/25/24 16:14, Analyst: KAG (continued)**

Parameter	Result	RL	MDL	Units	Dilution	CAS#	Flags
Ethylbenzene	Not detected	60		ug/kg	55.6	100-41-4	
p,m-Xylene	Not detected	100		ug/kg	55.6		
o-Xylene	Not detected	60		ug/kg	55.6	95-47-6	
Styrene	Not detected	60		ug/kg	55.6	100-42-5	
Isopropylbenzene	Not detected	300		ug/kg	55.6	98-82-8	
Bromoform	Not detected	100		ug/kg	55.6	75-25-2	
1,1,2,2-Tetrachloroethane	Not detected	60		ug/kg	55.6	79-34-5	
1,2,3-Trichloropropane	Not detected	100		ug/kg	55.6	96-18-4	
n-Propylbenzene	Not detected	60		ug/kg	55.6	103-65-1	
Bromobenzene	Not detected	100		ug/kg	55.6	108-86-1	
1,3,5-Trimethylbenzene	Not detected	60		ug/kg	55.6	108-67-8	
tert-Butylbenzene	Not detected	60		ug/kg	55.6	98-06-6	
1,2,4-Trimethylbenzene	Not detected	60		ug/kg	55.6	95-63-6	
sec-Butylbenzene	Not detected	60		ug/kg	55.6	135-98-8	
p-Isopropyltoluene	Not detected	100		ug/kg	55.6	99-87-6	
1,3-Dichlorobenzene	Not detected	100		ug/kg	55.6	541-73-1	
1,4-Dichlorobenzene	Not detected	100		ug/kg	55.6	106-46-7	
1,2-Dichlorobenzene	Not detected	100		ug/kg	55.6	95-50-1	
1,2,3-Trimethylbenzene	Not detected	60		ug/kg	55.6	526-73-8	
n-Butylbenzene	Not detected	60		ug/kg	55.6	104-51-8	
Hexachloroethane	Not detected	300		ug/kg	55.6	67-72-1	
1,2-Dibromo-3-chloropropane	Not detected	300		ug/kg	55.6	96-12-8	
1,2,4-Trichlorobenzene	Not detected	370		ug/kg	55.6	120-82-1	
1,2,3-Trichlorobenzene	Not detected	370		ug/kg	55.6	87-61-6	
Naphthalene	Not detected	300		ug/kg	55.6	91-20-3	
2-Methylnaphthalene	Not detected	100		ug/kg	55.6	91-57-6	



# Analytical Laboratory Report

Lab Sample ID: S62474.05

Sample Tag: SB-3 (9-10)

Collected Date/Time: 05/22/2024 14:15

Matrix: Soil

COC Reference: 171234

### Sample Containers

#	Type	Preservative(s)	Refrigerated?	Arrival Temp. (C)	Thermometer #
1	4oz Glass	None	Yes	6.0	IR
1	125mL Plastic	None	Yes	6.0	IR
1	40mL Glass	MeOH	Yes	6.0	IR
1	15mL Centrifuge Tube	None	Yes	6.0	IR

### Extraction / Prep.

Parameter	Result	Method	Run Date	Analyst	Flags
Initial wt. (g) / Final wt. (g) / Volume (ml)*	7.44/6.42/10	ASTM D7968-17M	05/29/24 10:00	SRP	
Metal Digestion	Completed	SW3050B	05/31/24 09:30	JRH	
Extraction, PCB*	Completed	SW3546	05/24/24 11:00	DJS	
PNA Extraction*	Completed	SW3546	05/30/24 15:00	DJS	
Sample wt. (g) / Methanol (ml)*	11.122/11	SW5035A	05/24/24 11:38	NDK	
Mercury Digestion	Completed	SW7471B	05/24/24 11:58	CTV	

### Inorganics

Method: SM2540B, Run Date: 05/28/24 12:48, Analyst: MAM

Parameter	Result	RL	MDL	Units	Dilution	CAS#	Flags
Total Solids*	93	1		%	1		

### Metals

Method: SW6020A, Run Date: 05/31/24 12:36, Analyst: JRH

Parameter	Result	RL	MDL	Units	Dilution	CAS#	Flags
Arsenic	4.92	0.20		mg/kg	233	7440-38-2	
Barium	16.1	1.0		mg/kg	233	7440-39-3	
Cadmium	Not detected	0.20		mg/kg	233	7440-43-9	
Chromium	13.2	0.50		mg/kg	233	7440-47-3	
Copper	9.15	0.50		mg/kg	233	7440-50-8	
Lead	6.44	0.30		mg/kg	233	7439-92-1	
Selenium	Not detected	0.40		mg/kg	233	7782-49-2	
Silver	Not detected	0.20		mg/kg	233	7440-22-4	
Zinc	28.3	0.50		mg/kg	233	7440-66-6	

Method: SW7471B, Run Date: 05/24/24 15:27, Analyst: CTV

Parameter	Result	RL	MDL	Units	Dilution	CAS#	Flags
Mercury	Not detected	0.050		mg/kg	65	7439-97-6	

### Organics - PCBs/Pesticides

PCB List, Method: SW8082A, Run Date: 05/28/24 17:48, Analyst: JANB

Parameter	Result	RL	MDL	Units	Dilution	CAS#	Flags
PCB-1016	Not detected	330		ug/kg	5	12674-11-2	
PCB-1242	Not detected	330		ug/kg	5	53469-21-9	
PCB-1221	Not detected	330		ug/kg	5	11104-28-2	
PCB-1232	Not detected	330		ug/kg	5	11141-16-5	
PCB-1248	Not detected	330		ug/kg	5	12672-29-6	
PCB-1254	Not detected	330		ug/kg	5	11097-69-1	
PCB-1260	Not detected	330		ug/kg	5	11096-82-5	



# Analytical Laboratory Report

Lab Sample ID: S62474.05 (continued)

Sample Tag: SB-3 (9-10)

## Organics - Semi-Volatiles

Polynuclear Aromatics, Method: SW8270D, Run Date: 05/31/24 18:43, Analyst: PL

Parameter	Result	RL	MDL	Units	Dilution	CAS#	Flags
Acenaphthene	Not detected	300		ug/kg	10	83-32-9	
Acenaphthylene	Not detected	300		ug/kg	10	208-96-8	
Anthracene	Not detected	300		ug/kg	10	120-12-7	
Benzo(a)anthracene	Not detected	300		ug/kg	10	56-55-3	
Benzo(a)pyrene	Not detected	300		ug/kg	10	50-32-8	
Benzo(b)fluoranthene	Not detected	300		ug/kg	10	205-99-2	
Benzo(k)fluoranthene	Not detected	300		ug/kg	10	207-08-9	
Benzo(ghi)perylene	Not detected	300		ug/kg	10	191-24-2	
Chrysene	Not detected	300		ug/kg	10	218-01-9	
Dibenzo(ah)anthracene	Not detected	300		ug/kg	10	53-70-3	
Fluoranthene	Not detected	300		ug/kg	10	206-44-0	
Fluorene	Not detected	300		ug/kg	10	86-73-7	
Indeno(1,2,3-cd)pyrene	Not detected	300		ug/kg	10	193-39-5	
Naphthalene	Not detected	300		ug/kg	10	91-20-3	
Phenanthrene	Not detected	300		ug/kg	10	85-01-8	
Pyrene	Not detected	300		ug/kg	10	129-00-0	
2-Methylnaphthalene	Not detected	300		ug/kg	10	91-57-6	
1-Methylnaphthalene	Not detected	300		ug/kg	10	90-12-0	

## Organics

28 PFAs, Method: ASTM D7968-17M, Run Date: 05/29/24 18:08, Analyst: KCV

Parameter	Result	RL	MDL	Units	Dilution	CAS#	Flags
PFBA*	Not detected	210		ng/kg	10.5	375-22-4	
PFPeA*	Not detected	110		ng/kg	10.5	2706-90-3	
4:2 FTSA*	Not detected	110		ng/kg	10.5	757124-72-4	
PFHxA*	Not detected	110		ng/kg	10.5	307-24-4	
PFBS*	Not detected	110		ng/kg	10.5	375-73-5	
PFHpA*	Not detected	110		ng/kg	10.5	375-85-9	
PFPeS*	Not detected	110		ng/kg	10.5	2706-91-4	
6:2 FTSA*	Not detected	110		ng/kg	10.5	27619-97-2	
PFOA*	Not detected	110		ng/kg	10.5	335-67-1	
PFHxS*	Not detected	110		ng/kg	10.5	355-46-4	
PFHxS-LN*	Not detected	110		ng/kg	10.5	355-46-4-LN	
PFHxS-BR*	Not detected	110		ng/kg	10.5	355-46-4-BR	
PFNA*	Not detected	110		ng/kg	10.5	375-95-1	
8:2 FTSA*	Not detected	110		ng/kg	10.5	39108-34-4	
PFHpS*	Not detected	110		ng/kg	10.5	375-92-8	
PFDA*	Not detected	110		ng/kg	10.5	335-76-2	
N-MeFOSAA*	Not detected	110		ng/kg	10.5	2355-31-9	
EtFOSAA*	Not detected	110		ng/kg	10.5	2991-50-6	
PFOS*	Not detected	110		ng/kg	10.5	1763-23-1	
PFOS-LN*	Not detected	110		ng/kg	10.5	1763-23-1-LN	
PFOS-BR*	Not detected	110		ng/kg	10.5	1763-23-1-BR	
PFUnDA*	Not detected	110		ng/kg	10.5	2058-94-8	
PFNS*	Not detected	110		ng/kg	10.5	68259-12-1	
PFDoDA*	Not detected	110		ng/kg	10.5	307-55-1	
PFDS*	Not detected	110		ng/kg	10.5	335-77-3	
PFTTrDA*	Not detected	110		ng/kg	10.5	72629-94-8	
FOSA*	Not detected	110		ng/kg	10.5	754-91-6	



# Analytical Laboratory Report

Lab Sample ID: S62474.05 (continued)

Sample Tag: SB-3 (9-10)

**28 PFAs, Method: ASTM D7968-17M, Run Date: 05/29/24 18:08, Analyst: KCV (continued)**

Parameter	Result	RL	MDL	Units	Dilution	CAS#	Flags
PFTeDA*	Not detected	110		ng/kg	10.5	376-06-7	
11Cl-PF3OUdS*	Not detected	110		ng/kg	10.5	763051-92-9	
9Cl-PF3ONS*	Not detected	110		ng/kg	10.5	756426-58-1	
ADONA*	Not detected	110		ng/kg	10.5	919005-14-4	
HFPO-DA*	Not detected	110		ng/kg	10.5	13252-13-6	

**Volatile Organics 5035, Method: SW5035A/8260C, Run Date: 05/25/24 16:38, Analyst: KAG**

Parameter	Result	RL	MDL	Units	Dilution	CAS#	Flags
Diethyl ether	Not detected	200		ug/kg	56.9	60-29-7	
Acetone	Not detected	1,000		ug/kg	56.9	67-64-1	
Methyl iodide	Not detected	100		ug/kg	56.9	74-88-4	
Carbon disulfide	Not detected	300		ug/kg	56.9	75-15-0	
tert-Methyl butyl ether (MTBE)	Not detected	200		ug/kg	56.9	1634-04-4	
Acrylonitrile	Not detected	100		ug/kg	56.9	107-13-1	
2-Butanone (MEK)	Not detected	850		ug/kg	56.9	78-93-3	
Dichlorodifluoromethane	Not detected	300		ug/kg	56.9	75-71-8	
Chloromethane	Not detected	300		ug/kg	56.9	74-87-3	
Vinyl chloride	Not detected	60		ug/kg	56.9	75-01-4	
Bromomethane	Not detected	200		ug/kg	56.9	74-83-9	
Chloroethane	Not detected	300		ug/kg	56.9	75-00-3	
Trichlorofluoromethane	Not detected	100		ug/kg	56.9	75-69-4	
1,1-Dichloroethene	Not detected	60		ug/kg	56.9	75-35-4	
Methylene chloride	Not detected	100		ug/kg	56.9	75-09-2	
trans-1,2-Dichloroethene	Not detected	60		ug/kg	56.9	156-60-5	
1,1-Dichloroethane	Not detected	60		ug/kg	56.9	75-34-3	
cis-1,2-Dichloroethene	Not detected	60		ug/kg	56.9	156-59-2	
Tetrahydrofuran*	Not detected	1,000		ug/kg	56.9	109-99-9	
Chloroform	Not detected	60		ug/kg	56.9	67-66-3	
Bromochloromethane	Not detected	100		ug/kg	56.9	74-97-5	
1,1,1-Trichloroethane	Not detected	60		ug/kg	56.9	71-55-6	
4-Methyl-2-pentanone (MIBK)	Not detected	3,000		ug/kg	56.9	108-10-1	
2-Hexanone	Not detected	3,000		ug/kg	56.9	591-78-6	
Carbon tetrachloride	Not detected	60		ug/kg	56.9	56-23-5	
Benzene	Not detected	60		ug/kg	56.9	71-43-2	
1,2-Dichloroethane	Not detected	60		ug/kg	56.9	107-06-2	
Trichloroethene	Not detected	60		ug/kg	56.9	79-01-6	
1,2-Dichloropropane	Not detected	60		ug/kg	56.9	78-87-5	
Bromodichloromethane	Not detected	100		ug/kg	56.9	75-27-4	
Dibromomethane	Not detected	300		ug/kg	56.9	74-95-3	
cis-1,3-Dichloropropene	Not detected	60		ug/kg	56.9	10061-01-5	
Toluene	Not detected	60		ug/kg	56.9	108-88-3	
trans-1,3-Dichloropropene	Not detected	60		ug/kg	56.9	10061-02-6	
1,1,2-Trichloroethane	Not detected	60		ug/kg	56.9	79-00-5	
Tetrachloroethene	Not detected	60		ug/kg	56.9	127-18-4	
trans-1,4-Dichloro-2-butene	Not detected	60		ug/kg	56.9	110-57-6	
Dibromochloromethane	Not detected	100		ug/kg	56.9	124-48-1	
1,2-Dibromoethane	Not detected	20		ug/kg	56.9	106-93-4	M
Chlorobenzene	Not detected	60		ug/kg	56.9	108-90-7	
1,1,1,2-Tetrachloroethane	Not detected	100		ug/kg	56.9	630-20-6	

M-Result reported to MDL not RDL



# Analytical Laboratory Report

Lab Sample ID: S62474.05 (continued)

Sample Tag: SB-3 (9-10)

**Volatile Organics 5035, Method: SW5035A/8260C, Run Date: 05/25/24 16:38, Analyst: KAG (continued)**

Parameter	Result	RL	MDL	Units	Dilution	CAS#	Flags
Ethylbenzene	Not detected	60		ug/kg	56.9	100-41-4	
p,m-Xylene	Not detected	100		ug/kg	56.9		
o-Xylene	Not detected	60		ug/kg	56.9	95-47-6	
Styrene	Not detected	60		ug/kg	56.9	100-42-5	
Isopropylbenzene	Not detected	300		ug/kg	56.9	98-82-8	
Bromoform	Not detected	100		ug/kg	56.9	75-25-2	
1,1,2,2-Tetrachloroethane	Not detected	60		ug/kg	56.9	79-34-5	
1,2,3-Trichloropropane	Not detected	100		ug/kg	56.9	96-18-4	
n-Propylbenzene	Not detected	60		ug/kg	56.9	103-65-1	
Bromobenzene	Not detected	100		ug/kg	56.9	108-86-1	
1,3,5-Trimethylbenzene	Not detected	60		ug/kg	56.9	108-67-8	
tert-Butylbenzene	Not detected	60		ug/kg	56.9	98-06-6	
1,2,4-Trimethylbenzene	Not detected	60		ug/kg	56.9	95-63-6	
sec-Butylbenzene	Not detected	60		ug/kg	56.9	135-98-8	
p-Isopropyltoluene	Not detected	100		ug/kg	56.9	99-87-6	
1,3-Dichlorobenzene	Not detected	100		ug/kg	56.9	541-73-1	
1,4-Dichlorobenzene	Not detected	100		ug/kg	56.9	106-46-7	
1,2-Dichlorobenzene	Not detected	100		ug/kg	56.9	95-50-1	
1,2,3-Trimethylbenzene	Not detected	60		ug/kg	56.9	526-73-8	
n-Butylbenzene	Not detected	60		ug/kg	56.9	104-51-8	
Hexachloroethane	Not detected	300		ug/kg	56.9	67-72-1	
1,2-Dibromo-3-chloropropane	Not detected	300		ug/kg	56.9	96-12-8	
1,2,4-Trichlorobenzene	Not detected	380		ug/kg	56.9	120-82-1	
1,2,3-Trichlorobenzene	Not detected	380		ug/kg	56.9	87-61-6	
Naphthalene	Not detected	300		ug/kg	56.9	91-20-3	
2-Methylnaphthalene	Not detected	100		ug/kg	56.9	91-57-6	



# Analytical Laboratory Report

Lab Sample ID: S62474.06

Sample Tag: SB-3 (10-11')

Collected Date/Time: 05/22/2024 14:20

Matrix: Soil

COC Reference: 171234

### Sample Containers

#	Type	Preservative(s)	Refrigerated?	Arrival Temp. (C)	Thermometer #
1	4oz Glass	None	Yes	6.0	IR
1	125mL Plastic	None	Yes	6.0	IR
1	40mL Glass	MeOH	Yes	6.0	IR
1	15mL Centrifuge Tube	None	Yes	6.0	IR

### Extraction / Prep.

Parameter	Result	Method	Run Date	Analyst	Flags
Initial wt. (g) / Final wt. (g) / Volume (ml)*	8.85/6.41/10	ASTM D7968-17M	05/29/24 10:00	SRP	
Metal Digestion	Completed	SW3050B	05/31/24 09:30	JRH	
Extraction, PCB*	Completed	SW3546	05/24/24 11:00	DJS	
PNA Extraction*	Completed	SW3546	05/30/24 15:00	DJS	
Sample wt. (g) / Methanol (ml)*	11.220/11	SW5035A	05/24/24 11:38	NDK	
Mercury Digestion	Completed	SW7471B	05/24/24 11:58	CTV	

### Inorganics

Method: SM2540B, Run Date: 05/28/24 12:48, Analyst: MAM

Parameter	Result	RL	MDL	Units	Dilution	CAS#	Flags
Total Solids*	94	1		%	1		

### Metals

Method: SW6020A, Run Date: 05/31/24 12:39, Analyst: JRH

Parameter	Result	RL	MDL	Units	Dilution	CAS#	Flags
Arsenic	4.58	0.20		mg/kg	226	7440-38-2	
Barium	11.0	1.0		mg/kg	226	7440-39-3	
Cadmium	Not detected	0.20		mg/kg	226	7440-43-9	
Chromium	7.11	0.50		mg/kg	226	7440-47-3	
Copper	11.6	0.50		mg/kg	226	7440-50-8	
Lead	4.93	0.30		mg/kg	226	7439-92-1	
Selenium	Not detected	0.40		mg/kg	226	7782-49-2	
Silver	Not detected	0.20		mg/kg	226	7440-22-4	
Zinc	25.3	0.50		mg/kg	226	7440-66-6	

Method: SW7471B, Run Date: 05/24/24 15:30, Analyst: CTV

Parameter	Result	RL	MDL	Units	Dilution	CAS#	Flags
Mercury	Not detected	0.050		mg/kg	58	7439-97-6	

### Organics - PCBs/Pesticides

PCB List, Method: SW8082A, Run Date: 05/28/24 18:02, Analyst: JANB

Parameter	Result	RL	MDL	Units	Dilution	CAS#	Flags
PCB-1016	Not detected	330		ug/kg	5	12674-11-2	
PCB-1242	Not detected	330		ug/kg	5	53469-21-9	
PCB-1221	Not detected	330		ug/kg	5	11104-28-2	
PCB-1232	Not detected	330		ug/kg	5	11141-16-5	
PCB-1248	Not detected	330		ug/kg	5	12672-29-6	
PCB-1254	Not detected	330		ug/kg	5	11097-69-1	
PCB-1260	Not detected	330		ug/kg	5	11096-82-5	



# Analytical Laboratory Report

Lab Sample ID: S62474.06 (continued)

Sample Tag: SB-3 (10-11')

## Organics - Semi-Volatiles

Polynuclear Aromatics, Method: SW8270D, Run Date: 05/31/24 19:00, Analyst: PL

Parameter	Result	RL	MDL	Units	Dilution	CAS#	Flags
Acenaphthene	Not detected	300		ug/kg	10	83-32-9	
Acenaphthylene	Not detected	300		ug/kg	10	208-96-8	
Anthracene	Not detected	300		ug/kg	10	120-12-7	
Benzo(a)anthracene	Not detected	300		ug/kg	10	56-55-3	
Benzo(a)pyrene	Not detected	300		ug/kg	10	50-32-8	
Benzo(b)fluoranthene	Not detected	300		ug/kg	10	205-99-2	
Benzo(k)fluoranthene	Not detected	300		ug/kg	10	207-08-9	
Benzo(ghi)perylene	Not detected	300		ug/kg	10	191-24-2	
Chrysene	Not detected	300		ug/kg	10	218-01-9	
Dibenzo(ah)anthracene	Not detected	300		ug/kg	10	53-70-3	
Fluoranthene	Not detected	300		ug/kg	10	206-44-0	
Fluorene	Not detected	300		ug/kg	10	86-73-7	
Indeno(1,2,3-cd)pyrene	Not detected	300		ug/kg	10	193-39-5	
Naphthalene	Not detected	300		ug/kg	10	91-20-3	
Phenanthrene	Not detected	300		ug/kg	10	85-01-8	
Pyrene	Not detected	300		ug/kg	10	129-00-0	
2-Methylnaphthalene	Not detected	300		ug/kg	10	91-57-6	
1-Methylnaphthalene	Not detected	300		ug/kg	10	90-12-0	

## Organics

28 PFAs, Method: ASTM D7968-17M, Run Date: 05/29/24 18:28, Analyst: KCV

Parameter	Result	RL	MDL	Units	Dilution	CAS#	Flags
PFBA*	Not detected	87		ng/kg	4.36	375-22-4	
PFPeA*	Not detected	44		ng/kg	4.36	2706-90-3	
4:2 FTSA*	Not detected	44		ng/kg	4.36	757124-72-4	
PFHxA*	Not detected	44		ng/kg	4.36	307-24-4	
PFBS*	Not detected	44		ng/kg	4.36	375-73-5	
PFHpA*	Not detected	44		ng/kg	4.36	375-85-9	
PFPeS*	Not detected	44		ng/kg	4.36	2706-91-4	
6:2 FTSA*	Not detected	44		ng/kg	4.36	27619-97-2	
PFOA*	Not detected	44		ng/kg	4.36	335-67-1	
PFHxS*	Not detected	44		ng/kg	4.36	355-46-4	
PFHxS-LN*	Not detected	44		ng/kg	4.36	355-46-4-LN	
PFHxS-BR*	Not detected	44		ng/kg	4.36	355-46-4-BR	
PFNA*	Not detected	44		ng/kg	4.36	375-95-1	
8:2 FTSA*	Not detected	44		ng/kg	4.36	39108-34-4	
PFHpS*	Not detected	44		ng/kg	4.36	375-92-8	
PFDA*	Not detected	44		ng/kg	4.36	335-76-2	
N-MeFOSAA*	Not detected	44		ng/kg	4.36	2355-31-9	
EtFOSAA*	Not detected	44		ng/kg	4.36	2991-50-6	
PFOS*	Not detected	44		ng/kg	4.36	1763-23-1	
PFOS-LN*	Not detected	44		ng/kg	4.36	1763-23-1-LN	
PFOS-BR*	Not detected	44		ng/kg	4.36	1763-23-1-BR	
PFUnDA*	Not detected	44		ng/kg	4.36	2058-94-8	
PFNS*	Not detected	44		ng/kg	4.36	68259-12-1	
PFDODA*	Not detected	44		ng/kg	4.36	307-55-1	
PFDS*	Not detected	44		ng/kg	4.36	335-77-3	
PFTTrDA*	Not detected	44		ng/kg	4.36	72629-94-8	
FOSA*	Not detected	44		ng/kg	4.36	754-91-6	



# Analytical Laboratory Report

Lab Sample ID: S62474.06 (continued)

Sample Tag: SB-3 (10-11')

**28 PFAs, Method: ASTM D7968-17M, Run Date: 05/29/24 18:28, Analyst: KCV (continued)**

Parameter	Result	RL	MDL	Units	Dilution	CAS#	Flags
PFTeDA*	Not detected	44		ng/kg	4.36	376-06-7	
11Cl-PF3OUdS*	Not detected	44		ng/kg	4.36	763051-92-9	
9Cl-PF3ONS*	Not detected	44		ng/kg	4.36	756426-58-1	
ADONA*	Not detected	44		ng/kg	4.36	919005-14-4	
HFPO-DA*	Not detected	44		ng/kg	4.36	13252-13-6	

**Volatile Organics 5035, Method: SW5035A/8260C, Run Date: 05/25/24 17:02, Analyst: KAG**

Parameter	Result	RL	MDL	Units	Dilution	CAS#	Flags
Diethyl ether	Not detected	200		ug/kg	55.3	60-29-7	
Acetone	Not detected	1,000		ug/kg	55.3	67-64-1	
Methyl iodide	Not detected	100		ug/kg	55.3	74-88-4	
Carbon disulfide	Not detected	300		ug/kg	55.3	75-15-0	
tert-Methyl butyl ether (MTBE)	Not detected	200		ug/kg	55.3	1634-04-4	
Acrylonitrile	Not detected	100		ug/kg	55.3	107-13-1	
2-Butanone (MEK)	Not detected	830		ug/kg	55.3	78-93-3	
Dichlorodifluoromethane	Not detected	300		ug/kg	55.3	75-71-8	
Chloromethane	Not detected	300		ug/kg	55.3	74-87-3	
Vinyl chloride	Not detected	60		ug/kg	55.3	75-01-4	
Bromomethane	Not detected	200		ug/kg	55.3	74-83-9	
Chloroethane	Not detected	300		ug/kg	55.3	75-00-3	
Trichlorofluoromethane	Not detected	100		ug/kg	55.3	75-69-4	
1,1-Dichloroethene	Not detected	60		ug/kg	55.3	75-35-4	
Methylene chloride	Not detected	100		ug/kg	55.3	75-09-2	
trans-1,2-Dichloroethene	Not detected	60		ug/kg	55.3	156-60-5	
1,1-Dichloroethane	Not detected	60		ug/kg	55.3	75-34-3	
cis-1,2-Dichloroethene	Not detected	60		ug/kg	55.3	156-59-2	
Tetrahydrofuran*	Not detected	1,000		ug/kg	55.3	109-99-9	
Chloroform	Not detected	60		ug/kg	55.3	67-66-3	
Bromochloromethane	Not detected	100		ug/kg	55.3	74-97-5	
1,1,1-Trichloroethane	Not detected	60		ug/kg	55.3	71-55-6	
4-Methyl-2-pentanone (MIBK)	Not detected	3,000		ug/kg	55.3	108-10-1	
2-Hexanone	Not detected	3,000		ug/kg	55.3	591-78-6	
Carbon tetrachloride	Not detected	60		ug/kg	55.3	56-23-5	
Benzene	Not detected	60		ug/kg	55.3	71-43-2	
1,2-Dichloroethane	Not detected	60		ug/kg	55.3	107-06-2	
Trichloroethene	Not detected	60		ug/kg	55.3	79-01-6	
1,2-Dichloropropane	Not detected	60		ug/kg	55.3	78-87-5	
Bromodichloromethane	Not detected	100		ug/kg	55.3	75-27-4	
Dibromomethane	Not detected	300		ug/kg	55.3	74-95-3	
cis-1,3-Dichloropropene	Not detected	60		ug/kg	55.3	10061-01-5	
Toluene	Not detected	60		ug/kg	55.3	108-88-3	
trans-1,3-Dichloropropene	Not detected	60		ug/kg	55.3	10061-02-6	
1,1,2-Trichloroethane	Not detected	60		ug/kg	55.3	79-00-5	
Tetrachloroethene	Not detected	60		ug/kg	55.3	127-18-4	
trans-1,4-Dichloro-2-butene	Not detected	60		ug/kg	55.3	110-57-6	
Dibromochloromethane	Not detected	100		ug/kg	55.3	124-48-1	
1,2-Dibromoethane	Not detected	20		ug/kg	55.3	106-93-4	M
Chlorobenzene	Not detected	60		ug/kg	55.3	108-90-7	
1,1,1,2-Tetrachloroethane	Not detected	100		ug/kg	55.3	630-20-6	

M-Result reported to MDL not RDL





# Analytical Laboratory Report

Lab Sample ID: S62474.06 (continued)

Sample Tag: SB-3 (10-11')

**Volatile Organics 5035, Method: SW5035A/8260C, Run Date: 05/25/24 17:02, Analyst: KAG (continued)**

Parameter	Result	RL	MDL	Units	Dilution	CAS#	Flags
Ethylbenzene	Not detected	60		ug/kg	55.3	100-41-4	
p,m-Xylene	Not detected	100		ug/kg	55.3		
o-Xylene	Not detected	60		ug/kg	55.3	95-47-6	
Styrene	Not detected	60		ug/kg	55.3	100-42-5	
Isopropylbenzene	Not detected	300		ug/kg	55.3	98-82-8	
Bromoform	Not detected	100		ug/kg	55.3	75-25-2	
1,1,2,2-Tetrachloroethane	Not detected	60		ug/kg	55.3	79-34-5	
1,2,3-Trichloropropane	Not detected	100		ug/kg	55.3	96-18-4	
n-Propylbenzene	Not detected	60		ug/kg	55.3	103-65-1	
Bromobenzene	Not detected	100		ug/kg	55.3	108-86-1	
1,3,5-Trimethylbenzene	Not detected	60		ug/kg	55.3	108-67-8	
tert-Butylbenzene	Not detected	60		ug/kg	55.3	98-06-6	
1,2,4-Trimethylbenzene	Not detected	60		ug/kg	55.3	95-63-6	
sec-Butylbenzene	Not detected	60		ug/kg	55.3	135-98-8	
p-Isopropyltoluene	Not detected	100		ug/kg	55.3	99-87-6	
1,3-Dichlorobenzene	Not detected	100		ug/kg	55.3	541-73-1	
1,4-Dichlorobenzene	Not detected	100		ug/kg	55.3	106-46-7	
1,2-Dichlorobenzene	Not detected	100		ug/kg	55.3	95-50-1	
1,2,3-Trimethylbenzene	Not detected	60		ug/kg	55.3	526-73-8	
n-Butylbenzene	Not detected	60		ug/kg	55.3	104-51-8	
Hexachloroethane	Not detected	300		ug/kg	55.3	67-72-1	
1,2-Dibromo-3-chloropropane	Not detected	300		ug/kg	55.3	96-12-8	
1,2,4-Trichlorobenzene	Not detected	360		ug/kg	55.3	120-82-1	
1,2,3-Trichlorobenzene	Not detected	360		ug/kg	55.3	87-61-6	
Naphthalene	Not detected	300		ug/kg	55.3	91-20-3	
2-Methylnaphthalene	Not detected	100		ug/kg	55.3	91-57-6	



# Analytical Laboratory Report

Lab Sample ID: S62474.07

Sample Tag: SB-4 (1.5-2.5')

Collected Date/Time: 05/22/2024 13:00

Matrix: Soil

COC Reference: 171234

### Sample Containers

#	Type	Preservative(s)	Refrigerated?	Arrival Temp. (C)	Thermometer #
1	4oz Glass	None	Yes	6.0	IR
1	125mL Plastic	None	Yes	6.0	IR
1	40mL Glass	MeOH	Yes	6.0	IR
1	15mL Centrifuge Tube	None	Yes	6.0	IR

### Extraction / Prep.

Parameter	Result	Method	Run Date	Analyst	Flags
Initial wt. (g) / Final wt. (g) / Volume (ml)*	7.82/6.44/10	ASTM D7968-17M	05/29/24 10:00	SRP	
Metal Digestion	Completed	SW3050B	05/31/24 09:30	JRH	
Extraction, PCB*	Completed	SW3546	05/24/24 11:00	DJS	
PNA Extraction*	Completed	SW3546	05/30/24 15:00	DJS	
Sample wt. (g) / Methanol (ml)*	11.216/11	SW5035A	05/24/24 11:38	NDK	
Mercury Digestion	Completed	SW7471B	05/24/24 11:58	CTV	

### Inorganics

Method: SM2540B, Run Date: 05/28/24 12:48, Analyst: MAM

Parameter	Result	RL	MDL	Units	Dilution	CAS#	Flags
Total Solids*	94	1		%	1		

### Metals

Method: SW6020A, Run Date: 05/31/24 12:42, Analyst: JRH

Parameter	Result	RL	MDL	Units	Dilution	CAS#	Flags
Arsenic	12.4	0.20		mg/kg	227	7440-38-2	
Barium	41.7	1.0		mg/kg	227	7440-39-3	
Cadmium	Not detected	0.20		mg/kg	227	7440-43-9	
Chromium	12.5	0.50		mg/kg	227	7440-47-3	
Copper	15.4	0.50		mg/kg	227	7440-50-8	
Lead	6.55	0.30		mg/kg	227	7439-92-1	
Selenium	Not detected	0.40		mg/kg	227	7782-49-2	
Silver	Not detected	0.20		mg/kg	227	7440-22-4	
Zinc	45.1	0.50		mg/kg	227	7440-66-6	

Method: SW7471B, Run Date: 05/24/24 15:33, Analyst: CTV

Parameter	Result	RL	MDL	Units	Dilution	CAS#	Flags
Mercury	Not detected	0.050		mg/kg	61	7439-97-6	

### Organics - PCBs/Pesticides

PCB List, Method: SW8082A, Run Date: 05/28/24 18:17, Analyst: JANB

Parameter	Result	RL	MDL	Units	Dilution	CAS#	Flags
PCB-1016	Not detected	330		ug/kg	5	12674-11-2	
PCB-1242	Not detected	330		ug/kg	5	53469-21-9	
PCB-1221	Not detected	330		ug/kg	5	11104-28-2	
PCB-1232	Not detected	330		ug/kg	5	11141-16-5	
PCB-1248	Not detected	330		ug/kg	5	12672-29-6	
PCB-1254	Not detected	330		ug/kg	5	11097-69-1	
PCB-1260	Not detected	330		ug/kg	5	11096-82-5	



# Analytical Laboratory Report

Lab Sample ID: S62474.07 (continued)

Sample Tag: SB-4 (1.5-2.5')

## Organics - Semi-Volatiles

Polynuclear Aromatics, Method: SW8270D, Run Date: 05/31/24 19:17, Analyst: PL

Parameter	Result	RL	MDL	Units	Dilution	CAS#	Flags
Acenaphthene	Not detected	300		ug/kg	10	83-32-9	
Acenaphthylene	Not detected	300		ug/kg	10	208-96-8	
Anthracene	Not detected	300		ug/kg	10	120-12-7	
Benzo(a)anthracene	Not detected	300		ug/kg	10	56-55-3	
Benzo(a)pyrene	Not detected	300		ug/kg	10	50-32-8	
Benzo(b)fluoranthene	Not detected	300		ug/kg	10	205-99-2	
Benzo(k)fluoranthene	Not detected	300		ug/kg	10	207-08-9	
Benzo(ghi)perylene	Not detected	300		ug/kg	10	191-24-2	
Chrysene	Not detected	300		ug/kg	10	218-01-9	
Dibenzo(ah)anthracene	Not detected	300		ug/kg	10	53-70-3	
Fluoranthene	Not detected	300		ug/kg	10	206-44-0	
Fluorene	Not detected	300		ug/kg	10	86-73-7	
Indeno(1,2,3-cd)pyrene	Not detected	300		ug/kg	10	193-39-5	
Naphthalene	Not detected	300		ug/kg	10	91-20-3	
Phenanthrene	Not detected	300		ug/kg	10	85-01-8	
Pyrene	Not detected	300		ug/kg	10	129-00-0	
2-Methylnaphthalene	Not detected	300		ug/kg	10	91-57-6	
1-Methylnaphthalene	Not detected	300		ug/kg	10	90-12-0	

## Organics

28 PFAs, Method: ASTM D7968-17M, Run Date: 05/29/24 18:48, Analyst: KCV

Parameter	Result	RL	MDL	Units	Dilution	CAS#	Flags
PFBA*	Not detected	150		ng/kg	7.71	375-22-4	
PFPeA*	Not detected	77		ng/kg	7.71	2706-90-3	
4:2 FTSA*	Not detected	77		ng/kg	7.71	757124-72-4	
PFHxA*	Not detected	77		ng/kg	7.71	307-24-4	
PFBS*	Not detected	77		ng/kg	7.71	375-73-5	
PFHpA*	Not detected	77		ng/kg	7.71	375-85-9	
PFPeS*	Not detected	77		ng/kg	7.71	2706-91-4	
6:2 FTSA*	Not detected	77		ng/kg	7.71	27619-97-2	
PFOA*	Not detected	77		ng/kg	7.71	335-67-1	
PFHxS*	Not detected	77		ng/kg	7.71	355-46-4	
PFHxS-LN*	Not detected	77		ng/kg	7.71	355-46-4-LN	
PFHxS-BR*	Not detected	77		ng/kg	7.71	355-46-4-BR	
PFNA*	Not detected	77		ng/kg	7.71	375-95-1	
8:2 FTSA*	Not detected	77		ng/kg	7.71	39108-34-4	
PFHpS*	Not detected	77		ng/kg	7.71	375-92-8	
PFDA*	Not detected	77		ng/kg	7.71	335-76-2	
N-MeFOSAA*	Not detected	77		ng/kg	7.71	2355-31-9	
EtFOSAA*	Not detected	77		ng/kg	7.71	2991-50-6	
PFOS*	Not detected	77		ng/kg	7.71	1763-23-1	
PFOS-LN*	Not detected	77		ng/kg	7.71	1763-23-1-LN	
PFOS-BR*	Not detected	77		ng/kg	7.71	1763-23-1-BR	
PFUnDA*	Not detected	77		ng/kg	7.71	2058-94-8	
PFNS*	Not detected	77		ng/kg	7.71	68259-12-1	
PFDODA*	Not detected	77		ng/kg	7.71	307-55-1	
PFDS*	Not detected	77		ng/kg	7.71	335-77-3	
PFTTrDA*	Not detected	77		ng/kg	7.71	72629-94-8	
FOSA*	Not detected	77		ng/kg	7.71	754-91-6	



# Analytical Laboratory Report

Lab Sample ID: S62474.07 (continued)

Sample Tag: SB-4 (1.5-2.5')

**28 PFAs, Method: ASTM D7968-17M, Run Date: 05/29/24 18:48, Analyst: KCV (continued)**

Parameter	Result	RL	MDL	Units	Dilution	CAS#	Flags
PFTeDA*	Not detected	77		ng/kg	7.71	376-06-7	
11Cl-PF3OUdS*	Not detected	77		ng/kg	7.71	763051-92-9	
9Cl-PF3ONS*	Not detected	77		ng/kg	7.71	756426-58-1	
ADONA*	Not detected	77		ng/kg	7.71	919005-14-4	
HFPO-DA*	Not detected	77		ng/kg	7.71	13252-13-6	

**Volatile Organics 5035, Method: SW5035A/8260C, Run Date: 05/25/24 17:26, Analyst: KAG**

Parameter	Result	RL	MDL	Units	Dilution	CAS#	Flags
Diethyl ether	Not detected	200		ug/kg	55.4	60-29-7	
Acetone	Not detected	1,000		ug/kg	55.4	67-64-1	
Methyl iodide	Not detected	100		ug/kg	55.4	74-88-4	
Carbon disulfide	Not detected	300		ug/kg	55.4	75-15-0	
tert-Methyl butyl ether (MTBE)	Not detected	200		ug/kg	55.4	1634-04-4	
Acrylonitrile	Not detected	100		ug/kg	55.4	107-13-1	
2-Butanone (MEK)	Not detected	830		ug/kg	55.4	78-93-3	
Dichlorodifluoromethane	Not detected	300		ug/kg	55.4	75-71-8	
Chloromethane	Not detected	300		ug/kg	55.4	74-87-3	
Vinyl chloride	Not detected	60		ug/kg	55.4	75-01-4	
Bromomethane	Not detected	200		ug/kg	55.4	74-83-9	
Chloroethane	Not detected	300		ug/kg	55.4	75-00-3	
Trichlorofluoromethane	Not detected	100		ug/kg	55.4	75-69-4	
1,1-Dichloroethene	Not detected	60		ug/kg	55.4	75-35-4	
Methylene chloride	Not detected	100		ug/kg	55.4	75-09-2	
trans-1,2-Dichloroethene	Not detected	60		ug/kg	55.4	156-60-5	
1,1-Dichloroethane	Not detected	60		ug/kg	55.4	75-34-3	
cis-1,2-Dichloroethene	Not detected	60		ug/kg	55.4	156-59-2	
Tetrahydrofuran*	Not detected	1,000		ug/kg	55.4	109-99-9	
Chloroform	Not detected	60		ug/kg	55.4	67-66-3	
Bromochloromethane	Not detected	100		ug/kg	55.4	74-97-5	
1,1,1-Trichloroethane	Not detected	60		ug/kg	55.4	71-55-6	
4-Methyl-2-pentanone (MIBK)	Not detected	3,000		ug/kg	55.4	108-10-1	
2-Hexanone	Not detected	3,000		ug/kg	55.4	591-78-6	
Carbon tetrachloride	Not detected	60		ug/kg	55.4	56-23-5	
Benzene	Not detected	60		ug/kg	55.4	71-43-2	
1,2-Dichloroethane	Not detected	60		ug/kg	55.4	107-06-2	
Trichloroethene	Not detected	60		ug/kg	55.4	79-01-6	
1,2-Dichloropropane	Not detected	60		ug/kg	55.4	78-87-5	
Bromodichloromethane	Not detected	100		ug/kg	55.4	75-27-4	
Dibromomethane	Not detected	300		ug/kg	55.4	74-95-3	
cis-1,3-Dichloropropene	Not detected	60		ug/kg	55.4	10061-01-5	
Toluene	Not detected	60		ug/kg	55.4	108-88-3	
trans-1,3-Dichloropropene	Not detected	60		ug/kg	55.4	10061-02-6	
1,1,2-Trichloroethane	Not detected	60		ug/kg	55.4	79-00-5	
Tetrachloroethene	Not detected	60		ug/kg	55.4	127-18-4	
trans-1,4-Dichloro-2-butene	Not detected	60		ug/kg	55.4	110-57-6	
Dibromochloromethane	Not detected	100		ug/kg	55.4	124-48-1	
1,2-Dibromoethane	Not detected	20		ug/kg	55.4	106-93-4	M
Chlorobenzene	Not detected	60		ug/kg	55.4	108-90-7	
1,1,1,2-Tetrachloroethane	Not detected	100		ug/kg	55.4	630-20-6	

M-Result reported to MDL not RDL



# Analytical Laboratory Report

Lab Sample ID: S62474.07 (continued)

Sample Tag: SB-4 (1.5-2.5')

**Volatile Organics 5035, Method: SW5035A/8260C, Run Date: 05/25/24 17:26, Analyst: KAG (continued)**

Parameter	Result	RL	MDL	Units	Dilution	CAS#	Flags
Ethylbenzene	Not detected	60		ug/kg	55.4	100-41-4	
p,m-Xylene	Not detected	100		ug/kg	55.4		
o-Xylene	Not detected	60		ug/kg	55.4	95-47-6	
Styrene	Not detected	60		ug/kg	55.4	100-42-5	
Isopropylbenzene	Not detected	300		ug/kg	55.4	98-82-8	
Bromoform	Not detected	100		ug/kg	55.4	75-25-2	
1,1,2,2-Tetrachloroethane	Not detected	60		ug/kg	55.4	79-34-5	
1,2,3-Trichloropropane	Not detected	100		ug/kg	55.4	96-18-4	
n-Propylbenzene	Not detected	60		ug/kg	55.4	103-65-1	
Bromobenzene	Not detected	100		ug/kg	55.4	108-86-1	
1,3,5-Trimethylbenzene	Not detected	60		ug/kg	55.4	108-67-8	
tert-Butylbenzene	Not detected	60		ug/kg	55.4	98-06-6	
1,2,4-Trimethylbenzene	Not detected	60		ug/kg	55.4	95-63-6	
sec-Butylbenzene	Not detected	60		ug/kg	55.4	135-98-8	
p-Isopropyltoluene	Not detected	100		ug/kg	55.4	99-87-6	
1,3-Dichlorobenzene	Not detected	100		ug/kg	55.4	541-73-1	
1,4-Dichlorobenzene	Not detected	100		ug/kg	55.4	106-46-7	
1,2-Dichlorobenzene	Not detected	100		ug/kg	55.4	95-50-1	
1,2,3-Trimethylbenzene	Not detected	60		ug/kg	55.4	526-73-8	
n-Butylbenzene	Not detected	60		ug/kg	55.4	104-51-8	
Hexachloroethane	Not detected	300		ug/kg	55.4	67-72-1	
1,2-Dibromo-3-chloropropane	Not detected	300		ug/kg	55.4	96-12-8	
1,2,4-Trichlorobenzene	Not detected	370		ug/kg	55.4	120-82-1	
1,2,3-Trichlorobenzene	Not detected	370		ug/kg	55.4	87-61-6	
Naphthalene	Not detected	300		ug/kg	55.4	91-20-3	
2-Methylnaphthalene	Not detected	100		ug/kg	55.4	91-57-6	



# Analytical Laboratory Report

Lab Sample ID: S62474.08

Sample Tag: SB-4 (10-11')

Collected Date/Time: 05/22/2024 13:05

Matrix: Soil

COC Reference: 171234

### Sample Containers

#	Type	Preservative(s)	Refrigerated?	Arrival Temp. (C)	Thermometer #
1	4oz Glass	None	Yes	6.0	IR
1	125mL Plastic	None	Yes	6.0	IR
1	40mL Glass	MeOH	Yes	6.0	IR
1	15mL Centrifuge Tube	None	Yes	6.0	IR

### Extraction / Prep.

Parameter	Result	Method	Run Date	Analyst	Flags
Initial wt. (g) / Final wt. (g) / Volume (ml)*	8.51/6.42/10	ASTM D7968-17M	05/29/24 10:00	SRP	
Metal Digestion	Completed	SW3050B	05/31/24 09:30	JRH	
Extraction, PCB*	Completed	SW3546	05/24/24 11:00	DJS	
PNA Extraction*	Completed	SW3546	06/03/24 14:15	JWR	
Sample wt. (g) / Methanol (ml)*	11.050/11	SW5035A	05/24/24 11:38	NDK	
Mercury Digestion	Completed	SW7471B	05/24/24 11:58	CTV	

### Inorganics

Method: SM2540B, Run Date: 05/28/24 12:48, Analyst: MAM

Parameter	Result	RL	MDL	Units	Dilution	CAS#	Flags
Total Solids*	83	1		%	1		

### Metals

Method: SW6020A, Run Date: 05/31/24 12:45, Analyst: JRH

Parameter	Result	RL	MDL	Units	Dilution	CAS#	Flags
Arsenic	2.98	0.20		mg/kg	262	7440-38-2	
Barium	6.92	1.0		mg/kg	262	7440-39-3	
Cadmium	Not detected	0.20		mg/kg	262	7440-43-9	
Chromium	3.94	0.50		mg/kg	262	7440-47-3	
Copper	4.49	0.50		mg/kg	262	7440-50-8	
Lead	2.17	0.30		mg/kg	262	7439-92-1	
Selenium	Not detected	0.40		mg/kg	262	7782-49-2	
Silver	Not detected	0.20		mg/kg	262	7440-22-4	
Zinc	16.8	0.50		mg/kg	262	7440-66-6	

Method: SW7471B, Run Date: 05/24/24 15:37, Analyst: CTV

Parameter	Result	RL	MDL	Units	Dilution	CAS#	Flags
Mercury	Not detected	0.050		mg/kg	70	7439-97-6	

### Organics - PCBs/Pesticides

PCB List, Method: SW8082A, Run Date: 05/28/24 18:31, Analyst: JANB

Parameter	Result	RL	MDL	Units	Dilution	CAS#	Flags
PCB-1016	Not detected	330		ug/kg	5	12674-11-2	
PCB-1242	Not detected	330		ug/kg	5	53469-21-9	
PCB-1221	Not detected	330		ug/kg	5	11104-28-2	
PCB-1232	Not detected	330		ug/kg	5	11141-16-5	
PCB-1248	Not detected	330		ug/kg	5	12672-29-6	
PCB-1254	Not detected	330		ug/kg	5	11097-69-1	
PCB-1260	Not detected	330		ug/kg	5	11096-82-5	



# Analytical Laboratory Report

Lab Sample ID: S62474.08 (continued)

Sample Tag: SB-4 (10-11')

## Organics - Semi-Volatiles

Polynuclear Aromatics, Method: SW8270D, Run Date: 06/04/24 15:09, Analyst: PL

Parameter	Result	RL	MDL	Units	Dilution	CAS#	Flags
Acenaphthene	Not detected	300		ug/kg	10	83-32-9	
Acenaphthylene	Not detected	300		ug/kg	10	208-96-8	
Anthracene	Not detected	300		ug/kg	10	120-12-7	
Benzo(a)anthracene	Not detected	300		ug/kg	10	56-55-3	
Benzo(a)pyrene	Not detected	300		ug/kg	10	50-32-8	
Benzo(b)fluoranthene	Not detected	300		ug/kg	10	205-99-2	
Benzo(k)fluoranthene	Not detected	300		ug/kg	10	207-08-9	
Benzo(ghi)perylene	Not detected	300		ug/kg	10	191-24-2	
Chrysene	Not detected	300		ug/kg	10	218-01-9	
Dibenzo(ah)anthracene	Not detected	300		ug/kg	10	53-70-3	
Fluoranthene	Not detected	300		ug/kg	10	206-44-0	
Fluorene	Not detected	300		ug/kg	10	86-73-7	
Indeno(1,2,3-cd)pyrene	Not detected	300		ug/kg	10	193-39-5	
Naphthalene	Not detected	300		ug/kg	10	91-20-3	
Phenanthrene	Not detected	300		ug/kg	10	85-01-8	
Pyrene	Not detected	300		ug/kg	10	129-00-0	
2-Methylnaphthalene	Not detected	300		ug/kg	10	91-57-6	
1-Methylnaphthalene	Not detected	300		ug/kg	10	90-12-0	

## Organics

28 PFAs, Method: ASTM D7968-17M, Run Date: 05/29/24 19:08, Analyst: KCV

Parameter	Result	RL	MDL	Units	Dilution	CAS#	Flags
PFBA*	Not detected	120		ng/kg	5.76	375-22-4	
PFPeA*	Not detected	58		ng/kg	5.76	2706-90-3	
4:2 FTSA*	Not detected	58		ng/kg	5.76	757124-72-4	
PFHxA*	Not detected	58		ng/kg	5.76	307-24-4	
PFBS*	Not detected	58		ng/kg	5.76	375-73-5	
PFHpA*	Not detected	58		ng/kg	5.76	375-85-9	
PFPeS*	Not detected	58		ng/kg	5.76	2706-91-4	
6:2 FTSA*	Not detected	58		ng/kg	5.76	27619-97-2	
PFOA*	Not detected	58		ng/kg	5.76	335-67-1	
PFHxS*	Not detected	58		ng/kg	5.76	355-46-4	
PFHxS-LN*	Not detected	58		ng/kg	5.76	355-46-4-LN	
PFHxS-BR*	Not detected	58		ng/kg	5.76	355-46-4-BR	
PFNA*	Not detected	58		ng/kg	5.76	375-95-1	
8:2 FTSA*	Not detected	58		ng/kg	5.76	39108-34-4	
PFHpS*	Not detected	58		ng/kg	5.76	375-92-8	
PFDA*	Not detected	58		ng/kg	5.76	335-76-2	
N-MeFOSAA*	Not detected	58		ng/kg	5.76	2355-31-9	
EtFOSAA*	Not detected	58		ng/kg	5.76	2991-50-6	
PFOS*	Not detected	58		ng/kg	5.76	1763-23-1	
PFOS-LN*	Not detected	58		ng/kg	5.76	1763-23-1-LN	
PFOS-BR*	Not detected	58		ng/kg	5.76	1763-23-1-BR	
PFUnDA*	Not detected	58		ng/kg	5.76	2058-94-8	
PFNS*	Not detected	58		ng/kg	5.76	68259-12-1	
PFDODA*	Not detected	58		ng/kg	5.76	307-55-1	
PFDS*	Not detected	58		ng/kg	5.76	335-77-3	
PFTTrDA*	Not detected	58		ng/kg	5.76	72629-94-8	
FOSA*	Not detected	58		ng/kg	5.76	754-91-6	



# Analytical Laboratory Report

Lab Sample ID: S62474.08 (continued)

Sample Tag: SB-4 (10-11')

**28 PFAs, Method: ASTM D7968-17M, Run Date: 05/29/24 19:08, Analyst: KCV (continued)**

Parameter	Result	RL	MDL	Units	Dilution	CAS#	Flags
PFTeDA*	Not detected	58		ng/kg	5.76	376-06-7	
11Cl-PF3OUdS*	Not detected	58		ng/kg	5.76	763051-92-9	
9Cl-PF3ONS*	Not detected	58		ng/kg	5.76	756426-58-1	
ADONA*	Not detected	58		ng/kg	5.76	919005-14-4	
HFPO-DA*	Not detected	58		ng/kg	5.76	13252-13-6	

**Volatile Organics 5035, Method: SW5035A/8260C, Run Date: 05/25/24 17:50, Analyst: KAG**

Parameter	Result	RL	MDL	Units	Dilution	CAS#	Flags
Diethyl ether	Not detected	300		ug/kg	70.2	60-29-7	
Acetone	Not detected	1,000		ug/kg	70.2	67-64-1	
Methyl iodide	Not detected	100		ug/kg	70.2	74-88-4	
Carbon disulfide	Not detected	400		ug/kg	70.2	75-15-0	
tert-Methyl butyl ether (MTBE)	Not detected	300		ug/kg	70.2	1634-04-4	
Acrylonitrile	Not detected	100		ug/kg	70.2	107-13-1	
2-Butanone (MEK)	Not detected	1,100		ug/kg	70.2	78-93-3	
Dichlorodifluoromethane	Not detected	400		ug/kg	70.2	75-71-8	
Chloromethane	Not detected	400		ug/kg	70.2	74-87-3	
Vinyl chloride	Not detected	70		ug/kg	70.2	75-01-4	
Bromomethane	Not detected	300		ug/kg	70.2	74-83-9	
Chloroethane	Not detected	400		ug/kg	70.2	75-00-3	
Trichlorofluoromethane	Not detected	100		ug/kg	70.2	75-69-4	
1,1-Dichloroethene	Not detected	70		ug/kg	70.2	75-35-4	
Methylene chloride	Not detected	100		ug/kg	70.2	75-09-2	
trans-1,2-Dichloroethene	Not detected	70		ug/kg	70.2	156-60-5	
1,1-Dichloroethane	Not detected	70		ug/kg	70.2	75-34-3	
cis-1,2-Dichloroethene	Not detected	70		ug/kg	70.2	156-59-2	
Tetrahydrofuran*	Not detected	1,000		ug/kg	70.2	109-99-9	
Chloroform	Not detected	70		ug/kg	70.2	67-66-3	
Bromochloromethane	Not detected	100		ug/kg	70.2	74-97-5	
1,1,1-Trichloroethane	Not detected	70		ug/kg	70.2	71-55-6	
4-Methyl-2-pentanone (MIBK)	Not detected	4,000		ug/kg	70.2	108-10-1	
2-Hexanone	Not detected	4,000		ug/kg	70.2	591-78-6	
Carbon tetrachloride	Not detected	70		ug/kg	70.2	56-23-5	
Benzene	Not detected	70		ug/kg	70.2	71-43-2	
1,2-Dichloroethane	Not detected	70		ug/kg	70.2	107-06-2	
Trichloroethene	Not detected	70		ug/kg	70.2	79-01-6	
1,2-Dichloropropane	Not detected	70		ug/kg	70.2	78-87-5	
Bromodichloromethane	Not detected	100		ug/kg	70.2	75-27-4	
Dibromomethane	Not detected	400		ug/kg	70.2	74-95-3	
cis-1,3-Dichloropropene	Not detected	70		ug/kg	70.2	10061-01-5	
Toluene	Not detected	70		ug/kg	70.2	108-88-3	
trans-1,3-Dichloropropene	Not detected	70		ug/kg	70.2	10061-02-6	
1,1,2-Trichloroethane	Not detected	70		ug/kg	70.2	79-00-5	
Tetrachloroethene	Not detected	70		ug/kg	70.2	127-18-4	
trans-1,4-Dichloro-2-butene	Not detected	70		ug/kg	70.2	110-57-6	
Dibromochloromethane	Not detected	100		ug/kg	70.2	124-48-1	
1,2-Dibromoethane	Not detected	30		ug/kg	70.2	106-93-4	M
Chlorobenzene	Not detected	70		ug/kg	70.2	108-90-7	
1,1,1,2-Tetrachloroethane	Not detected	100		ug/kg	70.2	630-20-6	

M-Result reported to MDL not RDL





# Analytical Laboratory Report

Lab Sample ID: S62474.08 (continued)

Sample Tag: SB-4 (10-11')

**Volatile Organics 5035, Method: SW5035A/8260C, Run Date: 05/25/24 17:50, Analyst: KAG (continued)**

Parameter	Result	RL	MDL	Units	Dilution	CAS#	Flags
Ethylbenzene	Not detected	70		ug/kg	70.2	100-41-4	
p,m-Xylene	Not detected	100		ug/kg	70.2		
o-Xylene	Not detected	70		ug/kg	70.2	95-47-6	
Styrene	Not detected	70		ug/kg	70.2	100-42-5	
Isopropylbenzene	Not detected	400		ug/kg	70.2	98-82-8	
Bromoform	Not detected	100		ug/kg	70.2	75-25-2	
1,1,2,2-Tetrachloroethane	Not detected	70		ug/kg	70.2	79-34-5	
1,2,3-Trichloropropane	Not detected	100		ug/kg	70.2	96-18-4	
n-Propylbenzene	Not detected	70		ug/kg	70.2	103-65-1	
Bromobenzene	Not detected	100		ug/kg	70.2	108-86-1	
1,3,5-Trimethylbenzene	Not detected	70		ug/kg	70.2	108-67-8	
tert-Butylbenzene	Not detected	70		ug/kg	70.2	98-06-6	
1,2,4-Trimethylbenzene	Not detected	70		ug/kg	70.2	95-63-6	
sec-Butylbenzene	Not detected	70		ug/kg	70.2	135-98-8	
p-Isopropyltoluene	Not detected	100		ug/kg	70.2	99-87-6	
1,3-Dichlorobenzene	Not detected	100		ug/kg	70.2	541-73-1	
1,4-Dichlorobenzene	Not detected	100		ug/kg	70.2	106-46-7	
1,2-Dichlorobenzene	Not detected	100		ug/kg	70.2	95-50-1	
1,2,3-Trimethylbenzene	Not detected	70		ug/kg	70.2	526-73-8	
n-Butylbenzene	Not detected	70		ug/kg	70.2	104-51-8	
Hexachloroethane	Not detected	400		ug/kg	70.2	67-72-1	
1,2-Dibromo-3-chloropropane	Not detected	400		ug/kg	70.2	96-12-8	
1,2,4-Trichlorobenzene	Not detected	460		ug/kg	70.2	120-82-1	
1,2,3-Trichlorobenzene	Not detected	460		ug/kg	70.2	87-61-6	
Naphthalene	Not detected	400		ug/kg	70.2	91-20-3	
2-Methylnaphthalene	Not detected	100		ug/kg	70.2	91-57-6	



# Analytical Laboratory Report

Lab Sample ID: S62474.09

Sample Tag: DUP-1S

Collected Date/Time: 05/22/2024 00:01

Matrix: Soil

COC Reference: 171234

### Sample Containers

#	Type	Preservative(s)	Refrigerated?	Arrival Temp. (C)	Thermometer #
1	4oz Glass	None	Yes	6.0	IR
1	125mL Plastic	None	Yes	6.0	IR
1	40mL Glass	MeOH	Yes	6.0	IR
1	15mL Centrifuge Tube	None	Yes	6.0	IR

### Extraction / Prep.

Parameter	Result	Method	Run Date	Analyst	Flags
Initial wt. (g) / Final wt. (g) / Volume (ml)*	9.48/6.42/10	ASTM D7968-17M	05/29/24 10:00	SRP	
Metal Digestion	Completed	SW3050B	05/31/24 09:30	JRH	
Extraction, PCB*	Completed	SW3546	05/24/24 11:00	DJS	
PNA Extraction*	Completed	SW3546	06/03/24 14:15	JWR	
Sample wt. (g) / Methanol (ml)*	10.905/10	SW5035A	05/24/24 11:38	NDK	
Mercury Digestion	Completed	SW7471B	05/24/24 11:58	CTV	

### Inorganics

Method: SM2540B, Run Date: 05/28/24 12:48, Analyst: MAM

Parameter	Result	RL	MDL	Units	Dilution	CAS#	Flags
Total Solids*	84	1		%	1		

### Metals

Method: SW6020A, Run Date: 05/31/24 12:48, Analyst: JRH

Parameter	Result	RL	MDL	Units	Dilution	CAS#	Flags
Arsenic	2.69	0.20		mg/kg	255	7440-38-2	
Barium	6.42	1.0		mg/kg	255	7440-39-3	
Cadmium	Not detected	0.20		mg/kg	255	7440-43-9	
Chromium	3.25	0.50		mg/kg	255	7440-47-3	
Copper	4.28	0.50		mg/kg	255	7440-50-8	
Lead	1.97	0.30		mg/kg	255	7439-92-1	
Selenium	Not detected	0.40		mg/kg	255	7782-49-2	
Silver	Not detected	0.20		mg/kg	255	7440-22-4	
Zinc	15.7	0.50		mg/kg	255	7440-66-6	

Method: SW7471B, Run Date: 05/24/24 15:40, Analyst: CTV

Parameter	Result	RL	MDL	Units	Dilution	CAS#	Flags
Mercury	Not detected	0.050		mg/kg	70	7439-97-6	

### Organics - PCBs/Pesticides

PCB List, Method: SW8082A, Run Date: 05/28/24 11:00, Analyst: JANB

Parameter	Result	RL	MDL	Units	Dilution	CAS#	Flags
PCB-1016	Not detected	330		ug/kg	1	12674-11-2	
PCB-1242	Not detected	330		ug/kg	1	53469-21-9	
PCB-1221	Not detected	330		ug/kg	1	11104-28-2	
PCB-1232	Not detected	330		ug/kg	1	11141-16-5	
PCB-1248	Not detected	330		ug/kg	1	12672-29-6	
PCB-1254	Not detected	330		ug/kg	1	11097-69-1	
PCB-1260	Not detected	330		ug/kg	1	11096-82-5	



# Analytical Laboratory Report

Lab Sample ID: S62474.09 (continued)

Sample Tag: DUP-1S

## Organics - Semi-Volatiles

Polynuclear Aromatics, Method: SW8270D, Run Date: 06/04/24 16:00, Analyst: PL

Parameter	Result	RL	MDL	Units	Dilution	CAS#	Flags
Acenaphthene	Not detected	300		ug/kg	10	83-32-9	
Acenaphthylene	Not detected	300		ug/kg	10	208-96-8	
Anthracene	Not detected	300		ug/kg	10	120-12-7	
Benzo(a)anthracene	Not detected	300		ug/kg	10	56-55-3	
Benzo(a)pyrene	Not detected	300		ug/kg	10	50-32-8	
Benzo(b)fluoranthene	Not detected	300		ug/kg	10	205-99-2	
Benzo(k)fluoranthene	Not detected	300		ug/kg	10	207-08-9	
Benzo(ghi)perylene	Not detected	300		ug/kg	10	191-24-2	
Chrysene	Not detected	300		ug/kg	10	218-01-9	
Dibenzo(ah)anthracene	Not detected	300		ug/kg	10	53-70-3	
Fluoranthene	Not detected	300		ug/kg	10	206-44-0	
Fluorene	Not detected	300		ug/kg	10	86-73-7	
Indeno(1,2,3-cd)pyrene	Not detected	300		ug/kg	10	193-39-5	
Naphthalene	Not detected	300		ug/kg	10	91-20-3	
Phenanthrene	Not detected	300		ug/kg	10	85-01-8	
Pyrene	Not detected	300		ug/kg	10	129-00-0	
2-Methylnaphthalene	Not detected	300		ug/kg	10	91-57-6	
1-Methylnaphthalene	Not detected	300		ug/kg	10	90-12-0	

## Organics

28 PFAs, Method: ASTM D7968-17M, Run Date: 05/29/24 19:28, Analyst: KCV

Parameter	Result	RL	MDL	Units	Dilution	CAS#	Flags
PFBA*	Not detected	78		ng/kg	3.89	375-22-4	
PFPeA*	Not detected	39		ng/kg	3.89	2706-90-3	
4:2 FTSA*	Not detected	39		ng/kg	3.89	757124-72-4	
PFHxA*	Not detected	39		ng/kg	3.89	307-24-4	
PFBS*	Not detected	39		ng/kg	3.89	375-73-5	
PFHpA*	Not detected	39		ng/kg	3.89	375-85-9	
PFPeS*	Not detected	39		ng/kg	3.89	2706-91-4	
6:2 FTSA*	Not detected	39		ng/kg	3.89	27619-97-2	
PFOA*	Not detected	39		ng/kg	3.89	335-67-1	
PFHxS*	Not detected	39		ng/kg	3.89	355-46-4	
PFHxS-LN*	Not detected	39		ng/kg	3.89	355-46-4-LN	
PFHxS-BR*	Not detected	39		ng/kg	3.89	355-46-4-BR	
PFNA*	Not detected	39		ng/kg	3.89	375-95-1	
8:2 FTSA*	Not detected	39		ng/kg	3.89	39108-34-4	
PFHpS*	Not detected	39		ng/kg	3.89	375-92-8	
PFDA*	Not detected	39		ng/kg	3.89	335-76-2	
N-MeFOSAA*	Not detected	39		ng/kg	3.89	2355-31-9	
EtFOSAA*	Not detected	39		ng/kg	3.89	2991-50-6	
PFOS*	Not detected	39		ng/kg	3.89	1763-23-1	
PFOS-LN*	Not detected	39		ng/kg	3.89	1763-23-1-LN	
PFOS-BR*	Not detected	39		ng/kg	3.89	1763-23-1-BR	
PFUnDA*	Not detected	39		ng/kg	3.89	2058-94-8	
PFNS*	Not detected	39		ng/kg	3.89	68259-12-1	
PFDODA*	Not detected	39		ng/kg	3.89	307-55-1	
PFDS*	Not detected	39		ng/kg	3.89	335-77-3	
PFTTrDA*	Not detected	39		ng/kg	3.89	72629-94-8	
FOSA*	Not detected	39		ng/kg	3.89	754-91-6	



# Analytical Laboratory Report

Lab Sample ID: S62474.09 (continued)

Sample Tag: DUP-1S

**28 PFAs, Method: ASTM D7968-17M, Run Date: 05/29/24 19:28, Analyst: KCV (continued)**

Parameter	Result	RL	MDL	Units	Dilution	CAS#	Flags
PFTeDA*	Not detected	39		ng/kg	3.89	376-06-7	
11Cl-PF3OUdS*	Not detected	39		ng/kg	3.89	763051-92-9	
9Cl-PF3ONS*	Not detected	39		ng/kg	3.89	756426-58-1	
ADONA*	Not detected	39		ng/kg	3.89	919005-14-4	
HFPO-DA*	Not detected	39		ng/kg	3.89	13252-13-6	

**Volatile Organics 5035, Method: SW5035A/8260C, Run Date: 05/25/24 18:14, Analyst: KAG**

Parameter	Result	RL	MDL	Units	Dilution	CAS#	Flags
Diethyl ether	Not detected	300		ug/kg	64.1	60-29-7	
Acetone	Not detected	1,000		ug/kg	64.1	67-64-1	
Methyl iodide	Not detected	100		ug/kg	64.1	74-88-4	
Carbon disulfide	Not detected	300		ug/kg	64.1	75-15-0	
tert-Methyl butyl ether (MTBE)	Not detected	300		ug/kg	64.1	1634-04-4	
Acrylonitrile	Not detected	100		ug/kg	64.1	107-13-1	
2-Butanone (MEK)	Not detected	960		ug/kg	64.1	78-93-3	
Dichlorodifluoromethane	Not detected	300		ug/kg	64.1	75-71-8	
Chloromethane	Not detected	300		ug/kg	64.1	74-87-3	
Vinyl chloride	Not detected	60		ug/kg	64.1	75-01-4	
Bromomethane	Not detected	300		ug/kg	64.1	74-83-9	
Chloroethane	Not detected	300		ug/kg	64.1	75-00-3	
Trichlorofluoromethane	Not detected	100		ug/kg	64.1	75-69-4	
1,1-Dichloroethene	Not detected	60		ug/kg	64.1	75-35-4	
Methylene chloride	Not detected	100		ug/kg	64.1	75-09-2	
trans-1,2-Dichloroethene	Not detected	60		ug/kg	64.1	156-60-5	
1,1-Dichloroethane	Not detected	60		ug/kg	64.1	75-34-3	
cis-1,2-Dichloroethene	Not detected	60		ug/kg	64.1	156-59-2	
Tetrahydrofuran*	Not detected	1,000		ug/kg	64.1	109-99-9	
Chloroform	Not detected	60		ug/kg	64.1	67-66-3	
Bromochloromethane	Not detected	100		ug/kg	64.1	74-97-5	
1,1,1-Trichloroethane	Not detected	60		ug/kg	64.1	71-55-6	
4-Methyl-2-pentanone (MIBK)	Not detected	3,000		ug/kg	64.1	108-10-1	
2-Hexanone	Not detected	3,000		ug/kg	64.1	591-78-6	
Carbon tetrachloride	Not detected	60		ug/kg	64.1	56-23-5	
Benzene	Not detected	60		ug/kg	64.1	71-43-2	
1,2-Dichloroethane	Not detected	60		ug/kg	64.1	107-06-2	
Trichloroethene	Not detected	60		ug/kg	64.1	79-01-6	
1,2-Dichloropropane	Not detected	60		ug/kg	64.1	78-87-5	
Bromodichloromethane	Not detected	100		ug/kg	64.1	75-27-4	
Dibromomethane	Not detected	300		ug/kg	64.1	74-95-3	
cis-1,3-Dichloropropene	Not detected	60		ug/kg	64.1	10061-01-5	
Toluene	Not detected	60		ug/kg	64.1	108-88-3	
trans-1,3-Dichloropropene	Not detected	60		ug/kg	64.1	10061-02-6	
1,1,2-Trichloroethane	Not detected	60		ug/kg	64.1	79-00-5	
Tetrachloroethene	Not detected	60		ug/kg	64.1	127-18-4	
trans-1,4-Dichloro-2-butene	Not detected	60		ug/kg	64.1	110-57-6	
Dibromochloromethane	Not detected	100		ug/kg	64.1	124-48-1	
1,2-Dibromoethane	Not detected	30		ug/kg	64.1	106-93-4	M
Chlorobenzene	Not detected	60		ug/kg	64.1	108-90-7	
1,1,1,2-Tetrachloroethane	Not detected	100		ug/kg	64.1	630-20-6	

M-Result reported to MDL not RDL



# Analytical Laboratory Report

Lab Sample ID: S62474.09 (continued)

Sample Tag: DUP-1S

**Volatile Organics 5035, Method: SW5035A/8260C, Run Date: 05/25/24 18:14, Analyst: KAG (continued)**

Parameter	Result	RL	MDL	Units	Dilution	CAS#	Flags
Ethylbenzene	Not detected	60		ug/kg	64.1	100-41-4	
p,m-Xylene	Not detected	100		ug/kg	64.1		
o-Xylene	Not detected	60		ug/kg	64.1	95-47-6	
Styrene	Not detected	60		ug/kg	64.1	100-42-5	
Isopropylbenzene	Not detected	300		ug/kg	64.1	98-82-8	
Bromoform	Not detected	100		ug/kg	64.1	75-25-2	
1,1,2,2-Tetrachloroethane	Not detected	60		ug/kg	64.1	79-34-5	
1,2,3-Trichloropropane	Not detected	100		ug/kg	64.1	96-18-4	
n-Propylbenzene	Not detected	60		ug/kg	64.1	103-65-1	
Bromobenzene	Not detected	100		ug/kg	64.1	108-86-1	
1,3,5-Trimethylbenzene	Not detected	60		ug/kg	64.1	108-67-8	
tert-Butylbenzene	Not detected	60		ug/kg	64.1	98-06-6	
1,2,4-Trimethylbenzene	Not detected	60		ug/kg	64.1	95-63-6	
sec-Butylbenzene	Not detected	60		ug/kg	64.1	135-98-8	
p-Isopropyltoluene	Not detected	100		ug/kg	64.1	99-87-6	
1,3-Dichlorobenzene	Not detected	100		ug/kg	64.1	541-73-1	
1,4-Dichlorobenzene	Not detected	100		ug/kg	64.1	106-46-7	
1,2-Dichlorobenzene	Not detected	100		ug/kg	64.1	95-50-1	
1,2,3-Trimethylbenzene	Not detected	60		ug/kg	64.1	526-73-8	
n-Butylbenzene	Not detected	60		ug/kg	64.1	104-51-8	
Hexachloroethane	Not detected	400		ug/kg	64.1	67-72-1	
1,2-Dibromo-3-chloropropane	Not detected	300		ug/kg	64.1	96-12-8	
1,2,4-Trichlorobenzene	Not detected	420		ug/kg	64.1	120-82-1	
1,2,3-Trichlorobenzene	Not detected	420		ug/kg	64.1	87-61-6	
Naphthalene	Not detected	300		ug/kg	64.1	91-20-3	
2-Methylnaphthalene	Not detected	100		ug/kg	64.1	91-57-6	



# Analytical Laboratory Report

Lab Sample ID: S62474.10

Sample Tag: Meth Blank

Collected Date/Time: 05/22/2024 00:01

Matrix: Methanol

COC Reference: 171234

### Sample Containers

#	Type	Preservative(s)	Refrigerated?	Arrival Temp. (C)	Thermometer #
1	40mL Glass	MeOH	Yes	6.0	IR

### Extraction / Prep.

Parameter	Result	Method	Run Date	Analyst	Flags
Sample wt. (g) / Methanol (ml)*	10/10	SW5035A	05/24/24 11:38	NDK	

### Organics

**Volatile Organics 5035, Method: SW5035A/8260C, Run Date: 05/25/24 18:38, Analyst: KAG**

Parameter	Result	RL	MDL	Units	Dilution	CAS#	Flags
Diethyl ether	Not detected	200		ug/kg	50	60-29-7	
Acetone	Not detected	1,000		ug/kg	50	67-64-1	
Methyl iodide	Not detected	100		ug/kg	50	74-88-4	
Carbon disulfide	Not detected	300		ug/kg	50	75-15-0	
tert-Methyl butyl ether (MTBE)	Not detected	200		ug/kg	50	1634-04-4	
Acrylonitrile	Not detected	100		ug/kg	50	107-13-1	
2-Butanone (MEK)	Not detected	750		ug/kg	50	78-93-3	
Dichlorodifluoromethane	Not detected	300		ug/kg	50	75-71-8	
Chloromethane	Not detected	300		ug/kg	50	74-87-3	
Vinyl chloride	Not detected	50		ug/kg	50	75-01-4	
Bromomethane	Not detected	200		ug/kg	50	74-83-9	
Chloroethane	Not detected	300		ug/kg	50	75-00-3	
Trichlorofluoromethane	Not detected	100		ug/kg	50	75-69-4	
1,1-Dichloroethene	Not detected	50		ug/kg	50	75-35-4	
Methylene chloride	Not detected	100		ug/kg	50	75-09-2	
trans-1,2-Dichloroethene	Not detected	50		ug/kg	50	156-60-5	
1,1-Dichloroethane	Not detected	50		ug/kg	50	75-34-3	
cis-1,2-Dichloroethene	Not detected	50		ug/kg	50	156-59-2	
Tetrahydrofuran*	Not detected	1,000		ug/kg	50	109-99-9	
Chloroform	Not detected	50		ug/kg	50	67-66-3	
Bromochloromethane	Not detected	100		ug/kg	50	74-97-5	
1,1,1-Trichloroethane	Not detected	50		ug/kg	50	71-55-6	
4-Methyl-2-pentanone (MIBK)	Not detected	3,000		ug/kg	50	108-10-1	
2-Hexanone	Not detected	3,000		ug/kg	50	591-78-6	
Carbon tetrachloride	Not detected	50		ug/kg	50	56-23-5	
Benzene	Not detected	50		ug/kg	50	71-43-2	
1,2-Dichloroethane	Not detected	50		ug/kg	50	107-06-2	
Trichloroethene	Not detected	50		ug/kg	50	79-01-6	
1,2-Dichloropropane	Not detected	50		ug/kg	50	78-87-5	
Bromodichloromethane	Not detected	100		ug/kg	50	75-27-4	
Dibromomethane	Not detected	300		ug/kg	50	74-95-3	
cis-1,3-Dichloropropene	Not detected	50		ug/kg	50	10061-01-5	
Toluene	Not detected	50		ug/kg	50	108-88-3	
trans-1,3-Dichloropropene	Not detected	50		ug/kg	50	10061-02-6	
1,1,2-Trichloroethane	Not detected	50		ug/kg	50	79-00-5	
Tetrachloroethene	Not detected	50		ug/kg	50	127-18-4	
trans-1,4-Dichloro-2-butene	Not detected	50		ug/kg	50	110-57-6	



# Analytical Laboratory Report

Lab Sample ID: S62474.10 (continued)

Sample Tag: Meth Blank

Volatile Organics 5035, Method: SW5035A/8260C, Run Date: 05/25/24 18:38, Analyst: KAG (continued)

Parameter	Result	RL	MDL	Units	Dilution	CAS#	Flags
Dibromochloromethane	Not detected	100		ug/kg	50	124-48-1	
1,2-Dibromoethane	Not detected	20		ug/kg	50	106-93-4	M
Chlorobenzene	Not detected	50		ug/kg	50	108-90-7	
1,1,1,2-Tetrachloroethane	Not detected	100		ug/kg	50	630-20-6	
Ethylbenzene	Not detected	50		ug/kg	50	100-41-4	
p,m-Xylene	Not detected	100		ug/kg	50		
o-Xylene	Not detected	50		ug/kg	50	95-47-6	
Styrene	Not detected	50		ug/kg	50	100-42-5	
Isopropylbenzene	Not detected	300		ug/kg	50	98-82-8	
Bromoform	Not detected	100		ug/kg	50	75-25-2	
1,1,2,2-Tetrachloroethane	Not detected	50		ug/kg	50	79-34-5	
1,2,3-Trichloropropane	Not detected	100		ug/kg	50	96-18-4	
n-Propylbenzene	Not detected	50		ug/kg	50	103-65-1	
Bromobenzene	Not detected	100		ug/kg	50	108-86-1	
1,3,5-Trimethylbenzene	Not detected	50		ug/kg	50	108-67-8	
tert-Butylbenzene	Not detected	50		ug/kg	50	98-06-6	
1,2,4-Trimethylbenzene	Not detected	50		ug/kg	50	95-63-6	
sec-Butylbenzene	Not detected	50		ug/kg	50	135-98-8	
p-Isopropyltoluene	Not detected	100		ug/kg	50	99-87-6	
1,3-Dichlorobenzene	Not detected	100		ug/kg	50	541-73-1	
1,4-Dichlorobenzene	Not detected	100		ug/kg	50	106-46-7	
1,2-Dichlorobenzene	Not detected	100		ug/kg	50	95-50-1	
1,2,3-Trimethylbenzene	Not detected	50		ug/kg	50	526-73-8	
n-Butylbenzene	Not detected	50		ug/kg	50	104-51-8	
Hexachloroethane	Not detected	300		ug/kg	50	67-72-1	
1,2-Dibromo-3-chloropropane	Not detected	300		ug/kg	50	96-12-8	
1,2,4-Trichlorobenzene	Not detected	330		ug/kg	50	120-82-1	
1,2,3-Trichlorobenzene	Not detected	330		ug/kg	50	87-61-6	
Naphthalene	Not detected	300		ug/kg	50	91-20-3	
2-Methylnaphthalene	Not detected	100		ug/kg	50	91-57-6	

M-Result reported to MDL not RDL



# Analytical Laboratory Report

Lab Sample ID: S62474.11

Sample Tag: SB-3-MW

Collected Date/Time: 05/23/2024 11:45

Matrix: Groundwater

COC Reference: 171234

Sample Containers

#	Type	Preservative(s)	Refrigerated?	Arrival Temp. (C)	Thermometer #
2	40mL Glass	HCL	Yes	6.0	IR
1	125mL Plastic	HNO3	Yes	6.0	IR
1	15mL Centrifuge Tube	None	Yes	6.0	IR
2	1L Amber	None	Yes	6.0	IR

Extraction / Prep.

Parameter	Result	Method	Run Date	Analyst	Flags
Initial wt. (g) / Final wt. (g) / Volume (ml)*	11.55/6.56/10	ASTMD7979-19M	05/24/24 11:00	SRP	
Mercury Digestion	Completed	E245.1	05/24/24 11:05	CTV	
pH check for VOCs*	<2	N/A	05/28/24 12:30	BDO	
Metal Digestion	Completed	SW3015A	05/31/24 11:50	CCM	
Extraction, PCB*	Completed	E608.3	05/30/24 10:00	JWR	
PNA Extraction	Completed	SW3510C	05/29/24 15:00	JWR	

Metals

Method: E200.8, Run Date: 05/31/24 14:14, Analyst: CCM

Parameter	Result	RL	MDL	Units	Dilution	CAS#	Flags
Arsenic	Not detected	0.002		mg/L	5	7440-38-2	
Barium	0.071	0.005		mg/L	5	7440-39-3	
Cadmium	Not detected	0.0005		mg/L	5	7440-43-9	
Chromium	Not detected	0.005		mg/L	5	7440-47-3	
Copper	0.006	0.005		mg/L	5	7440-50-8	
Lead	Not detected	0.003		mg/L	5	7439-92-1	
Selenium	Not detected	0.005		mg/L	5	7782-49-2	
Silver	Not detected	0.0005		mg/L	5	7440-22-4	
Zinc	0.012	0.005		mg/L	5	7440-66-6	

Method: E245.1, Run Date: 05/24/24 14:10, Analyst: CTV

Parameter	Result	RL	MDL	Units	Dilution	CAS#	Flags
Mercury	Not detected	0.0002		mg/L	1	7439-97-6	

Organics - PCBs/Pesticides

PCB, Method: E608.3, Run Date: 05/31/24 13:31, Analyst: JANB

Parameter	Result	RL	MDL	Units	Dilution	CAS#	Flags
PCB-1016	Not detected	0.1		ug/L	1	12674-11-2	
PCB-1221	Not detected	0.1		ug/L	1	11104-28-2	
PCB-1232	Not detected	0.1		ug/L	1	11141-16-5	
PCB-1242	Not detected	0.1		ug/L	1	53469-21-9	
PCB-1248	Not detected	0.1		ug/L	1	12672-29-6	
PCB-1254	Not detected	0.1		ug/L	1	11097-69-1	
PCB-1260	Not detected	0.1		ug/L	1	11096-82-5	
PCB, Total*	Not detected	0.1		ug/L	1	1336-36-3	





# Analytical Laboratory Report

Lab Sample ID: S62474.11 (continued)

Sample Tag: SB-3-MW

## Organics - Semi-Volatiles

Polynuclear Aromatic Hydrocarbon, Method: SW8270D, Run Date: 05/30/24 16:14, Analyst: PL

Parameter	Result	RL	MDL	Units	Dilution	CAS#	Flags
Acenaphthene	Not detected	5		ug/L	2	83-32-9	
Acenaphthylene	Not detected	5		ug/L	2	208-96-8	
Anthracene	Not detected	5		ug/L	2	120-12-7	
Benzo(a)anthracene	Not detected	1		ug/L	2	56-55-3	
Benzo(a)pyrene	Not detected	1		ug/L	2	50-32-8	
Benzo(b)fluoranthene	Not detected	1		ug/L	2	205-99-2	
Benzo(k)fluoranthene	Not detected	1		ug/L	2	207-08-9	
Benzo(ghi)perylene	Not detected	1		ug/L	2	191-24-2	
Chrysene	Not detected	1		ug/L	2	218-01-9	
Dibenzo(ah)anthracene	Not detected	2		ug/L	2	53-70-3	
Fluoranthene	Not detected	1		ug/L	2	206-44-0	
Fluorene	Not detected	5		ug/L	2	86-73-7	
Indeno(1,2,3-cd)pyrene	Not detected	2		ug/L	2	193-39-5	
Naphthalene	Not detected	5		ug/L	2	91-20-3	
Phenanthrene	Not detected	2		ug/L	2	85-01-8	
Pyrene	Not detected	5		ug/L	2	129-00-0	
2-Methylnaphthalene	Not detected	5		ug/L	2	91-57-6	
1-Methylnaphthalene	Not detected	5		ug/L	2	90-12-0	

## Organics

28 PFAs, Method: ASTM D7979-19M, Run Date: 05/24/24 17:55, Analyst: KCV

Parameter	Result	RL	MDL	Units	Dilution	CAS#	Flags
PFBA*	32	10		ng/L	2	375-22-4	
PFPeA*	4.3	4.0		ng/L	2	2706-90-3	
4:2 FTSA*	Not detected	2.0		ng/L	2	757124-72-4	
PFHxA*	5.5	2.0		ng/L	2	307-24-4	
PFBS*	2.5	2.0		ng/L	2	375-73-5	
PFHpA*	4.0	2.0		ng/L	2	375-85-9	
PFPeS*	Not detected	2.0		ng/L	2	2706-91-4	
6:2 FTSA*	Not detected	2.0		ng/L	2	27619-97-2	
PFOA*	91	2.0		ng/L	2	335-67-1	
PFHxS*	3.0	2.0		ng/L	2	355-46-4	
PFHxS-LN*	2.1	2.0		ng/L	2	355-46-4-LN	
PFHxS-BR*	Not detected	2.0		ng/L	2	355-46-4-BR	
PFNA*	Not detected	2.0		ng/L	2	375-95-1	
8:2 FTSA*	Not detected	2.0		ng/L	2	39108-34-4	
PFHpS*	Not detected	2.0		ng/L	2	375-92-8	
PFDA*	Not detected	2.0		ng/L	2	335-76-2	
N-MeFOSAA*	Not detected	2.0		ng/L	2	2355-31-9	
EtFOSAA*	Not detected	4.0		ng/L	2	2991-50-6	
PFOS*	11	2.0		ng/L	2	1763-23-1	
PFOS-LN*	4.8	2.0		ng/L	2	1763-23-1-LN	
PFOS-BR*	5.0	2.0		ng/L	2	1763-23-1-BR	
PFUnDA*	Not detected	2.0		ng/L	2	2058-94-8	
PFNS*	Not detected	2.0		ng/L	2	68259-12-1	
PFDODA*	Not detected	2.0		ng/L	2	307-55-1	
PFDS*	Not detected	2.0		ng/L	2	335-77-3	
PFTTrDA*	Not detected	2.0		ng/L	2	72629-94-8	
FOSA*	Not detected	2.0		ng/L	2	754-91-6	



# Analytical Laboratory Report

Lab Sample ID: S62474.11 (continued)

Sample Tag: SB-3-MW

## 28 PFAs, Method: ASTMD7979-19M, Run Date: 05/24/24 17:55, Analyst: KCV (continued)

Parameter	Result	RL	MDL	Units	Dilution	CAS#	Flags
PFTeDA*	Not detected	4.0		ng/L	2	376-06-7	
11Cl-PF3OUdS*	Not detected	2.0		ng/L	2	763051-92-9	
9Cl-PF3ONS*	Not detected	2.0		ng/L	2	756426-58-1	
ADONA*	Not detected	2.0		ng/L	2	919005-14-4	
HFPO-DA*	Not detected	10		ng/L	2	13252-13-6	

## Volatile Organics - DEQ List, Method: SW5030C/8260C, Run Date: 05/25/24 06:35, Analyst: NDK

Parameter	Result	RL	MDL	Units	Dilution	CAS#	Flags
Diethyl ether	Not detected	10		ug/L	1	60-29-7	
Acetone	Not detected	50		ug/L	1	67-64-1	
Methyl iodide	Not detected	1		ug/L	1	74-88-4	
Carbon disulfide	Not detected	5		ug/L	1	75-15-0	
tert-Methyl butyl ether (MTBE)	Not detected	5		ug/L	1	1634-04-4	
Acrylonitrile	Not detected	2		ug/L	1	107-13-1	
2-Butanone (MEK)	Not detected	25		ug/L	1	78-93-3	
Dichlorodifluoromethane	Not detected	5		ug/L	1	75-71-8	
Chloromethane	Not detected	5		ug/L	1	74-87-3	
Vinyl chloride	Not detected	1		ug/L	1	75-01-4	
Bromomethane	Not detected	5		ug/L	1	74-83-9	
Chloroethane	Not detected	5		ug/L	1	75-00-3	
Trichlorofluoromethane	Not detected	1		ug/L	1	75-69-4	
1,1-Dichloroethene	Not detected	1		ug/L	1	75-35-4	
Methylene chloride	Not detected	5		ug/L	1	75-09-2	
trans-1,2-Dichloroethene	Not detected	1		ug/L	1	156-60-5	
1,1-Dichloroethane	Not detected	1		ug/L	1	75-34-3	
cis-1,2-Dichloroethene	Not detected	1		ug/L	1	156-59-2	
Tetrahydrofuran*	Not detected	90		ug/L	1	109-99-9	
Chloroform	Not detected	1		ug/L	1	67-66-3	
Bromochloromethane	Not detected	1		ug/L	1	74-97-5	
1,1,1-Trichloroethane	Not detected	1		ug/L	1	71-55-6	
4-Methyl-2-pentanone (MIBK)	Not detected	50		ug/L	1	108-10-1	
2-Hexanone	Not detected	50		ug/L	1	591-78-6	
Carbon tetrachloride	Not detected	1		ug/L	1	56-23-5	
Benzene	Not detected	1		ug/L	1	71-43-2	
1,2-Dichloroethane	Not detected	1		ug/L	1	107-06-2	
Trichloroethene	Not detected	1		ug/L	1	79-01-6	
1,2-Dichloropropane	Not detected	1		ug/L	1	78-87-5	
Bromodichloromethane	Not detected	1		ug/L	1	75-27-4	
Dibromomethane	Not detected	5		ug/L	1	74-95-3	
cis-1,3-Dichloropropene	Not detected	1		ug/L	1	10061-01-5	
Toluene	Not detected	1		ug/L	1	108-88-3	
trans-1,3-Dichloropropene	Not detected	1		ug/L	1	10061-02-6	
1,1,2-Trichloroethane	Not detected	1		ug/L	1	79-00-5	
Tetrachloroethene	Not detected	1		ug/L	1	127-18-4	
trans-1,4-Dichloro-2-butene	Not detected	1		ug/L	1	110-57-6	
Dibromochloromethane	Not detected	5		ug/L	1	124-48-1	
1,2-Dibromoethane	Not detected	1		ug/L	1	106-93-4	
Chlorobenzene	Not detected	1		ug/L	1	108-90-7	
1,1,1,2-Tetrachloroethane	Not detected	1		ug/L	1	630-20-6	
Ethylbenzene	Not detected	1		ug/L	1	100-41-4	



# Analytical Laboratory Report

Lab Sample ID: S62474.11 (continued)

Sample Tag: SB-3-MW

**Volatile Organics - DEQ List, Method: SW5030C/8260C, Run Date: 05/25/24 06:35, Analyst: NDK (continued)**

Parameter	Result	RL	MDL	Units	Dilution	CAS#	Flags
p,m-Xylene*	Not detected	2		ug/L	1		
o-Xylene	Not detected	1		ug/L	1	95-47-6	
Styrene	Not detected	1		ug/L	1	100-42-5	
Isopropylbenzene	Not detected	5		ug/L	1	98-82-8	
Bromoform	Not detected	1		ug/L	1	75-25-2	
1,1,2,2-Tetrachloroethane	Not detected	1		ug/L	1	79-34-5	
1,2,3-Trichloropropane	Not detected	1		ug/L	1	96-18-4	
n-Propylbenzene	Not detected	1		ug/L	1	103-65-1	
Bromobenzene	Not detected	1		ug/L	1	108-86-1	
1,3,5-Trimethylbenzene	Not detected	1		ug/L	1	108-67-8	
tert-Butylbenzene	Not detected	1		ug/L	1	98-06-6	
1,2,4-Trimethylbenzene	Not detected	1		ug/L	1	95-63-6	
sec-Butylbenzene	Not detected	1		ug/L	1	135-98-8	
p-Isopropyltoluene	Not detected	5		ug/L	1	99-87-6	
1,3-Dichlorobenzene	Not detected	1		ug/L	1	541-73-1	
1,4-Dichlorobenzene	Not detected	1		ug/L	1	106-46-7	
1,2-Dichlorobenzene	Not detected	1		ug/L	1	95-50-1	
1,2,3-Trimethylbenzene	Not detected	1		ug/L	1	526-73-8	
n-Butylbenzene	Not detected	1		ug/L	1	104-51-8	
Hexachloroethane	Not detected	5		ug/L	1	67-72-1	
1,2-Dibromo-3-chloropropane	Not detected	5		ug/L	1	96-12-8	
1,2,4-Trichlorobenzene	Not detected	5		ug/L	1	120-82-1	
1,2,3-Trichlorobenzene	Not detected	5		ug/L	1	87-61-6	
Naphthalene	Not detected	5		ug/L	1	91-20-3	
2-Methylnaphthalene	Not detected	5		ug/L	1	91-57-6	

**Method: RSK-175, Run Date: 05/28/24 00:08, Analyst: EF**

Parameter	Result	RL	MDL	Units	Dilution	CAS#	Flags
Dissolved Gases*	Completed				1		O

O-Analysis performed by outside laboratory. See attached report.



# Analytical Laboratory Report

Lab Sample ID: S62474.12

Sample Tag: SB-4-MW

Collected Date/Time: 05/23/2024 13:38

Matrix: Groundwater

COC Reference: 171234

Sample Containers

#	Type	Preservative(s)	Refrigerated?	Arrival Temp. (C)	Thermometer #
2	40mL Glass	HCL	Yes	6.0	IR
1	125mL Plastic	HNO3	Yes	6.0	IR
1	15mL Centrifuge Tube	None	Yes	6.0	IR
2	1L Amber	None	Yes	6.0	IR

Extraction / Prep.

Parameter	Result	Method	Run Date	Analyst	Flags
Initial wt. (g) / Final wt. (g) / Volume (ml)*	11.27/6.52/10	ASTMD7979-19M	05/24/24 11:00	SRP	
Mercury Digestion	Completed	E245.1	05/24/24 11:05	CTV	
pH check for VOCs*	<2	N/A	05/28/24 12:30	BDO	
Metal Digestion	Completed	SW3015A	05/31/24 11:50	CCM	
Extraction, PCB*	Completed	E608.3	05/30/24 10:00	JWR	
PNA Extraction	Completed	SW3510C	05/29/24 15:00	JWR	

Metals

Method: E200.8, Run Date: 05/31/24 14:18, Analyst: CCM

Parameter	Result	RL	MDL	Units	Dilution	CAS#	Flags
Arsenic	Not detected	0.002		mg/L	5	7440-38-2	
Barium	0.094	0.005		mg/L	5	7440-39-3	
Cadmium	Not detected	0.0005		mg/L	5	7440-43-9	
Chromium	Not detected	0.005		mg/L	5	7440-47-3	
Copper	Not detected	0.005		mg/L	5	7440-50-8	
Lead	Not detected	0.003		mg/L	5	7439-92-1	
Selenium	Not detected	0.005		mg/L	5	7782-49-2	
Silver	Not detected	0.0005		mg/L	5	7440-22-4	
Zinc	0.026	0.005		mg/L	5	7440-66-6	

Method: E245.1, Run Date: 05/24/24 14:13, Analyst: CTV

Parameter	Result	RL	MDL	Units	Dilution	CAS#	Flags
Mercury	Not detected	0.0002		mg/L	1	7439-97-6	

Organics - PCBs/Pesticides

PCB, Method: E608.3, Run Date: 05/31/24 13:50, Analyst: JANB

Parameter	Result	RL	MDL	Units	Dilution	CAS#	Flags
PCB-1016	Not detected	0.1		ug/L	1	12674-11-2	
PCB-1221	Not detected	0.1		ug/L	1	11104-28-2	
PCB-1232	Not detected	0.1		ug/L	1	11141-16-5	
PCB-1242	Not detected	0.1		ug/L	1	53469-21-9	
PCB-1248	Not detected	0.1		ug/L	1	12672-29-6	
PCB-1254	Not detected	0.1		ug/L	1	11097-69-1	
PCB-1260	Not detected	0.1		ug/L	1	11096-82-5	
PCB, Total*	Not detected	0.1		ug/L	1	1336-36-3	



# Analytical Laboratory Report

Lab Sample ID: S62474.12 (continued)

Sample Tag: SB-4-MW

## Organics - Semi-Volatiles

**Polynuclear Aromatic Hydrocarbon, Method: SW8270D, Run Date: 05/30/24 16:37, Analyst: PL**

Parameter	Result	RL	MDL	Units	Dilution	CAS#	Flags
Acenaphthene	Not detected	5		ug/L	2	83-32-9	
Acenaphthylene	Not detected	5		ug/L	2	208-96-8	
Anthracene	Not detected	5		ug/L	2	120-12-7	
Benzo(a)anthracene	Not detected	1		ug/L	2	56-55-3	
Benzo(a)pyrene	Not detected	1		ug/L	2	50-32-8	
Benzo(b)fluoranthene	Not detected	1		ug/L	2	205-99-2	
Benzo(k)fluoranthene	Not detected	1		ug/L	2	207-08-9	
Benzo(ghi)perylene	Not detected	1		ug/L	2	191-24-2	
Chrysene	Not detected	1		ug/L	2	218-01-9	
Dibenzo(ah)anthracene	Not detected	2		ug/L	2	53-70-3	
Fluoranthene	Not detected	1		ug/L	2	206-44-0	
Fluorene	Not detected	5		ug/L	2	86-73-7	
Indeno(1,2,3-cd)pyrene	Not detected	2		ug/L	2	193-39-5	
Naphthalene	Not detected	5		ug/L	2	91-20-3	
Phenanthrene	Not detected	2		ug/L	2	85-01-8	
Pyrene	Not detected	5		ug/L	2	129-00-0	
2-Methylnaphthalene	Not detected	5		ug/L	2	91-57-6	
1-Methylnaphthalene	Not detected	5		ug/L	2	90-12-0	

## Organics

**28 PFAs, Method: ASTM D7979-19M, Run Date: 05/24/24 18:15, Analyst: KCV**

Parameter	Result	RL	MDL	Units	Dilution	CAS#	Flags
PFBA*	30	11		ng/L	2.11	375-22-4	
PFPeA*	Not detected	4.2		ng/L	2.11	2706-90-3	
4:2 FTSA*	Not detected	2.1		ng/L	2.11	757124-72-4	
PFHxA*	4.9	2.1		ng/L	2.11	307-24-4	
PFBS*	4.1	2.1		ng/L	2.11	375-73-5	
PFHpA*	Not detected	2.1		ng/L	2.11	375-85-9	
PFPeS*	Not detected	2.1		ng/L	2.11	2706-91-4	
6:2 FTSA*	Not detected	2.1		ng/L	2.11	27619-97-2	
PFOA*	3.5	2.1		ng/L	2.11	335-67-1	
PFHxS*	2.2	2.1		ng/L	2.11	355-46-4	
PFHxS-LN*	Not detected	2.1		ng/L	2.11	355-46-4-LN	
PFHxS-BR*	Not detected	2.1		ng/L	2.11	355-46-4-BR	
PFNA*	Not detected	2.1		ng/L	2.11	375-95-1	
8:2 FTSA*	Not detected	2.1		ng/L	2.11	39108-34-4	
PFHpS*	Not detected	2.1		ng/L	2.11	375-92-8	
PFDA*	Not detected	2.1		ng/L	2.11	335-76-2	
N-MeFOSAA*	Not detected	2.1		ng/L	2.11	2355-31-9	
EtFOSAA*	Not detected	4.2		ng/L	2.11	2991-50-6	
PFOS*	Not detected	2.1		ng/L	2.11	1763-23-1	
PFOS-LN*	Not detected	2.1		ng/L	2.11	1763-23-1-LN	
PFOS-BR*	Not detected	2.1		ng/L	2.11	1763-23-1-BR	
PFUnDA*	Not detected	2.1		ng/L	2.11	2058-94-8	
PFNS*	Not detected	2.1		ng/L	2.11	68259-12-1	
PFDODA*	Not detected	2.1		ng/L	2.11	307-55-1	
PFDS*	Not detected	2.1		ng/L	2.11	335-77-3	
PFTTrDA*	Not detected	2.1		ng/L	2.11	72629-94-8	
FOSA*	Not detected	2.1		ng/L	2.11	754-91-6	



# Analytical Laboratory Report

Lab Sample ID: S62474.12 (continued)

Sample Tag: SB-4-MW

**28 PFAs, Method: ASTMD7979-19M, Run Date: 05/24/24 18:15, Analyst: KCV (continued)**

Parameter	Result	RL	MDL	Units	Dilution	CAS#	Flags
PFTeDA*	Not detected	4.2		ng/L	2.11	376-06-7	
11Cl-PF3OUdS*	Not detected	2.1		ng/L	2.11	763051-92-9	
9Cl-PF3ONS*	Not detected	2.1		ng/L	2.11	756426-58-1	
ADONA*	Not detected	2.1		ng/L	2.11	919005-14-4	
HFPO-DA*	Not detected	11		ng/L	2.11	13252-13-6	

**Volatile Organics - DEQ List, Method: SW5030C/8260C, Run Date: 05/25/24 06:59, Analyst: NDK**

Parameter	Result	RL	MDL	Units	Dilution	CAS#	Flags
Diethyl ether	Not detected	10		ug/L	1	60-29-7	
Acetone	Not detected	50		ug/L	1	67-64-1	
Methyl iodide	Not detected	1		ug/L	1	74-88-4	
Carbon disulfide	Not detected	5		ug/L	1	75-15-0	
tert-Methyl butyl ether (MTBE)	Not detected	5		ug/L	1	1634-04-4	
Acrylonitrile	Not detected	2		ug/L	1	107-13-1	
2-Butanone (MEK)	Not detected	25		ug/L	1	78-93-3	
Dichlorodifluoromethane	Not detected	5		ug/L	1	75-71-8	
Chloromethane	Not detected	5		ug/L	1	74-87-3	
Vinyl chloride	Not detected	1		ug/L	1	75-01-4	
Bromomethane	Not detected	5		ug/L	1	74-83-9	
Chloroethane	Not detected	5		ug/L	1	75-00-3	
Trichlorofluoromethane	Not detected	1		ug/L	1	75-69-4	
1,1-Dichloroethene	Not detected	1		ug/L	1	75-35-4	
Methylene chloride	Not detected	5		ug/L	1	75-09-2	
trans-1,2-Dichloroethene	Not detected	1		ug/L	1	156-60-5	
1,1-Dichloroethane	Not detected	1		ug/L	1	75-34-3	
cis-1,2-Dichloroethene	Not detected	1		ug/L	1	156-59-2	
Tetrahydrofuran*	Not detected	90		ug/L	1	109-99-9	
Chloroform	Not detected	1		ug/L	1	67-66-3	
Bromochloromethane	Not detected	1		ug/L	1	74-97-5	
1,1,1-Trichloroethane	Not detected	1		ug/L	1	71-55-6	
4-Methyl-2-pentanone (MIBK)	Not detected	50		ug/L	1	108-10-1	
2-Hexanone	Not detected	50		ug/L	1	591-78-6	
Carbon tetrachloride	Not detected	1		ug/L	1	56-23-5	
Benzene	Not detected	1		ug/L	1	71-43-2	
1,2-Dichloroethane	Not detected	1		ug/L	1	107-06-2	
Trichloroethene	Not detected	1		ug/L	1	79-01-6	
1,2-Dichloropropane	Not detected	1		ug/L	1	78-87-5	
Bromodichloromethane	Not detected	1		ug/L	1	75-27-4	
Dibromomethane	Not detected	5		ug/L	1	74-95-3	
cis-1,3-Dichloropropene	Not detected	1		ug/L	1	10061-01-5	
Toluene	Not detected	1		ug/L	1	108-88-3	
trans-1,3-Dichloropropene	Not detected	1		ug/L	1	10061-02-6	
1,1,2-Trichloroethane	Not detected	1		ug/L	1	79-00-5	
Tetrachloroethene	Not detected	1		ug/L	1	127-18-4	
trans-1,4-Dichloro-2-butene	Not detected	1		ug/L	1	110-57-6	
Dibromochloromethane	Not detected	5		ug/L	1	124-48-1	
1,2-Dibromoethane	Not detected	1		ug/L	1	106-93-4	
Chlorobenzene	Not detected	1		ug/L	1	108-90-7	
1,1,1,2-Tetrachloroethane	Not detected	1		ug/L	1	630-20-6	
Ethylbenzene	Not detected	1		ug/L	1	100-41-4	



# Analytical Laboratory Report

Lab Sample ID: S62474.12 (continued)

Sample Tag: SB-4-MW

**Volatile Organics - DEQ List, Method: SW5030C/8260C, Run Date: 05/25/24 06:59, Analyst: NDK (continued)**

Parameter	Result	RL	MDL	Units	Dilution	CAS#	Flags
p,m-Xylene*	Not detected	2		ug/L	1		
o-Xylene	Not detected	1		ug/L	1	95-47-6	
Styrene	Not detected	1		ug/L	1	100-42-5	
Isopropylbenzene	Not detected	5		ug/L	1	98-82-8	
Bromoform	Not detected	1		ug/L	1	75-25-2	
1,1,2,2-Tetrachloroethane	Not detected	1		ug/L	1	79-34-5	
1,2,3-Trichloropropane	Not detected	1		ug/L	1	96-18-4	
n-Propylbenzene	Not detected	1		ug/L	1	103-65-1	
Bromobenzene	Not detected	1		ug/L	1	108-86-1	
1,3,5-Trimethylbenzene	Not detected	1		ug/L	1	108-67-8	
tert-Butylbenzene	Not detected	1		ug/L	1	98-06-6	
1,2,4-Trimethylbenzene	Not detected	1		ug/L	1	95-63-6	
sec-Butylbenzene	Not detected	1		ug/L	1	135-98-8	
p-Isopropyltoluene	Not detected	5		ug/L	1	99-87-6	
1,3-Dichlorobenzene	Not detected	1		ug/L	1	541-73-1	
1,4-Dichlorobenzene	Not detected	1		ug/L	1	106-46-7	
1,2-Dichlorobenzene	Not detected	1		ug/L	1	95-50-1	
1,2,3-Trimethylbenzene	Not detected	1		ug/L	1	526-73-8	
n-Butylbenzene	Not detected	1		ug/L	1	104-51-8	
Hexachloroethane	Not detected	5		ug/L	1	67-72-1	
1,2-Dibromo-3-chloropropane	Not detected	5		ug/L	1	96-12-8	
1,2,4-Trichlorobenzene	Not detected	5		ug/L	1	120-82-1	
1,2,3-Trichlorobenzene	Not detected	5		ug/L	1	87-61-6	
Naphthalene	Not detected	5		ug/L	1	91-20-3	
2-Methylnaphthalene	Not detected	5		ug/L	1	91-57-6	

**Method: RSK-175, Run Date: 05/28/24 00:25, Analyst: EF**

Parameter	Result	RL	MDL	Units	Dilution	CAS#	Flags
Dissolved Gases*	Completed				1		O

O-Analysis performed by outside laboratory. See attached report.



# Analytical Laboratory Report

Lab Sample ID: S62474.13

Sample Tag: DUP-1GW

Collected Date/Time: 05/23/2024 00:01

Matrix: Groundwater

COC Reference: 171235

Sample Containers

#	Type	Preservative(s)	Refrigerated?	Arrival Temp. (C)	Thermometer #
2	40mL Glass	HCL	Yes	6.0	IR
1	125mL Plastic	HNO3	Yes	6.0	IR
1	15mL Centrifuge Tube	None	Yes	6.0	IR
2	1L Amber	None	Yes	6.0	IR

Extraction / Prep.

Parameter	Result	Method	Run Date	Analyst	Flags
Initial wt. (g) / Final wt. (g) / Volume (ml)*	11.38/6.53/10	ASTMD7979-19M	05/24/24 11:00	SRP	
Mercury Digestion	Completed	E245.1	05/24/24 11:05	CTV	
pH check for VOCs*	<2	N/A	05/28/24 12:30	BDO	
Metal Digestion	Completed	SW3015A	05/31/24 11:50	CCM	
Extraction, PCB*	Completed	E608.3	05/30/24 10:00	JWR	
PNA Extraction	Completed	SW3510C	05/29/24 15:00	JWR	

Metals

Method: E200.8, Run Date: 05/31/24 14:24, Analyst: CCM

Parameter	Result	RL	MDL	Units	Dilution	CAS#	Flags
Arsenic	Not detected	0.002		mg/L	5	7440-38-2	
Barium	0.069	0.005		mg/L	5	7440-39-3	
Cadmium	Not detected	0.0005		mg/L	5	7440-43-9	
Chromium	Not detected	0.005		mg/L	5	7440-47-3	
Copper	0.005	0.005		mg/L	5	7440-50-8	
Lead	Not detected	0.003		mg/L	5	7439-92-1	
Selenium	Not detected	0.005		mg/L	5	7782-49-2	
Silver	Not detected	0.0005		mg/L	5	7440-22-4	
Zinc	0.012	0.005		mg/L	5	7440-66-6	

Method: E245.1, Run Date: 05/24/24 14:16, Analyst: CTV

Parameter	Result	RL	MDL	Units	Dilution	CAS#	Flags
Mercury	Not detected	0.0002		mg/L	1	7439-97-6	

Organics - PCBs/Pesticides

PCB, Method: E608.3, Run Date: 05/31/24 14:10, Analyst: JANB

Parameter	Result	RL	MDL	Units	Dilution	CAS#	Flags
PCB-1016	Not detected	0.1		ug/L	1	12674-11-2	
PCB-1221	Not detected	0.1		ug/L	1	11104-28-2	
PCB-1232	Not detected	0.1		ug/L	1	11141-16-5	
PCB-1242	Not detected	0.1		ug/L	1	53469-21-9	
PCB-1248	Not detected	0.1		ug/L	1	12672-29-6	
PCB-1254	Not detected	0.1		ug/L	1	11097-69-1	
PCB-1260	Not detected	0.1		ug/L	1	11096-82-5	
PCB, Total*	Not detected	0.1		ug/L	1	1336-36-3	





# Analytical Laboratory Report

Lab Sample ID: S62474.13 (continued)

Sample Tag: DUP-1GW

## Organics - Semi-Volatiles

Polynuclear Aromatic Hydrocarbon, Method: SW8270D, Run Date: 05/30/24 17:00, Analyst: PL

Parameter	Result	RL	MDL	Units	Dilution	CAS#	Flags
Acenaphthene	Not detected	5		ug/L	2	83-32-9	
Acenaphthylene	Not detected	5		ug/L	2	208-96-8	
Anthracene	Not detected	5		ug/L	2	120-12-7	
Benzo(a)anthracene	Not detected	1		ug/L	2	56-55-3	
Benzo(a)pyrene	Not detected	1		ug/L	2	50-32-8	
Benzo(b)fluoranthene	Not detected	1		ug/L	2	205-99-2	
Benzo(k)fluoranthene	Not detected	1		ug/L	2	207-08-9	
Benzo(ghi)perylene	Not detected	1		ug/L	2	191-24-2	
Chrysene	Not detected	1		ug/L	2	218-01-9	
Dibenzo(ah)anthracene	Not detected	2		ug/L	2	53-70-3	
Fluoranthene	Not detected	1		ug/L	2	206-44-0	
Fluorene	Not detected	5		ug/L	2	86-73-7	
Indeno(1,2,3-cd)pyrene	Not detected	2		ug/L	2	193-39-5	
Naphthalene	Not detected	5		ug/L	2	91-20-3	
Phenanthrene	Not detected	2		ug/L	2	85-01-8	
Pyrene	Not detected	5		ug/L	2	129-00-0	
2-Methylnaphthalene	Not detected	5		ug/L	2	91-57-6	
1-Methylnaphthalene	Not detected	5		ug/L	2	90-12-0	

## Organics

28 PFAs, Method: ASTM D7979-19M, Run Date: 05/24/24 18:35, Analyst: KCV

Parameter	Result	RL	MDL	Units	Dilution	CAS#	Flags
PFBA*	30	10		ng/L	2.06	375-22-4	
PFPeA*	Not detected	4.1		ng/L	2.06	2706-90-3	
4:2 FTSA*	Not detected	2.1		ng/L	2.06	757124-72-4	
PFHxA*	6.0	2.1		ng/L	2.06	307-24-4	
PFBS*	3.1	2.1		ng/L	2.06	375-73-5	
PFHpA*	3.9	2.1		ng/L	2.06	375-85-9	
PFPeS*	Not detected	2.1		ng/L	2.06	2706-91-4	
6:2 FTSA*	Not detected	2.1		ng/L	2.06	27619-97-2	
PFOA*	86	2.1		ng/L	2.06	335-67-1	
PFHxS*	3.5	2.1		ng/L	2.06	355-46-4	
PFHxS-LN*	2.6	2.1		ng/L	2.06	355-46-4-LN	
PFHxS-BR*	Not detected	2.1		ng/L	2.06	355-46-4-BR	
PFNA*	Not detected	2.1		ng/L	2.06	375-95-1	
8:2 FTSA*	Not detected	2.1		ng/L	2.06	39108-34-4	
PFHpS*	Not detected	2.1		ng/L	2.06	375-92-8	
PFDA*	Not detected	2.1		ng/L	2.06	335-76-2	
N-MeFOSAA*	Not detected	2.1		ng/L	2.06	2355-31-9	
EtFOSAA*	Not detected	4.1		ng/L	2.06	2991-50-6	
PFOS*	12	2.1		ng/L	2.06	1763-23-1	
PFOS-LN*	4.6	2.1		ng/L	2.06	1763-23-1-LN	
PFOS-BR*	6.3	2.1		ng/L	2.06	1763-23-1-BR	
PFUnDA*	Not detected	2.1		ng/L	2.06	2058-94-8	
PFNS*	Not detected	2.1		ng/L	2.06	68259-12-1	
PFDODA*	Not detected	2.1		ng/L	2.06	307-55-1	
PFDS*	Not detected	2.1		ng/L	2.06	335-77-3	
PFTTrDA*	Not detected	2.1		ng/L	2.06	72629-94-8	
FOSA*	Not detected	2.1		ng/L	2.06	754-91-6	



# Analytical Laboratory Report

Lab Sample ID: S62474.13 (continued)

Sample Tag: DUP-1GW

**28 PFAs, Method: ASTMD7979-19M, Run Date: 05/24/24 18:35, Analyst: KCV (continued)**

Parameter	Result	RL	MDL	Units	Dilution	CAS#	Flags
PFTeDA*	Not detected	4.1		ng/L	2.06	376-06-7	
11Cl-PF3OUdS*	Not detected	2.1		ng/L	2.06	763051-92-9	
9Cl-PF3ONS*	Not detected	2.1		ng/L	2.06	756426-58-1	
ADONA*	Not detected	2.1		ng/L	2.06	919005-14-4	
HFPO-DA*	Not detected	10		ng/L	2.06	13252-13-6	

**Volatile Organics - DEQ List, Method: SW5030C/8260C, Run Date: 05/25/24 07:22, Analyst: NDK**

Parameter	Result	RL	MDL	Units	Dilution	CAS#	Flags
Diethyl ether	Not detected	10		ug/L	1	60-29-7	
Acetone	Not detected	50		ug/L	1	67-64-1	
Methyl iodide	Not detected	1		ug/L	1	74-88-4	
Carbon disulfide	Not detected	5		ug/L	1	75-15-0	
tert-Methyl butyl ether (MTBE)	Not detected	5		ug/L	1	1634-04-4	
Acrylonitrile	Not detected	2		ug/L	1	107-13-1	
2-Butanone (MEK)	Not detected	25		ug/L	1	78-93-3	
Dichlorodifluoromethane	Not detected	5		ug/L	1	75-71-8	
Chloromethane	Not detected	5		ug/L	1	74-87-3	
Vinyl chloride	Not detected	1		ug/L	1	75-01-4	
Bromomethane	Not detected	5		ug/L	1	74-83-9	
Chloroethane	Not detected	5		ug/L	1	75-00-3	
Trichlorofluoromethane	Not detected	1		ug/L	1	75-69-4	
1,1-Dichloroethene	Not detected	1		ug/L	1	75-35-4	
Methylene chloride	Not detected	5		ug/L	1	75-09-2	
trans-1,2-Dichloroethene	Not detected	1		ug/L	1	156-60-5	
1,1-Dichloroethane	Not detected	1		ug/L	1	75-34-3	
cis-1,2-Dichloroethene	Not detected	1		ug/L	1	156-59-2	
Tetrahydrofuran*	Not detected	90		ug/L	1	109-99-9	
Chloroform	Not detected	1		ug/L	1	67-66-3	
Bromochloromethane	Not detected	1		ug/L	1	74-97-5	
1,1,1-Trichloroethane	Not detected	1		ug/L	1	71-55-6	
4-Methyl-2-pentanone (MIBK)	Not detected	50		ug/L	1	108-10-1	
2-Hexanone	Not detected	50		ug/L	1	591-78-6	
Carbon tetrachloride	Not detected	1		ug/L	1	56-23-5	
Benzene	Not detected	1		ug/L	1	71-43-2	
1,2-Dichloroethane	Not detected	1		ug/L	1	107-06-2	
Trichloroethene	Not detected	1		ug/L	1	79-01-6	
1,2-Dichloropropane	Not detected	1		ug/L	1	78-87-5	
Bromodichloromethane	Not detected	1		ug/L	1	75-27-4	
Dibromomethane	Not detected	5		ug/L	1	74-95-3	
cis-1,3-Dichloropropene	Not detected	1		ug/L	1	10061-01-5	
Toluene	Not detected	1		ug/L	1	108-88-3	
trans-1,3-Dichloropropene	Not detected	1		ug/L	1	10061-02-6	
1,1,2-Trichloroethane	Not detected	1		ug/L	1	79-00-5	
Tetrachloroethene	Not detected	1		ug/L	1	127-18-4	
trans-1,4-Dichloro-2-butene	Not detected	1		ug/L	1	110-57-6	
Dibromochloromethane	Not detected	5		ug/L	1	124-48-1	
1,2-Dibromoethane	Not detected	1		ug/L	1	106-93-4	
Chlorobenzene	Not detected	1		ug/L	1	108-90-7	
1,1,1,2-Tetrachloroethane	Not detected	1		ug/L	1	630-20-6	
Ethylbenzene	Not detected	1		ug/L	1	100-41-4	



# Analytical Laboratory Report

Lab Sample ID: S62474.13 (continued)

Sample Tag: DUP-1GW

**Volatile Organics - DEQ List, Method: SW5030C/8260C, Run Date: 05/25/24 07:22, Analyst: NDK (continued)**

Parameter	Result	RL	MDL	Units	Dilution	CAS#	Flags
p,m-Xylene*	Not detected	2		ug/L	1		
o-Xylene	Not detected	1		ug/L	1	95-47-6	
Styrene	Not detected	1		ug/L	1	100-42-5	
Isopropylbenzene	Not detected	5		ug/L	1	98-82-8	
Bromoform	Not detected	1		ug/L	1	75-25-2	
1,1,2,2-Tetrachloroethane	Not detected	1		ug/L	1	79-34-5	
1,2,3-Trichloropropane	Not detected	1		ug/L	1	96-18-4	
n-Propylbenzene	Not detected	1		ug/L	1	103-65-1	
Bromobenzene	Not detected	1		ug/L	1	108-86-1	
1,3,5-Trimethylbenzene	Not detected	1		ug/L	1	108-67-8	
tert-Butylbenzene	Not detected	1		ug/L	1	98-06-6	
1,2,4-Trimethylbenzene	Not detected	1		ug/L	1	95-63-6	
sec-Butylbenzene	Not detected	1		ug/L	1	135-98-8	
p-Isopropyltoluene	Not detected	5		ug/L	1	99-87-6	
1,3-Dichlorobenzene	Not detected	1		ug/L	1	541-73-1	
1,4-Dichlorobenzene	Not detected	1		ug/L	1	106-46-7	
1,2-Dichlorobenzene	Not detected	1		ug/L	1	95-50-1	
1,2,3-Trimethylbenzene	Not detected	1		ug/L	1	526-73-8	
n-Butylbenzene	Not detected	1		ug/L	1	104-51-8	
Hexachloroethane	Not detected	5		ug/L	1	67-72-1	
1,2-Dibromo-3-chloropropane	Not detected	5		ug/L	1	96-12-8	
1,2,4-Trichlorobenzene	Not detected	5		ug/L	1	120-82-1	
1,2,3-Trichlorobenzene	Not detected	5		ug/L	1	87-61-6	
Naphthalene	Not detected	5		ug/L	1	91-20-3	
2-Methylnaphthalene	Not detected	5		ug/L	1	91-57-6	

**Method: RSK-175, Run Date: 05/28/24 00:43, Analyst: EF**

Parameter	Result	RL	MDL	Units	Dilution	CAS#	Flags
Dissolved Gases*	Completed				1		O

O-Analysis performed by outside laboratory. See attached report.

# Merit Laboratories Login Checklist

Lab Set ID:S62474

Client:ASTI (ASTI Environmental)

Project: Hamlin & Adams / 13059-1

Submitted:05/24/2024 09:00 Login User: MMC

Attention: Tom Wackerman

Address: ASTI Environmental  
10448 Citation Drive  
Suite 100  
Brighton, MI 48116

Phone: 810-599-5463 FAX:

Email: twacker@asti-env.com

Selection	Description	Note
-----------	-------------	------

## Sample Receiving

- |     |  |  |
|-----|--|--|
| 01. | <input checked="" type="checkbox"/> Yes <input type="checkbox"/> No <input type="checkbox"/> N/A | Samples are received at 4C +/- 2C Thermometer # IR 6.0 |
| 02. | <input checked="" type="checkbox"/> Yes <input type="checkbox"/> No <input type="checkbox"/> N/A | Received on ice/ cooling process begun                 |
| 03. | <input type="checkbox"/> Yes <input checked="" type="checkbox"/> No <input type="checkbox"/> N/A | Samples shipped  |
| 04. | <input type="checkbox"/> Yes <input checked="" type="checkbox"/> No <input type="checkbox"/> N/A | Samples left in 24 hr. drop box                        |
| 05. | <input type="checkbox"/> Yes <input type="checkbox"/> No <input checked="" type="checkbox"/> N/A | Are there custody seals/tape or is the drop box locked |

## Chain of Custody

- |     |  |   |
|-----|--|---|
| 06. | <input checked="" type="checkbox"/> Yes <input type="checkbox"/> No <input type="checkbox"/> N/A | COC adequately filled out                         |
| 07. | <input checked="" type="checkbox"/> Yes <input type="checkbox"/> No <input type="checkbox"/> N/A | COC signed and relinquished to the lab            |
| 08. | <input checked="" type="checkbox"/> Yes <input type="checkbox"/> No <input type="checkbox"/> N/A | Sample tag on bottles match COC                   |
| 09. | <input checked="" type="checkbox"/> Yes <input type="checkbox"/> No <input type="checkbox"/> N/A | Subcontracting needed? Subcontracted to: Eurofins |

## Preservation

- |     |  |   |
|-----|--|---|
| 10. | <input checked="" type="checkbox"/> Yes <input type="checkbox"/> No <input type="checkbox"/> N/A | Do sample have correct chemical preservation        |
| 11. | <input type="checkbox"/> Yes <input type="checkbox"/> No <input checked="" type="checkbox"/> N/A | Completed pH checks on preserved samples? (no VOAs) |
| 12. | <input type="checkbox"/> Yes <input checked="" type="checkbox"/> No <input type="checkbox"/> N/A | Did any samples need to be preserved in the lab?    |

## Bottle Conditions

- |     |  |   |
|-----|--|---|
| 13. | <input checked="" type="checkbox"/> Yes <input type="checkbox"/> No <input type="checkbox"/> N/A | All bottles intact                            |
| 14. | <input checked="" type="checkbox"/> Yes <input type="checkbox"/> No <input type="checkbox"/> N/A | Appropriate analytical bottles are used       |
| 15. | <input checked="" type="checkbox"/> Yes <input type="checkbox"/> No <input type="checkbox"/> N/A | Merit bottles used                            |
| 16. | <input checked="" type="checkbox"/> Yes <input type="checkbox"/> No <input type="checkbox"/> N/A | Sufficient sample volume received             |
| 17. | <input type="checkbox"/> Yes <input checked="" type="checkbox"/> No <input type="checkbox"/> N/A | Samples require laboratory filtration         |
| 18. | <input checked="" type="checkbox"/> Yes <input type="checkbox"/> No <input type="checkbox"/> N/A | Samples submitted within holding time         |
| 19. | <input type="checkbox"/> Yes <input checked="" type="checkbox"/> No <input type="checkbox"/> N/A | Do water VOC or TOX bottles contain headspace |

Corrective action for all exceptions is to call the client and to notify the project manager.

Client Review By: \_\_\_\_\_ Date: \_\_\_\_\_

# Merit Laboratories Bottle Preservation Check

Lab Set ID: S62474      Submitted: 05/24/2024 09:00

Client: ASTI (ASTI Environmental)

Project: Hamlin & Adams / 13059-1

Initial Preservation Check: 05/24/2024 09:51 MMC

Preservation Recheck (E200.8): N/A

Attention: Tom Wackerman

Address: ASTI Environmental  
10448 Citation Drive  
Suite 100  
Brighton, MI 48116

Phone: 810-599-5463      FAX:

Email: [twacker@asti-env.com](mailto:twacker@asti-env.com)

Sample ID	Bottle / Preservation	pH (Orig)	Add ml	pH (New)	Notes
S62474.11	125mL Plastic HNO3	<2			
S62474.12	125mL Plastic HNO3	<2			
S62474.13	125mL Plastic HNO3	<2			



2680 East Lansing Dr., East Lansing, MI 48823  
 Phone (517) 332-0167 Fax (517) 332-4034  
 www.meritlabs.com

C.O.C. PAGE # 1 OF 2 171234

**REPORT TO**

**CHAIN OF CUSTODY RECORD**

**INVOICE TO**

CONTACT NAME: Thomas Wackerman / Emily Manetz  
 COMPANY: ASTI Environmental  
 ADDRESS: 10448 Citation Dr  
 CITY: Brighton STATE: MI ZIP CODE: 48116  
 PHONE NO.: 810-599-5463 CELL NO.: 616-485-5743 P.O. NO.:  
 E-MAIL ADDRESS: twacker@asti-env.com / emanetz@asti-env.com QUOTE NO.:

CONTACT NAME:  SAME  
 COMPANY:  
 ADDRESS:  
 CITY: STATE: ZIP CODE:  
 PHONE NO.: E-MAIL ADDRESS:

PROJECT NO./NAME: Hamlin & Adams / 13059-1 SAMPLER(S) - PLEASE PRINT/SIGN NAME: Emily Manetz *EMA*  
 TURNAROUND TIME REQUIRED:  1 DAY  2 DAYS  3 DAYS  STANDARD  OTHER  
 DELIVERABLES REQUIRED:  STD  LEVEL II  LEVEL III  LEVEL IV  EDD  OTHER

ANALYSIS (ATTACH LIST IF MORE SPACE IS REQUIRED)

MATRIX W=WATER GW=GROUNDWATER WW=WASTEWATER S=SOIL L=LIQUID SD=SOLID  
 CODE: SL=SLUDGE DW=DRINKING WATER O=OIL WP=WIPE A=AIR WS=WASTE

# Containers & Preservatives

MERIT LAB NO. <small>FOR LAB USE ONLY</small>	COLLECTION		SAMPLE TAG IDENTIFICATION-DESCRIPTION	MATRIX	# OF BOTTLES	NONE	HCl	HNO <sub>3</sub>	H <sub>2</sub> SO <sub>4</sub>	NaOH	MeOH	OTHER	VOCs	PNAS	MI 10 Metals	PCBs	PFAS	dissolved methane	Certifications		Project Locations		Special Instructions
	DATE	TIME																	<input type="checkbox"/> OHIO VAP	<input type="checkbox"/> Drinking Water	<input type="checkbox"/> DoD	<input type="checkbox"/> NPDES	
62474.01	5/22/24	1600	SB-1 (4-5')	S	6	5							X	X	X	X	X						
.02		1605	SB-1 (10-11')																				
.03		1515	SB-2 (9-10')																				
.04		1520	SB-2 (10-11')																				
.05		1415	SB-3 (9-10')																				
.06		1420	SB-3 (10-11')																				
.07		1300	SB-4 (1.5-2.5')																				
.08		1305	SB-4 (10-11')																				
.09			DUP-1S																				
.10			Meth Blank																				
.11	5/23/24	1145	SB-3-MW	GW	11	5	5	1						X	X	X	X	X					
.12		1338	SB-4-MW											X	X	X	X	X					

RELINQUISHED BY: *EMA*  Sampler DATE: 5/23/24 TIME: 18:20  
 RECEIVED BY: ASTI Cold Storage DATE: 5/23/24 TIME: 18:20  
 RELINQUISHED BY: ASTI Cold Storage DATE: 5/24/24 TIME: 805  
 RECEIVED BY: *B/B* DATE: 5/24/24 TIME: 805

RELINQUISHED BY: *B/B* DATE: 5/24/24 TIME: 900  
 RECEIVED BY: M Chilcote DATE: 5/24/24 TIME: 0900  
 SEAL NO.: SEAL INTACT: YES  NO  INITIALS:  
 SEAL NO.: SEAL INTACT: YES  NO  INITIALS:  
 NOTES: TEMP. ON ARRIVAL: 6.0



2680 East Lansing Dr., East Lansing, MI 48823  
 Phone (517) 332-0167 Fax (517) 332-4034  
 www.meritlabs.com

C.O.C. PAGE # 2 OF 2 171235

**REPORT TO**

**CHAIN OF CUSTODY RECORD**

**INVOICE TO**

CONTACT NAME Thomas Wackerman / Emily Manetz  
 COMPANY ASTI Environmental  
 ADDRESS 10448 Citation Dr  
 CITY Brighton STATE MI ZIP CODE 48116  
 PHONE NO. 810-599-5463 / 616-485-5743 CELL NO. P.O. NO.  
 E-MAIL ADDRESS twacker@asti-env.com / emanetz@asti-env.com QUOTE NO.

CONTACT NAME  SAME  
 COMPANY  
 ADDRESS  
 CITY STATE ZIP CODE  
 PHONE NO. E-MAIL ADDRESS

PROJECT NO./NAME Hamlin & Adams / 13059-1 SAMPLER(S) - PLEASE PRINT/SIGN NAME EM  
 TURNAROUND TIME REQUIRED  1 DAY  2 DAYS  3 DAYS  STANDARD  OTHER  
 DELIVERABLES REQUIRED  STD  LEVEL II  LEVEL III  LEVEL IV  EDD  OTHER

ANALYSIS (ATTACH LIST IF MORE SPACE IS REQUIRED)

MATRIX W=WATER GW=GROUNDWATER WW=WASTEWATER S=SOIL L=LIQUID SD=SOLID  
 CODE: SL=SLUDGE DW=DRINKING WATER O=OIL WP=WIPE A=AIR WS=WASTE

# Containers & Preservatives  
 VOCs PNAS MI 10 Metals PCBs PFAS dissolved methane

Certifications  
 OHIO VAP  Drinking Water  
 DoD  NPDES  
 Project Locations  
 Detroit  New York  
 Other  
 Special Instructions

MERIT LAB NO. <small>FOR LAB USE ONLY</small>	COLLECTION		SAMPLE TAG IDENTIFICATION-DESCRIPTION	MATRIX	# OF BOTTLES	NONE	HCl	HNO <sub>3</sub>	H <sub>2</sub> SO <sub>4</sub>	NaOH	MeOH	OTHER	VOCs	PNAS	MI 10 Metals	PCBs	PFAS	dissolved methane
	DATE	TIME																
62474.13	5/23/24	—	DUP-1GW	GW	11	5	5	1					X	X	X	X	X	X

RELINQUISHED BY: EM  Sampler DATE 5/23/24 TIME 18:20  
 RECEIVED BY: ASTI Cold Storage DATE 5/23/24 TIME 18:20  
 RELINQUISHED BY: ASTI Cold Storage DATE 5/24/24 TIME 8:00  
 RECEIVED BY: EM DATE 5/27/24 TIME 8:00

RELINQUISHED BY: EM DATE 5/24/24 TIME 9:00  
 RECEIVED BY: M Chilcote DATE 5/24/24 TIME 0900  
 SEAL NO. SEAL INTACT YES  NO  INITIALS  
 NOTES: TEMP. ON ARRIVAL 6.0

PLEASE NOTE: SIGNING ACKNOWLEDGES ADHERENCE TO MERIT'S SAMPLE ACCEPTANCE POLICY ON REVERSE SIDE

 **ANALYTICAL REPORT****PREPARED FOR**

Attn: Lab Results  
Merit Laboratories  
2680 E Lansing Drive  
East Lansing, Michigan 48823

Generated 5/28/2024 11:23:20 PM

**JOB DESCRIPTION**

Merit Laboratories

**JOB NUMBER**

190-34516-1



# Eurofins Michigan

## Job Notes

This report may not be reproduced except in full, and with written approval from the laboratory. The results relate only to the samples tested. For questions please contact the Project Manager at the e-mail address or telephone number listed on this page.

The test results in this report relate only to the samples as received by the laboratory and will meet all requirements of the methodology, with any exceptions noted. This report shall not be reproduced except in full, without the express written approval of the laboratory. All questions should be directed to the Eurofins Environment Testing North Central, LLC Project Manager.

## Authorization



Generated  
5/28/2024 11:23:20 PM

Authorized for release by  
Sue Schafer, Project Manager II  
[Sue.Schafer@et.eurofinsus.com](mailto:Sue.Schafer@et.eurofinsus.com)  
(810)229-2763



# Table of Contents

Cover Page . . . . .	1
Table of Contents . . . . .	3
Sample Summary . . . . .	4
Case Narrative . . . . .	5
Client Sample Results . . . . .	6
QC Sample Results . . . . .	7
Definitions/Glossary . . . . .	8
QC Association Summary . . . . .	9
Lab Chronicle . . . . .	10
Certification Summary . . . . .	11
Method Summary . . . . .	12
Chain of Custody . . . . .	13

# Sample Summary

Client: Merit Laboratories  
Project/Site: Merit Laboratories

Job ID: 190-34516-1

---

Lab Sample ID	Client Sample ID	Matrix	Collected	Received
190-34516-1	SB-3-MW	Water	05/23/24 11:45	05/24/24 16:18
190-34516-2	SB-4-MW	Water	05/23/24 13:38	05/24/24 16:18
190-34516-3	DUP-1-GW	Water	05/23/24 00:00	05/24/24 16:18

1

2

3

4

5

6

7

8

9

10

11

12

# Case Narrative

Client: Merit Laboratories  
Project: Merit Laboratories

Job ID: 190-34516-1

**Job ID: 190-34516-1**

**Eurofins Michigan**

## Job Narrative 190-34516-1

Analytical test results meet all requirements of the associated regulatory program listed on the Accreditation/Certification Summary Page unless otherwise noted under the individual analysis. Data qualifiers are applied to indicate exceptions. Noncompliant quality control (QC) is further explained in narrative comments.

- Matrix QC may not be reported if insufficient sample or site-specific QC samples were not submitted. In these situations, to demonstrate precision and accuracy at a batch level, a LCS/LCSD may be performed, unless otherwise specified in the method.
- Surrogate and/or isotope dilution analyte recoveries (if applicable) which are outside of the QC window are confirmed unless attributed to a dilution or otherwise noted in the narrative.

Regulated compliance samples (e.g. SDWA, NPDES) must comply with the associated agency requirements/permits.

### Receipt

The samples were received on 5/24/2024 4:18 PM. Unless otherwise noted below, the samples arrived in good condition, and, where required, properly preserved and on ice.

### GC VOA

No additional analytical or quality issues were noted, other than those described above or in the Definitions/ Glossary page.

Eurofins Michigan

# Client Sample Results

Client: Merit Laboratories  
 Project/Site: Merit Laboratories

Job ID: 190-34516-1

**Client Sample ID: SB-3-MW**

**Lab Sample ID: 190-34516-1**

Date Collected: 05/23/24 11:45

Matrix: Water

Date Received: 05/24/24 16:18

**Method: RSK-175 - Dissolved Gases (GC)**

Analyte	Result	Qualifier	RL	Unit	D	Prepared	Analyzed	Dil Fac
Methane	18		1.0	ug/L			05/28/24 00:08	1
Surrogate	%Recovery	Qualifier	Limits			Prepared	Analyzed	Dil Fac
1,1,1-Trifluoroethane	94		60 - 140				05/28/24 00:08	1

**Client Sample ID: SB-4-MW**

**Lab Sample ID: 190-34516-2**

Date Collected: 05/23/24 13:38

Matrix: Water

Date Received: 05/24/24 16:18

**Method: RSK-175 - Dissolved Gases (GC)**

Analyte	Result	Qualifier	RL	Unit	D	Prepared	Analyzed	Dil Fac
Methane	48		1.0	ug/L			05/28/24 00:25	1
Surrogate	%Recovery	Qualifier	Limits			Prepared	Analyzed	Dil Fac
1,1,1-Trifluoroethane	94		60 - 140				05/28/24 00:25	1

**Client Sample ID: DUP-1-GW**

**Lab Sample ID: 190-34516-3**

Date Collected: 05/23/24 00:00

Matrix: Water

Date Received: 05/24/24 16:18

**Method: RSK-175 - Dissolved Gases (GC)**

Analyte	Result	Qualifier	RL	Unit	D	Prepared	Analyzed	Dil Fac
Methane	17		1.0	ug/L			05/28/24 00:43	1
Surrogate	%Recovery	Qualifier	Limits			Prepared	Analyzed	Dil Fac
1,1,1-Trifluoroethane	94		60 - 140				05/28/24 00:43	1

# QC Sample Results

Client: Merit Laboratories  
 Project/Site: Merit Laboratories

Job ID: 190-34516-1

## Method: RSK-175 - Dissolved Gases (GC)

Lab Sample ID: MB 240-614459/32

Matrix: Water

Analysis Batch: 614459

Client Sample ID: Method Blank

Prep Type: Total/NA

Analyte	MB Result	MB Qualifier	RL	Unit	D	Prepared	Analyzed	Dil Fac
Methane	<1.0		1.0	ug/L			05/27/24 18:45	1
Surrogate	MB %Recovery	MB Qualifier	Limits			Prepared	Analyzed	Dil Fac
1,1,1-Trifluoroethane	98		60 - 140				05/27/24 18:45	1

Lab Sample ID: LCS 240-614459/33

Matrix: Water

Analysis Batch: 614459

Client Sample ID: Lab Control Sample

Prep Type: Total/NA

Analyte	Spike Added	LCS Result	LCS Qualifier	Unit	D	%Rec	%Rec Limits
Methane	284	284		ug/L		100	80 - 120
Surrogate	LCS %Recovery	LCS Qualifier	Limits				
1,1,1-Trifluoroethane	97		60 - 140				

## Definitions/Glossary

Client: Merit Laboratories  
Project/Site: Merit Laboratories

Job ID: 190-34516-1

### Glossary

Abbreviation	These commonly used abbreviations may or may not be present in this report.
▫	Listed under the "D" column to designate that the result is reported on a dry weight basis
%R	Percent Recovery
CFL	Contains Free Liquid
CFU	Colony Forming Unit
CNF	Contains No Free Liquid
DER	Duplicate Error Ratio (normalized absolute difference)
Dil Fac	Dilution Factor
DL	Detection Limit (DoD/DOE)
DL, RA, RE, IN	Indicates a Dilution, Re-analysis, Re-extraction, or additional Initial metals/anion analysis of the sample
DLC	Decision Level Concentration (Radiochemistry)
EDL	Estimated Detection Limit (Dioxin)
LOD	Limit of Detection (DoD/DOE)
LOQ	Limit of Quantitation (DoD/DOE)
MCL	EPA recommended "Maximum Contaminant Level"
MDA	Minimum Detectable Activity (Radiochemistry)
MDC	Minimum Detectable Concentration (Radiochemistry)
MDL	Method Detection Limit
ML	Minimum Level (Dioxin)
MPN	Most Probable Number
MQL	Method Quantitation Limit
NC	Not Calculated
ND	Not Detected at the reporting limit (or MDL or EDL if shown)
NEG	Negative / Absent
POS	Positive / Present
PQL	Practical Quantitation Limit
PRES	Presumptive
QC	Quality Control
RER	Relative Error Ratio (Radiochemistry)
RL	Reporting Limit or Requested Limit (Radiochemistry)
RPD	Relative Percent Difference, a measure of the relative difference between two points
TEF	Toxicity Equivalent Factor (Dioxin)
TEQ	Toxicity Equivalent Quotient (Dioxin)
TNTC	Too Numerous To Count

# QC Association Summary

Client: Merit Laboratories  
Project/Site: Merit Laboratories

Job ID: 190-34516-1

## GC VOA

### Analysis Batch: 614459

Lab Sample ID	Client Sample ID	Prep Type	Matrix	Method	Prep Batch
190-34516-1	SB-3-MW	Total/NA	Water	RSK-175	
190-34516-2	SB-4-MW	Total/NA	Water	RSK-175	
190-34516-3	DUP-1-GW	Total/NA	Water	RSK-175	
MB 240-614459/32	Method Blank	Total/NA	Water	RSK-175	
LCS 240-614459/33	Lab Control Sample	Total/NA	Water	RSK-175	

- 1
- 2
- 3
- 4
- 5
- 6
- 7
- 8
- 9
- 10
- 11
- 12



# Lab Chronicle

Client: Merit Laboratories  
Project/Site: Merit Laboratories

Job ID: 190-34516-1

## Client Sample ID: SB-3-MW

Lab Sample ID: 190-34516-1

Date Collected: 05/23/24 11:45

Matrix: Water

Date Received: 05/24/24 16:18

Prep Type	Batch Type	Batch Method	Run	Dilution Factor	Batch Number	Analyst	Lab	Prepared or Analyzed
Total/NA	Analysis	RSK-175		1	614459	JBN	EET CLE	05/28/24 00:08

## Client Sample ID: SB-4-MW

Lab Sample ID: 190-34516-2

Date Collected: 05/23/24 13:38

Matrix: Water

Date Received: 05/24/24 16:18

Prep Type	Batch Type	Batch Method	Run	Dilution Factor	Batch Number	Analyst	Lab	Prepared or Analyzed
Total/NA	Analysis	RSK-175		1	614459	JBN	EET CLE	05/28/24 00:25

## Client Sample ID: DUP-1-GW

Lab Sample ID: 190-34516-3

Date Collected: 05/23/24 00:00

Matrix: Water

Date Received: 05/24/24 16:18

Prep Type	Batch Type	Batch Method	Run	Dilution Factor	Batch Number	Analyst	Lab	Prepared or Analyzed
Total/NA	Analysis	RSK-175		1	614459	JBN	EET CLE	05/28/24 00:43

## Client Sample ID: Method Blank

Lab Sample ID: MB 240-614459/32

Date Collected: N/A

Matrix: Water

Date Received: N/A

Prep Type	Batch Type	Batch Method	Run	Dilution Factor	Batch Number	Analyst	Lab	Prepared or Analyzed
Total/NA	Analysis	RSK-175		1	614459	JBN	EET CLE	05/27/24 18:45

## Client Sample ID: Lab Control Sample

Lab Sample ID: LCS 240-614459/33

Date Collected: N/A

Matrix: Water

Date Received: N/A

Prep Type	Batch Type	Batch Method	Run	Dilution Factor	Batch Number	Analyst	Lab	Prepared or Analyzed
Total/NA	Analysis	RSK-175		1	614459	JBN	EET CLE	05/27/24 19:02

### Laboratory References:

EET CLE = Eurofins Cleveland, 180 S. Van Buren Avenue, Barberton, OH 44203, TEL (330)497-9396

### Analyst References:

Lab: EET CLE

Batch Type: Analysis

JBN = Jeffrey Nestor

# Accreditation/Certification Summary

Client: Merit Laboratories  
Project/Site: Merit Laboratories

Job ID: 190-34516-1

## Laboratory: Eurofins Cleveland

All accreditations/certifications held by this laboratory are listed. Not all accreditations/certifications are applicable to this report.

Authority	Program	Identification Number	Expiration Date
California	State	2927	02-28-25
Georgia	State	4062	02-27-25
Illinois	NELAP	200004	07-31-24
Iowa	State	421	06-01-25
Kentucky (UST)	State	112225	02-27-25
Kentucky (WW)	State	KY98016	12-30-24
Minnesota	NELAP	039-999-348	12-31-24
New Jersey	NELAP	OH001	06-30-24
New York	NELAP	10975	04-02-25
Ohio VAP	State	ORELAP 4062	02-27-25
Oregon	NELAP	4062	02-27-25
Pennsylvania	NELAP	68-00340	08-31-24
Texas	NELAP	T104704517-22-19	08-31-24
USDA	US Federal Programs	P330-18-00281	01-05-27
Virginia	NELAP	460175	09-14-24
West Virginia DEP	State	210	12-31-24

# Method Summary

Client: Merit Laboratories  
Project/Site: Merit Laboratories

Job ID: 190-34516-1

Method	Method Description	Protocol	Laboratory
RSK-175	Dissolved Gases (GC)	RSK	EET CLE

**Protocol References:**

RSK = Sample Prep And Calculations For Dissolved Gas Analysis In Water Samples Using A GC Headspace Equilibration Technique , RSKSOP-175, Rev. 0, 8/11/94, USEPA Research Lab

**Laboratory References:**

EET CLE = Eurofins Cleveland, 180 S. Van Buren Avenue, Barberton, OH 44203, TEL (330)497-9396





2680 East Lansing Dr., East Lansing, MI 48823  
 Phone (517) 332-0167 Fax (517) 332-4034  
 www.meritlabs.com

C.O.C. PAGE # 1 OF 1

**REPORT TO**

**CHAIN OF CUSTODY RECORD**

**INVOICE TO**

CONTACT NAME **Project Management Team**  
 COMPANY **Merit Laboratories**  
 ADDRESS **2680 East Lansing Drive**  
 CITY **East Lansing** STATE **MI** ZIP CODE **48823**  
 PHONE NO. **517-332-0167** FAX NO. \_\_\_\_\_ P.O. NO. \_\_\_\_\_  
 E-MAIL ADDRESS **results@meritlabs.com** QUOTE NO. \_\_\_\_\_

CONTACT NAME **Julie Teague**  SAME  
 COMPANY **Merit Laboratories**  
 ADDRESS **2680 East Lansing Drive**  
 CITY **East Lansing** STATE **MI** ZIP CODE **48823**  
 PHONE NO. **517-332-0167** E-MAIL ADDRESS **juliet@meritlabs.com**

PROJECT NO./NAME **Hamlin K Adams/13059-1** SAMPLER(S) - PLEASE PRINT/SIGN NAME \_\_\_\_\_  
 TURNAROUND TIME REQUIRED  1 DAY  2 DAYS  3 DAYS  STANDARD  OTHER \_\_\_\_\_  
 DELIVERABLES REQUIRED  STD  LEVEL II  LEVEL III  LEVEL IV  EDD  OTHER \_\_\_\_\_

MATRIX CODE: GW=GROUNDWATER WW=WASTEWATER S=SOIL L=LIQUID SD=SOLID  
 SL=SLUDGE DW=DRINKING WATER O=OIL WP=WIPE A=AIR W=WASTE

# Containers & Preservatives

MERIT LAB NO. <small>FOR LAB USE ONLY</small>	YEAR <b>24</b>		SAMPLE TAG IDENTIFICATION-DESCRIPTION	MATRIX	# OF BOTTLES	NONE	HCl	HNO <sub>3</sub>	H <sub>2</sub> SO <sub>4</sub>	NaOH	MeOH	OTHER
	DATE	TIME										
	5/23	1145	SB-3-MW	GW	3		3					
	↓	1338	SB-4-MW	↓	↓		↓					
	↓	-	Dup-1 GW	↓	↓		↓					

dissolved Methane

Certifications  
 OHIO VAP  Drinking Water  
 DoD  NPDES  
 Project Locations  
 Detroit  New York  
 Other \_\_\_\_\_  
 Special Instructions



190-34516 Chain of Custody

RELINQUISHED BY: **[Signature]**  Sampler DATE **5/24/24** TIME **10:25**  
 RECEIVED BY: **[Signature]** DATE **5/24/24** TIME **10:25**  
 RELINQUISHED BY: \_\_\_\_\_ DATE \_\_\_\_\_ TIME \_\_\_\_\_  
 RECEIVED BY: \_\_\_\_\_ DATE \_\_\_\_\_ TIME \_\_\_\_\_

RELINQUISHED BY: **[Signature]** DATE **5/24/24** TIME **10:45**  
 RECEIVED BY: **JESSICA RIGDON** DATE **5-25-24** TIME **08:00**  
 SEAL NO. SEAL INTACT YES  NO  INITIALS \_\_\_\_\_ NOTES: TEMP. ON ARRIVAL \_\_\_\_\_  
 SEAL NO. SEAL INTACT YES  NO  INITIALS \_\_\_\_\_

PLEASE NOTE: SIGNING ACKNOWLEDGES ADHERENCE TO MERIT'S SAMPLE ACCEPTANCE POLICY ON REVERSE SIDE

**Eurofins Michigan**

10448 Citation Drive Suite 200  
 Brighton, MI 48116  
 Phone: 810-229-2763 Fax: 810-229-0000

**Chain of Custody Record**



<b>Client Information (Sub Contract Lab)</b>				Sampler:		Lab PM: Schafer, Sue		Carrier Tracking No(s):		COC No: 190-39295.1			
Client Contact: Shipping/Receiving				Phone:		E-Mail: Sue.Schafer@et.eurofinsus.com		State of Origin: Michigan		Page: Page 1 of 1			
Company: Eurofins Environment Testing North Cent				Accreditations Required (See note):				Job #: 190-34516-1					
Address: 180 S. Van Buren Avenue,				Due Date Requested: 6/6/2024		<b>Analysis Requested</b>						Preservation Codes: -	
City: Barberton				TAT Requested (days):									
State, Zip: OH, 44203				PO #:									
Phone: 330-497-9396(Tel) 330-497-0772(Fax)				WO #:									
Email:				Project #: 19001249									
Project Name: Merit Laboratories				SSOW#:		<b>Other:</b>							
Site:													
<b>Sample Identification - Client ID (Lab ID)</b>				<b>Sample Date</b>		<b>Sample Time</b>		<b>Sample Type (C=Comp, G=grab)</b>		<b>Matrix (W=water, S=solid, O=waste/oil, BT=Tissue, A=Air)</b>			
										<b>Special Instructions/Note:</b>  <span style="font-size: 2em; font-family: cursive;">RSIC</span>			
SB-3-MW (190-34516-1)				5/23/24		11:45 Eastern		Water		3			
SB-4-MW (190-34516-2)				5/23/24		13:38 Eastern		Water		3			
DUP-1-GW (190-34516-3)				5/23/24		Eastern		Water		3			

Note: Since laboratory accreditations are subject to change, Eurofins Environment Testing North Central, LLC places the ownership of method, analyte & accreditation compliance upon our subcontract laboratories. This sample shipment is forwarded under chain-of-custody. If the laboratory does not currently maintain accreditation in the State of Origin listed above for analysis/tests/matrix being analyzed, the samples must be shipped back to the Eurofins Environment Testing North Central, LLC laboratory or other instructions will be provided. Any changes to accreditation status should be brought to Eurofins Environment Testing North Central, LLC attention immediately. If all requested accreditations are current to date, return the signed Chain of Custody attesting to said compliance to Eurofins Environment Testing North Central, LLC.

<b>Possible Hazard Identification</b>				<b>Sample Disposal ( A fee may be assessed if samples are retained longer than 1 month)</b>							
Unconfirmed				<input type="checkbox"/> Return To Client <input type="checkbox"/> Disposal By Lab <input type="checkbox"/> Archive For _____ Months							
Deliverable Requested: I, II, III, IV, Other (specify)				Primary Deliverable Rank: 2				Special Instructions/QC Requirements:			

Empty Kit Relinquished by:		Date:		Time:		Method of Shipment:				
Relinquished by: <i>[Signature]</i>		Date/Time: 5/24/24 1700		Company: EENT		Received by: JESSICA RIGDON		Date/Time: 5-25-24 0800		Company: EENT
Relinquished by:		Date/Time:		Company:		Received by:		Date/Time:		Company:
Relinquished by:		Date/Time:		Company:		Received by:		Date/Time:		Company:



Eurofins - Cleveland Sample Receipt Form/Narrative  
 Barberton Facility  
 Login # \_\_\_\_\_

Client Eurofins - ME Site Name \_\_\_\_\_ Cooler unpacked by: me

Cooler Received on 5-25-24 Opened on 5-25-24  
 FedEx. 1<sup>st</sup> Grd Exp UPS FAS Waypoint Client Drop Off Eurofins Courier Other \_\_\_\_\_

Receipt After-hours Drop-off Date/Time \_\_\_\_\_ Storage Location \_\_\_\_\_  
 Eurofins Cooler # EC Foam Box Client Cooler Box Other \_\_\_\_\_  
 Packing material used. Bubble Wrap Foam Plastic Bag None Other \_\_\_\_\_  
 COOLANT Wet Ice Blue Ice Dry Ice Water None \_\_\_\_\_

1 Cooler temperature upon receipt  See Multiple Cooler Form  
 IR GUN # 18 (CR) 0.0 °C Observed Cooler Temp. 11 °C Corrected Cooler Temp. 1.1 °C

2. Were tamper/custody seals on the outside of the cooler(s)? If Yes Quantity 1  
 -Were the seals on the outside of the cooler(s) signed & dated?  Yes  No  NA  
 -Were tamper/custody seals on the bottle(s) or bottle kits (LLHg/MeHg)?  Yes  No  NA  
 -Were tamper/custody seals intact and uncompromised?  Yes  No  NA  
 3 Shippers' packing slip attached to the cooler(s)?  Yes  No  
 4 Did custody papers accompany the sample(s)?  Yes  No  
 5 Were the custody papers relinquished & signed in the appropriate place?  Yes  No  
 6 Was/were the person(s) who collected the samples clearly identified on the COC?  Yes  No  
 7 Did all bottles arrive in good condition (Unbroken)?  Yes  No  
 8 Could all bottle labels (ID/Date/Time) be reconciled with the COC?  Yes  No  
 9 For each sample, does the COC specify preservatives (Y/N), # of containers (Y/N), and sample type of grab/comp (Y/N)?  Yes  No  
 10 Were correct bottle(s) used for the test(s) indicated?  Yes  No  
 11 Sufficient quantity received to perform indicated analyses?  Yes  No  
 12. Are these work share samples and all listed on the COC?  Yes  No  
 If yes, Questions 13-17 have been checked at the originating laboratory

Tests that are not checked for pH by Receiving:  
 VOAs  
 Oil and Grease  
 TOC

13 Were all preserved sample(s) at the correct pH upon receipt?  Yes  No  NA pH Strip Lot# HC339814  
 14. Were VOAs on the COC?  Yes  No  
 15 Were air bubbles >6 mm in any VOA vials?  Yes  No  NA  
 16. Was a VOA trip blank present in the cooler(s)? Trip Blank Lot # \_\_\_\_\_  Yes  No  
 17 Was a LL Hg or Me Hg trip blank present?  Yes  No  
 Contacted PM \_\_\_\_\_ Date \_\_\_\_\_ by \_\_\_\_\_ via Verbal Voice Mail Other \_\_\_\_\_  
 Concerning \_\_\_\_\_

18. CHAIN OF CUSTODY & SAMPLE DISCREPANCIES  additional next page Samples processed by \_\_\_\_\_

19. SAMPLE CONDITION  
 Sample(s) \_\_\_\_\_ were received after the recommended holding time had expired  
 Sample(s) \_\_\_\_\_ were received in a broken container  
 Sample(s) \_\_\_\_\_ were received with bubble >6 mm in diameter (Notify PM)

20. SAMPLE PRESERVATION  
 Sample(s) \_\_\_\_\_ were further preserved in the laboratory  
 Time preserved \_\_\_\_\_ Preservative(s) added/Lot number(s) \_\_\_\_\_  
 VOA Sample Preservation - Date/Time VOAs Frozen. \_\_\_\_\_



# Analytical Laboratory Report

Report ID: S62472.01(01)  
Generated on 06/06/2024

## Report to

---

Attention: Tom Wackerman  
ASTI Environmental  
10448 Citation Drive  
Suite 100  
Brighton, MI 48116

Phone: 810-599-5463 FAX:  
Email: twacker@asti-env.com

Additional Contacts: Brad Buswell, Emily Manetz

## Report produced by

---

Merit Laboratories, Inc.  
2680 East Lansing Drive  
East Lansing, MI 48823

Phone: (517) 332-0167 FAX: (517) 332-6333

## Contacts for report questions:

John Lavery (johnlavery@meritlabs.com)  
Barbara Ball (bball@meritlabs.com)

## Report Summary

---

Lab Sample ID(s): S62472.01  
Project: 13059-1 Waste Char.  
Collected Date(s): 05/22/2024  
Submitted Date/Time: 05/24/2024 09:00  
Sampled by: Emily Manetz  
P.O. #:

## Table of Contents

---

Cover Page (Page 1)  
General Report Notes (Page 2)  
Report Narrative (Page 2)  
Laboratory Accreditations (Page 3)  
Qualifier Descriptions (Page 3)  
Glossary of Abbreviations (Page 3)  
Method Summary (Page 4)  
Sample Summary (Page 5)

Maya Murshak  
Technical Director



# Analytical Laboratory Report

## General Report Notes

---

Analytical results relate only to the samples tested, in the condition received by the laboratory.

Methods may be modified for improved performance.

Results reported on a dry weight basis where applicable.

'Not detected' indicates that parameter was not found at a level equal to or greater than the reporting limit (RL).

When MDL results are provided, then 'Not detected' indicates that parameter was not found at a level equal to or greater than the MDL.

40 CFR Part 136 Table II Required Containers, Preservation Techniques and Holding Times for the Clean Water Act specify that samples for acrolein and acrylonitrile, and 2-chloroethylvinyl ether need to be preserved at a pH in the range of 4 to 5 or if not preserved, analyzed within 3 days of sampling.

QA/QC corresponding to this analytical report is a separate document with the same Merit ID reference and is available upon request.

Starred (\*) analytes are not NY NELAP accredited.

Samples are held by the lab for 30 days from the final report date unless a written request to hold longer is provided by the client.

Report shall not be reproduced except in full, without the written approval of Merit Laboratories, Inc.

Limits for drinking water samples, are listed as the MCL Limits (Maximum Contaminant Level Concentrations)

PFAS requirement: Section 9.3.8 of U.S. EPA Method 537.1 states "If the method analyte(s) found in the Field Sample is present in the

FRB at a concentration greater than 1/3 the MRL, then all samples collected with that FRB are invalid and must be recollected and reanalyzed."

Samples submitted without an accompanying FRB may not be acceptable for compliance purposes.

Wisconsin PFAs analysis: MDL = LOD; RL = LOQ. LOD and LOQ are adjusted for dilution.

All accreditations/certifications held by this laboratory are listed on page 3. Not all accreditations/certifications are applicable to this report.

For a specific list of accredited analytes, please feel free to contact the laboratory or visit <https://www.meritlabs.com/certifications>.

## Report Narrative

---

There is no additional narrative for this analytical report





# Analytical Laboratory Report

## Laboratory Accreditations (For Reference Only)

Authority	Accreditation ID
Michigan DEQ	#9956
DOD ELAP & ISO/IEC 17025:2017	#69699 PJLA Testing
WBENC	#2005110032
Ohio VAP	#CL0002
Indiana DOH	#C-MI-07
New York NELAC	#11814
North Carolina DENR	#680
North Carolina DOH	#26702
Pennsylvania DEP	#68-05884
Wisconsin DNR	FID# 399147320

## Qualifier Descriptions

Qualifier	Description
!	Result is outside of stated limit criteria
B	Compound also found in associated method blank
E	Concentration exceeds calibration range
F	Analysis run outside of holding time
G	Estimated result due to extraction run outside of holding time
H	Sample submitted and run outside of holding time
I	Matrix interference with internal standard
J	Estimated value less than reporting limit, but greater than MDL
L	Elevated reporting limit due to low sample amount
M	Result reported to MDL not RDL
O	Analysis performed by outside laboratory. See attached report.
R	Preliminary result
S	Surrogate recovery outside of control limits
T	No correction for total solids
X	Elevated reporting limit due to matrix interference
Y	Elevated reporting limit due to high target concentration
b	Value detected less than reporting limit, but greater than MDL
e	Reported value estimated due to interference
j	Analyte also found in associated method blank
o	Associated EIS outside of control limits
p	Benzo(b)Fluoranthene and Benzo(k)Fluoranthene integrated as one peak.
q	Qualifier ion ratio outside of control limits
x	Preserved from bulk sample

## Glossary of Abbreviations

Abbreviation	Description
RL/RDL	Reporting Limit
MDL	Method Detection Limit
MS	Matrix Spike
MSD	Matrix Spike Duplicate
SW	EPA SW 846 (Soil and Wastewater) Methods
E	EPA Methods
SM	Standard Methods
LN	Linear
BR	Branched



# Analytical Laboratory Report

## Method Summary

Method	Version
SM2540B	Standard Method 2540 B 2015
SW1030	SW 846 Method 1030 Revision 0 December 1996
SW1311	SW 846 Method 1311 Revision 0 July 1992
SW3015A	SW 846 Method 3015A Revision 1 February 2007
SW3510C	SW 846 Method 3510C Revision 3 December 1996
SW3535A	SW 846 Method 3535A Revision 1 February 2007
SW3546	SW 846 Method 3546 Revision 0 February 2007
SW5030C/8260C	SW 846 Method 8260C Revision 3 August 2006 / 5030C Revision 3 May 2003
SW6020A	SW 846 Method 6020A Revision 1 February 2007
SW7471B	SW 846 Method 7471B Revision 2 February 2007
SW8081B	SW 846 Method 8081B Revision 2 February 2007
SW8082A	SW 846 Method 8082A Revision 1 February 2007
SW8151A	SW 846 Method 8151A Revision 1 December 1996
SW8270D	SW 846 Method 8270D Revision 4 February 2007
SW9010B	SW 846 Method 9010B Revision 2 December 1996
SW9030B	SW 846 Method 9030B Revision 2 December 1996
SW9045D	SW 846 Method 9045D Revision 4 November 2004



# Analytical Laboratory Report

## Sample Summary (1 samples)

Sample ID	Sample Tag	Matrix	Collected Date/Time
S62472.01	SC-1	Soil	05/22/24 16:20



# Analytical Laboratory Report

Lab Sample ID: S62472.01

Sample Tag: SC-1

Collected Date/Time: 05/22/2024 16:20

Matrix: Soil

COC Reference: 171236

Sample Containers

#	Type	Preservative(s)	Refrigerated?	Arrival Temp. (C)	Thermometer #
4	4oz Glass	None	Yes	6.0	IR

**Extraction / Prep.**

Parameter	Result	Method	Run Date	Analyst	Flags
TCLP Zero Headspace Ext.	Completed	SW1311	05/29/24 16:00	DMP	
Metal Digestion*	Completed	SW3015A	05/31/24 14:10	CCM	
Pesticides Extraction*	Completed	SW3510C	06/04/24 15:00	JWR	
TCLP/SPLP BNA Extraction*	Completed	SW3535A	05/31/24 09:00	JW	
Extraction, PCB*	Completed	SW3546	05/28/24 12:30	DJS	
Mercury Digestion	Completed	SW7471B	05/30/24 12:26	CTV	

**TCLP Extraction**

Parameter	Result	Method	Run Date	Analyst	Flags
Initial Sample pH	9.12	SW1311	05/29/24 16:00 - 05/30/24	DMP	
pH after 3.5 ml HCl	2.01	SW1311	05/29/24 16:00 - 05/30/24	DMP	
% Solids	100	SW1311	05/29/24 16:00 - 05/30/24	DMP	
Sample Used g	100	SW1311	05/29/24 16:00 - 05/30/24	DMP	
Final Volume mL	2000	SW1311	05/29/24 16:00 - 05/30/24	DMP	
TCLP Extraction Fluid	1	SW1311	05/29/24 16:00 - 05/30/24	DMP	
Final Extract pH	7.54	SW1311	05/29/24 16:00 - 05/30/24	DMP	

**Inorganics**

**Method: SM2540B, Run Date: 05/28/24 12:48, Analyst: MAM**

Parameter	Result	RL	MDL	Units	Dilution	CAS#	Flags	Limits
Total Solids*	93	1		%	1			

**Method: SW1030, Run Date: 05/28/24 14:00, Analyst: PL**

Parameter	Result	RL	MDL	Units	Dilution	CAS#	Flags	Limits
Flashpoint for Solids	Not detected	2.2		mm/sec	1			

**Method: SW9010B, Run Date: 06/04/24 17:28, Analyst: MDG**

Parameter	Result	RL	MDL	Units	Dilution	CAS#	Flags	Limits
Reactive Cyanide*	Not detected	0.047		mg/kg	23.4	57-12-5	1	

**Method: SW9030B, Run Date: 06/03/24 16:45, Analyst: MDG**

Parameter	Result	RL	MDL	Units	Dilution	CAS#	Flags	Limits
Reactive Sulfide*	0.79	0.48		mg/kg	23.8	18496-25-8	2	

**Method: SW9045D, Run Date: 05/30/24 13:19, Analyst: SRH**

Parameter	Result	RL	MDL	Units	Dilution	CAS#	Flags	Limits
pH/ Corrosivity	8.54	0.01		STD Units	1			2-12.5

1-\* Total CN- < 0.047 mg/kg

2-\* Total Sulfide = 0.79 mg/kg



# Analytical Laboratory Report

Lab Sample ID: S62472.01 (continued)

Sample Tag: SC-1

### Metals

Method: SW6020A, Run Date: 05/31/24 15:58, Analyst: CCM

Parameter	Result	RL	MDL	Units	Dilution	CAS#	Flags	Limits
Arsenic, TCLP	Not detected	0.02		mg/L	25	7440-38-2		5.0
Barium, TCLP	0.20	0.05		mg/L	25	7440-39-3		100.0
Cadmium, TCLP	Not detected	0.005		mg/L	25	7440-43-9		1.0
Chromium, TCLP	Not detected	0.05		mg/L	25	7440-47-3		5.0
Lead, TCLP	Not detected	0.03		mg/L	25	7439-92-1		5.0
Selenium, TCLP	Not detected	0.05		mg/L	25	7782-49-2		1.0
Silver, TCLP	Not detected	0.005		mg/L	25	7440-22-4		5.0

Method: SW7471B, Run Date: 05/30/24 15:08, Analyst: CTV

Parameter	Result	RL	MDL	Units	Dilution	CAS#	Flags	Limits
Mercury, TCLP	Not detected	0.0005		mg/L	2	7439-97-6		0.2

### Organics - PCBs/Pesticides

TCLP Pesticides, Method: SW8081B, Run Date: 06/05/24 15:41, Analyst: JANB

Parameter	Result	RL	MDL	Units	Dilution	CAS#	Flags	Limits
Chlordane	Not detected	20		ug/L	1	57-74-9		30
Endrin	Not detected	15		ug/L	1	72-20-8		20
Heptachlor	Not detected	6		ug/L	1	76-44-8		8
g-BHC (Lindane)	Not detected	300		ug/L	1	58-89-9		400
Methoxychlor	Not detected	7,000		ug/L	1	72-43-5		10,000
Toxaphene	Not detected	400		ug/L	1	8001-35-2		500

PCB List, Method: SW8082A, Run Date: 05/29/24 15:49, Analyst: JANB

Parameter	Result	RL	MDL	Units	Dilution	CAS#	Flags	Limits
PCB-1016	Not detected	330		ug/kg	5	12674-11-2		
PCB-1242	Not detected	330		ug/kg	5	53469-21-9		
PCB-1221	Not detected	330		ug/kg	5	11104-28-2		
PCB-1232	Not detected	330		ug/kg	5	11141-16-5		
PCB-1248	Not detected	330		ug/kg	5	12672-29-6		
PCB-1254	Not detected	330		ug/kg	5	11097-69-1		
PCB-1260	Not detected	330		ug/kg	5	11096-82-5		

### Organics - Semi-Volatiles

TCLP Semi Volatiles, Method: SW8270D, Run Date: 05/31/24 15:17, Analyst: PL

Parameter	Result	RL	MDL	Units	Dilution	CAS#	Flags	Limits
2-Methylphenol (o-Cresol)	Not detected	1,000		ug/L	10	95-48-7		200,000
3-, 4-Methylphenol (p,m-Cresol)	Not detected	1,000		ug/L	10	3/4-CRESOL		200,000
Pentachlorophenol	Not detected	1,000		ug/L	10	87-86-5		100,000
2,4,5-Trichlorophenol	Not detected	1,000		ug/L	10	95-95-4		400,000
2,4,6-Trichlorophenol	Not detected	1,000		ug/L	10	88-06-2		2,000
2,4-Dinitrotoluene	Not detected	90		ug/L	10	121-14-2		130
Hexachlorobenzene	Not detected	90		ug/L	10	118-74-1		130
Hexachlorobutadiene	Not detected	100		ug/L	10	87-68-3		500
Hexachloroethane	Not detected	100		ug/L	10	67-72-1		3,000
Nitrobenzene	Not detected	100		ug/L	10	98-95-3		2,000
Pyridine	Not detected	100		ug/L	10	110-86-1		5,000



# Analytical Laboratory Report

Lab Sample ID: S62472.01 (continued)

Sample Tag: SC-1

### Organics - Volatiles

TCLP Volatiles, Method: SW5030C/8260C, Run Date: 05/31/24 14:31, Analyst: NDK

Parameter	Result	RL	MDL	Units	Dilution	CAS#	Flags	Limits
Benzene*	Not detected	100		ug/L	100	71-43-2		500
Carbon tetrachloride*	Not detected	100		ug/L	100	56-23-5		500
Chlorobenzene*	Not detected	100		ug/L	100	108-90-7		100,000
Chloroform*	Not detected	100		ug/L	100	67-66-3		6,000
1,4-Dichlorobenzene*	Not detected	100		ug/L	100	106-46-7		7,500
1,2-Dichloroethane*	Not detected	100		ug/L	100	107-06-2		500
1,1-Dichloroethene*	Not detected	100		ug/L	100	75-35-4		700
2-Butanone (MEK)*	Not detected	1,000		ug/L	100	78-93-3		200,000
Tetrachloroethene*	Not detected	100		ug/L	100	127-18-4		700
Trichloroethene*	Not detected	100		ug/L	100	79-01-6		500
Vinyl chloride*	Not detected	100		ug/L	100	75-01-4		200

### Other / Misc.

TCLP Herbicides, Method: SW8151A, Run Date: 06/06/24 15:27, Analyst: JANB

Parameter	Result	RL	MDL	Units	Dilution	CAS#	Flags	Limits
2,4-D*	Not detected	0.2		mg/L	1	94-75-7		10.0
2,4,5-TP (Silvex)*	Not detected	0.2		mg/L	1	93-72-1		1.0

# Merit Laboratories Login Checklist

Lab Set ID:S62472

Client:ASTI (ASTI Environmental)

Project: 13059-1 Waste Char.

Submitted:05/24/2024 09:00 Login User: MMC

Attention: Tom Wackerman

Address: ASTI Environmental  
10448 Citation Drive  
Suite 100  
Brighton, MI 48116

Phone: 810-599-5463 FAX:

Email: twacker@asti-env.com

Selection	Description	Note
<b>Sample Receiving</b>		
01.	<input checked="" type="checkbox"/> Yes <input type="checkbox"/> No <input type="checkbox"/> N/A	Samples are received at 4C +/- 2C Thermometer # IR 6.0
02.	<input checked="" type="checkbox"/> Yes <input type="checkbox"/> No <input type="checkbox"/> N/A	Received on ice/ cooling process begun
03.	<input type="checkbox"/> Yes <input checked="" type="checkbox"/> No <input type="checkbox"/> N/A	Samples shipped
04.	<input type="checkbox"/> Yes <input checked="" type="checkbox"/> No <input type="checkbox"/> N/A	Samples left in 24 hr. drop box
05.	<input type="checkbox"/> Yes <input type="checkbox"/> No <input checked="" type="checkbox"/> N/A	Are there custody seals/tape or is the drop box locked
<b>Chain of Custody</b>		
06.	<input checked="" type="checkbox"/> Yes <input type="checkbox"/> No <input type="checkbox"/> N/A	COC adequately filled out
07.	<input checked="" type="checkbox"/> Yes <input type="checkbox"/> No <input type="checkbox"/> N/A	COC signed and relinquished to the lab
08.	<input checked="" type="checkbox"/> Yes <input type="checkbox"/> No <input type="checkbox"/> N/A	Sample tag on bottles match COC
09.	<input type="checkbox"/> Yes <input checked="" type="checkbox"/> No <input type="checkbox"/> N/A	Subcontracting needed? Subcontracted to:
<b>Preservation</b>		
10.	<input checked="" type="checkbox"/> Yes <input type="checkbox"/> No <input type="checkbox"/> N/A	Do sample have correct chemical preservation
11.	<input type="checkbox"/> Yes <input type="checkbox"/> No <input checked="" type="checkbox"/> N/A	Completed pH checks on preserved samples? (no VOAs)
12.	<input type="checkbox"/> Yes <input checked="" type="checkbox"/> No <input type="checkbox"/> N/A	Did any samples need to be preserved in the lab?
<b>Bottle Conditions</b>		
13.	<input checked="" type="checkbox"/> Yes <input type="checkbox"/> No <input type="checkbox"/> N/A	All bottles intact
14.	<input checked="" type="checkbox"/> Yes <input type="checkbox"/> No <input type="checkbox"/> N/A	Appropriate analytical bottles are used
15.	<input checked="" type="checkbox"/> Yes <input type="checkbox"/> No <input type="checkbox"/> N/A	Merit bottles used
16.	<input checked="" type="checkbox"/> Yes <input type="checkbox"/> No <input type="checkbox"/> N/A	Sufficient sample volume received
17.	<input type="checkbox"/> Yes <input checked="" type="checkbox"/> No <input type="checkbox"/> N/A	Samples require laboratory filtration
18.	<input checked="" type="checkbox"/> Yes <input type="checkbox"/> No <input type="checkbox"/> N/A	Samples submitted within holding time
19.	<input type="checkbox"/> Yes <input type="checkbox"/> No <input checked="" type="checkbox"/> N/A	Do water VOC or TOX bottles contain headspace

Corrective action for all exceptions is to call the client and to notify the project manager.

Client Review By: \_\_\_\_\_ Date: \_\_\_\_\_



2680 East Lansing Dr., East Lansing, MI 48823  
 Phone (517) 332-0167 Fax (517) 332-4034  
 www.meritlabs.com

C.O.C. PAGE # 1 OF 1 171236

**REPORT TO**

**CHAIN OF CUSTODY RECORD**

**INVOICE TO**

CONTACT NAME: Thomas Wackerman / Emily Manetz  
 COMPANY: ASTI Environmental  
 ADDRESS: 10448 Citation Dr  
 CITY: Brighton STATE: MI ZIP CODE: 48116  
 PHONE NO.: 810-599-5463 / 616-485-5743 CELL NO.: \_\_\_\_\_ P.O. NO.: \_\_\_\_\_  
 E-MAIL ADDRESS: twacker@asti-env.com / emanetz@asti-env.com QUOTE NO.: \_\_\_\_\_

CONTACT NAME: SAME  
 COMPANY: \_\_\_\_\_  
 ADDRESS: \_\_\_\_\_  
 CITY: \_\_\_\_\_ STATE: \_\_\_\_\_ ZIP CODE: \_\_\_\_\_  
 PHONE NO.: \_\_\_\_\_ E-MAIL ADDRESS: \_\_\_\_\_

ANALYSIS (ATTACH LIST IF MORE SPACE IS REQUIRED)

PROJECT NO./NAME: 13059-1 Waste char. SAMPLER(S) - PLEASE PRINT/SIGN NAME: Emily Manetz *EM*  
 TURNAROUND TIME REQUIRED:  1 DAY  2 DAYS  3 DAYS  STANDARD  OTHER \_\_\_\_\_  
 DELIVERABLES REQUIRED:  STD  LEVEL II  LEVEL III  LEVEL IV  EDD  OTHER \_\_\_\_\_

MATRIX W=WATER GW=GROUNDWATER WW=WASTEWATER S=SOIL L=LIQUID SD=SOLID  
 CODE: SL=SLUDGE DW=DRINKING WATER O=OIL WP=WIPE A=AIR WS=WASTE

# Containers & Preservatives

MERIT LAB NO. <small>FOR LAB USE ONLY</small>	COLLECTION		SAMPLE TAG IDENTIFICATION-DESCRIPTION	MATRIX	# OF BOTTLES	NONE	HCl	HNO <sub>3</sub>	H <sub>2</sub> SO <sub>4</sub>	NaOH	MeOH	OTHER
	DATE	TIME										
<u>62472.01</u>	<u>5/23/24</u>	<u>1620</u>	<u>SC-1</u>	<u>S</u>	<u>4</u>	<u>4</u>						

TCLP RCRA 8 Metals

Certifications  
 OHIO VAP  Drinking Water  
 DoD  NPDES  
 Project Locations  
 Detroit  New York  
 Other \_\_\_\_\_  
 Special Instructions

please hold sample following analysis in case I decide to run additional analyses

RELINQUISHED BY: EM *EM*  Sampler DATE: 5/23/24 TIME: 18:25  
 RECEIVED BY: ASTI Cold Storage DATE: 5/23/24 TIME: 18:25  
 RELINQUISHED BY: ASTI Cold Storage DATE: 5/24/24 TIME: 8:05  
 RECEIVED BY: IS DATE: 5/24/24 TIME: 8:08

RELINQUISHED BY: IS DATE: 5/24/24 TIME: 9:00  
 RECEIVED BY: M Chilcoat DATE: 5/24/24 TIME: 0900  
 SEAL NO. SEAL INTACT YES  NO  INITIALS  
 SEAL NO. SEAL INTACT YES  NO  INITIALS  
 NOTES: TEMP. ON ARRIVAL: 6.0

PLEASE NOTE: SIGNING ACKNOWLEDGES ADHERENCE TO MERIT'S SAMPLE ACCEPTANCE POLICY ON REVERSE SIDE



**ASTI ENVIRONMENTAL**  
**ENVIRONMENTAL INVESTIGATION, REMEDIATION, COMPLIANCE AND**  
**RESTORATION PROJECTS THROUGHOUT THE GREAT LAKES SINCE 1985.**

**OUR SERVICES INCLUDE:**

- **ASBESTOS, LEAD, MOLD, AND RADON ASSESSMENTS**
- **BROWNFIELD/GREYFIELD REDEVELOPMENT ASSISTANCE**
- **DEVELOPMENT INCENTIVES AND GRANT MANAGEMENT**
- **ECOLOGICAL ASSESSMENTS AND RESTORATION**
- **ENVIRONMENTAL ASSESSMENTS AND IMPACT STATEMENTS**
- **ENVIRONMENTAL OPPORTUNITIES ASSESSMENT**
- **GIS MAPPING**
- **HAZARD MITIGATION PLANNING**
- **MINING AND RECLAMATION ASSISTANCE**
- **REMEDIATION IMPLEMENTATION, OPERATION AND MAINTENANCE**
- **PHASE I ESA AND ENVIRONMENTAL DUE DILIGENCE ASSESSMENTS**
- **REGULATORY COMPLIANCE AND PERMITTING**
- **SOIL AND GROUNDWATER ASSESSMENTS**
- **SOIL AND GROUNDWATER REMEDIATION**
- **STORAGE TANK COMPLIANCE AND CLOSURE**
- **THREATENED AND ENDANGERED SPECIES SURVEYS**
- **WATERSHED AND STORMWATER MANAGEMENT PROGRAMS**
- **WETLAND DELINEATION, PERMITTING, MITIGATION AND BANKING**