

**AGREEMENT FOR
STORM WATER SYSTEM MAINTENANCE**

This Agreement is made on MARCH 4, 2020 by **GENISYS CREDIT UNION, a State of Michigan chartered financial institution, whose address is 2100 Executive Hills Boulevard, Auburn Hills, MI 48326** ("Owner"), and the CITY OF ROCHESTER HILLS (the "City"), whose address is 1000 Rochester Hills Drive, Rochester Hills, MI 48309.

WHEREAS, Owner owns and proposes to develop the Property described in attached **Exhibit A**; and

WHEREAS, the proposed development of the Property will alter the natural flow of surface and storm water drainage; and

WHEREAS, Owner has proposed, and the City has approved, a storm water drainage and detention system (the "System") comprised of storm water detention and water quality treatment facilities, storm sewer pipe, catch basins, manholes for the Property as described and depicted in the Storm Water System Plan attached as **Exhibit B**; and

WHEREAS, the parties will benefit from the proper operation, use and maintenance of the System and enter into this agreement to provide for the same.

THEREFORE, the parties agree:

1. Use of the System:

Components of the System, including any and all water conveyance, detention and water quality treatment facilities, storm sewer pipe, catch basins, manholes, shall be used solely for the purpose of conveying, detaining and treating storm and surface drainage on the property until such time as: (i) The City determines and notifies Owner or Owner's successors, grantees or assigns, in writing, that it is no longer necessary to convey, detain or treat the storm and surface drainage; and (ii) An adequate alternative for conveying, detaining and treating storm and surface drainage has been provided which is acceptable to the City and which includes the granting of any easements to the City or third parties as may be required or necessary for the alternative drainage system.

2. Maintenance:

A. Owner shall be responsible for the proper maintenance, repair and replacement of the System and all parts thereof as detailed in the Maintenance Plan attached as **Exhibit C**.

B. Proper maintenance of the System shall include, but is not limited to: (i) Removing accumulated sediment, trash and debris; (ii) Maintaining storm sewer and structures; (iii) Controlling the effects of erosion; (iv) Inspection of storm sewer structures and pipes for structural integrity; (v) Inspection and cleaning of the storm sewer and catch basins upstream from the detention system; and (vi) Any other maintenance that is reasonable and necessary to facilitate and continue the proper operation and use of the System.

3. Action by City:

If, at any time, Owner or Owner's successors, grantees or assigns neglect or fail to properly maintain the System or any part thereof, the City may notify Owner or Owner's successors, grantees or assigns. The notice shall be in writing and shall list and describe maintenance deficiencies and demand that they be corrected within thirty (30) days.

The notice shall further specify a date and place for a hearing to be held at least fourteen (14) days after the date of the notice before the City Council, or such other board or official as the City Council may designate. At the hearing, the City Council (or other designated board or official) may affirm or modify the list and description of maintenance deficiencies and, for good cause shown, may extend the time for the deficiencies to be corrected.

Thereafter, if the maintenance deficiencies are not corrected within the time allowed, the City may undertake the necessary corrective actions, and the City may maintain the System for up to one (1) year. Such maintenance of the System by the City shall not be construed to be a trespass or a taking of the Property, nor shall the City's actions vest in the public any right to enter or use the Property. Thereafter, if Owner or Owner's successors, grantees or assigns do not properly maintain the System, the City may, after providing similar written notice, schedule and hold another hearing to determine whether the City should maintain the System for another year, and subject to a similar notice, hearing and determination in subsequent years.

In the event the City determines an emergency condition caused by or relating to the System threatens the public health, safety or general welfare, the City shall have the right to immediately and without notice enter the Property and undertake appropriate corrective action.

4. Charges:

The City shall charge to the current owner of the Property the cost of maintenance or other corrective action undertaken by the City under this agreement, plus a ten percent (10%) administrative fee. If not timely paid, the City may place the charges on the City's tax roll, which charges shall be a lien on the real property and shall be collectable and enforceable in the same manner general property taxes are collected and enforced.

5. Notices:

Any notices required under this agreement shall be sent by certified mail to the address for each party set forth below, or to such other addresses as such party may notify the other parties in writing:

To Owner: GENISYS CREDIT UNION
2100 Executive Hills Blvd.
Auburn Hills, MI 48326

To the City: City Clerk
City of Rochester Hills
1000 Rochester Hills Drive
Rochester Hills, MI 48309

6. Successors and Assigns:

This agreement shall bind and inure to the benefit of the parties and their respective successors, grantees and assigns. The benefits, burdens, rights, obligations and responsibilities hereunder shall run with the land and shall bind all current and future owners of the Property and any divisions thereof.

7. Recording of Agreement:

This agreement shall be recorded at the Oakland County Register of Deeds.

Genisys Credit Union

By: Jaqueline Buchanan
Jacqueline Buchanan
Its: President and CEO

STATE OF MICHIGAN
COUNTY OF OAKLAND

This agreement was acknowledged before me on March 4, 2020 by Jaqueline Buchanan, President and Chief Executive Officer of Genisys Credit Union, a State of Michigan chartered financial institution, on its behalf.

Kim Hudalla
Notary public
Oakland County, Michigan



My commission expires: 11-15-2020

CITY OF ROCHESTER HILLS

By: _____
Bryan Barnett, Mayor

By: _____
Tina Barton, Clerk

STATE OF MICHIGAN
COUNTY OF OAKLAND

This agreement was acknowledged before me on _____, 2020, by Bryan Barnett, Mayor, and Tina Barton, Clerk, of the City of Rochester Hills, on behalf of the City.

Notary public
_____ County, Michigan

My commission expires: _____

Drafted By:
Michael D.P. Burwell
Bowen Radabaugh & Milton, P.C.
100 E. Big Beaver Rd., Suite 350
Troy, MI 4808

When Recorded Return to:
City Clerk
City of Rochester Hills
1000 Rochester Hills Drive
Rochester Hills, MI 48309

John Steran
Approved 4/3/20

EXHIBIT A
LEGAL DESCRIPTION

LEGAL DESCRIPTION

(AS SURVEYED BY PEA, INC)

A parcel of land situated in a part of the Southwest 1/4 of Section 23, T.03N., R.11E., City of Rochester Hills, Oakland County, Michigan, being more particularly described as follows:

Commencing at the West 1/4 Corner of said Section 23, thence North 01 degrees 50 minutes 00 seconds West 2.36 feet; thence North 85 degrees 52 minutes 55 seconds East 66.05 feet to the east line of Rochester Road (width varies); thence South 01 degrees 48 minutes 43 seconds East 769.32 feet along said east line of Rochester Road to the south line of Eddington Blvd. (86 feet wide) and the POINT OF BEGINNING; thence along said south line North 88 degrees 11 Minutes 17 seconds East 379.03 feet; thence South 01 degrees 48 minutes 43 seconds East 200.00 feet; thence South 88 degrees 11 minutes 17 seconds West 379.03 feet to the east line of said Rochester Road; thence along said east line North 01 degrees 48 minutes 43 Seconds West 200.00 feet to the POINT OF BEGINNING. Containing 1.74± acres

Parcel # 15-23-300-043

Jenny M.
Approved 5/19/20

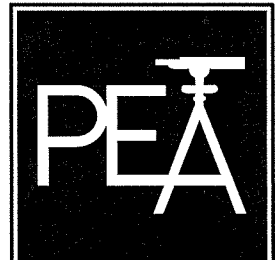

PEA, Inc.

2430 Rochester Ct, Ste 100
Troy, MI 48063-1872
t: 248.689.9090
f: 248.689.1044
www.peainc.com

CLIENT: GENISYS CREDIT UNION 2100 EXECUTIVE HILLS BLVD AUBURN HILLS, MICHIGAN 48326	SCALE: N/A	JOB No: 2019-065
	DATE: 05-12-20	DWG. No: 1 of 3

EXHIBIT B STORM WATER SYSTEM PLAN

W 1/4 CORNER
SECTION 23
T. 3N., R. 11E
CITY OF ROCHESTER HILLS
OAKLAND COUNTY,
MICHIGAN

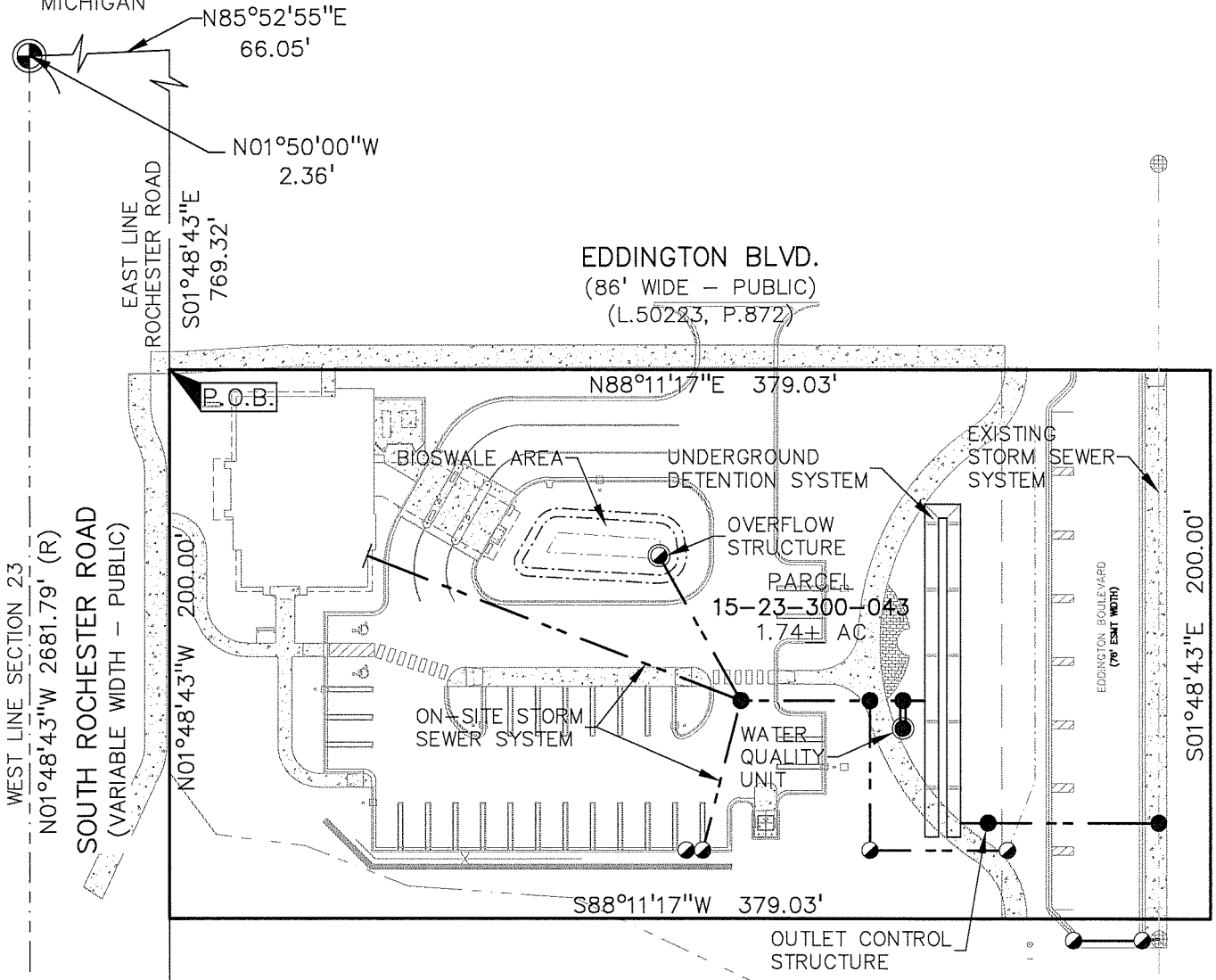

SW CORNER
SECTION 23
T. 3N., R. 11E
CITY OF ROCHESTER HILLS
OAKLAND CO, MICHIGAN

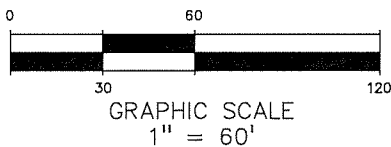

Approved 5/19/20
ARS

LEGEND

- EXISTING CATCH BASIN
- CATCH BASIN
- MANHOLE
- WATER QUALITY UNIT

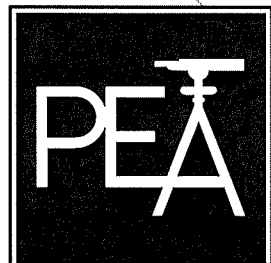

PEA, Inc.

2430 Rochester Ct, Ste 100
Troy, MI 48063-1872
t: 248.689.9090
f: 248.689.1044
www.peainc.com

CLIENT:
GENISYS CREDIT UNION
2100 EXECUTIVE HILLS BLVD
AUBURN HILLS, MICHIGAN 48326

SCALE: 1" = 60'

JOB No: 2019-065

DATE: 05-12-20

DWG. No: 2 of 3

OPERATIONS AND MAINTENANCE MANUAL

Genisys Credit Union
Stormwater Maintenance Plan
Rochester Hills, Michigan

Property Owner: Genisys Credit Union
2100 Executive Hills Blvd.
Auburn Hills, MI 48326

OPERATION AND MAINTENANCE MANUAL

INTRODUCTION:

This manual identifies the ownership, operation and maintenance responsibilities for all storm water management systems including the underground detention system, underground, storm sewer system, outlet control structures, mechanical pre-treatment devices and bioswales as incorporated into and detailed on the approved Construction Plans as prepared by Professional Engineering Associates, Inc. In order to comply with the local best management practices (BMP) and requirements, this manual should serve as a minimum performance standard. This manual should be retained intact and read in its entirety by all parties responsible for the operations and maintenance of the on-site BMP's.

OWNER:

Genisys Credit Union
2100 Executive Hills Boulevard
Auburn Hills, MI 48326

PROPERTY INFORMATION:

This Operations and Maintenance Manual covers the storm water systems located on the property as described in Exhibit "A" to this storm water system maintenance agreement dated March 4, 2020.

TAX ITEM NO. 15-23-300-043

STORMWATER MANTENANCE EXHIBIT:

Exhibit "B" of the Storm Water Maintenance Agreement is the Storm Water System Plan which provides a clear presentation of all components of the storm water system. This system is subject to the long-term operation and maintenance responsibilities detailed in this manual. The system includes:

- Storm sewer pipes
- Stormwater detention chambers
- Storm sewer structures (manholes, inlets, catch basins, etc.)
- Outlet control structures
- Pre-Treatment Devices ConTech (CDS-2015-4C)
- Bioswale

*JK ARS
6/5/20*

INSPECTIONS:

The frequency of system inspections outlined in the manual and attached exhibits should be considered the minimum, if no events warrant additional inspections. The frequency of inspection should be fine-tuned over time as system specific conditions are better known and the rate at which certain maintenance operations need to be performed is better understood. Maintenance Inspection Checklists are provided for each of the BMP's in this system. Inspections should be performed by personnel responsible for maintenance and may need to be certified for confined space entry, depending on the component being inspected. Operation of the detention system, outlet control structures and pre-treatment devices may need to be inspected by a practicing civil engineer familiar with their operation.

Records of all routine inspections and any work performed on the system for maintenance, repair or replacement should be maintained by the owner and kept for a minimum of ten (10) years. A copy of all records should be provided to the City of Rochester Hills Engineering Division. The records should include this manual, all inspection sheets, approved construction plans and as-built documents, a maintenance log of work performed to the system(s) and contact information for the system inspector, civil engineer, landscape architect, geotechnical engineer and contractor involved with the system.

STORM WATER SYSTEM MAINTENANCE:

Regular Inspection and maintenance of BMP's are necessary if these facilities are to consistently perform up to expectations. Stormwater systems are expected to perform quality and quantity control functions as long as the land use they serve exists. Failure to maintain these systems can create the following adverse impacts:

- Increased pollutants to surrounding surface water features
- Potential loss of life or property resulting from catastrophic failure of the facility
- Aesthetic or nuisance conditions, such as mosquitoes or reduced property values due to a degraded facility appearance.

Most of these impacts can be avoided through proper and timely inspection and maintenance. A major concern associated with these impacts is the general public's expectations related to the quality of life provided, in part, by construction of these systems. Inadequate maintenance means the general public may have a false sense of security. The most common cause of stormwater system failure is the lack of adequate and proper operation, inspection, maintenance and management.

Good design and construction can reduce subsequent maintenance needs and costs, but they can not eliminate the need for maintenance altogether. Maintenance requires a long-term commitment of time, money, personnel and equipment. Monitoring the overall performance of the stormwater management system is a major aspect of any maintenance program.

GENERAL MAINTENANCE ITEMS:

Parking Lot Sweeping:

Routine sweeping of all paved surfaces provides a more attractive appearance and removes accumulations of sediment and trash that tend to migrate into stormwater management systems during rainfall events. Parking lot sweeping should be performed quarterly or as necessary to limit sediment and trash build-up.

Grass Mowing and Maintenance:

Mowing requirements at a facility should be designed to the specific site conditions, grass types and seasonal variations in climate. Requirement for grasses in bioswales will vary see the applicable section below. Grassed areas require periodic fertilizing, de-thatching and soil conditioning in order to maintain healthy growth. Provisions will need to be made to reseed and reestablish grass cover in areas damaged by sediment accumulation, stormwater flow, erosion or other causes. Dead turf will need to be replaced after being discovered. Inspection of the grass areas and other landscaping features should be made annually.

Trash and Debris Removal:

Removal of trash and debris from all areas of the property should be performed monthly. Removal of these items will prevent damage to vegetated areas and eliminate their potential to inhibit the operation of any of the stormwater management systems. Sediment, debris and trash that are removed and collected should be disposed of according to local, State and Federal regulations at suitable disposal and/or recycling centers.

Stormwater System Maintenance Items:

The following narratives give an overview of the maintenance requirements of the different components of the stormwater system. The inspection checklists attached to this report offer a more complete listing of what should be inspected, when inspection should occur and the likely frequency of maintenance activities.

Storm Sewer, Chambers and Structures:

Catch basins, inlets, manholes, outlet control structures, detention chambers and storm sewer pipes should be inspected to check for sediment accumulation and clogging, floatable debris, dead vegetation, etc. The structures and sewers should also be observed during a wet weather event to ensure their proper operation. Accumulated sediment and debris should be removed on an annual basis or as needed based on observed conditions. Structural repairs or maintenance should occur as needed based on observed conditions such as cracks, spalling, joint failure, leakage, misalignment or settlement of structures. A civil engineer should be retained if problems are thought to exist.

Bioswales:

The bioswales should be kept free of dead leaves and vegetation, trash, debris or any other foreign matter that would inhibit infiltration of runoff. The swale outlet control structure should be checked for structural integrity as mentioned above for the storm sewer structures, and any visible signs of erosion or flow bypassing the structure. The bioswale itself will trap sediment under normal conditions, so the amount of sediment should be monitored over time, and removed when the accumulated depth reaches 3"-4" total. The planted vegetation within the bioswale should conform to that shown on the construction plans, and any invasive species should be removed from the swale. Regular lawn fertilizing and mowing should not occur within the bioswale at all. Mowing should cease at the top of bank for the bioswale. The operation of the bioswale and the outlet control structure should be observed during a wet weather event to ensure the proper functioning of the swale. A civil engineer should be retained if problems are thought to exist. The vegetation should be inspected for healthy growth by a landscape architect if the inspection personnel are not familiar with the specific plantings inside the basins.

Stormwater Pre-Treatment Devices:

Refer to the attached maintenance manuals from the manufacturer for all inspection and maintenance requirements for the pre-treatment structures.

The following pages include inspection checklists for the various devices and components listed above as well as the manufacture's manuals for the stormwater pre-treatment structures.

EXHIBIT C

STORM WATER MANAGEMENT SYSTEM – PERMANENT MAINTENANCE

DATE/TIME OF INSPECTION: _____

INSPECTOR: _____

STORMWATER MANAGEMENT SYSTEM MAINTENANCE TASKS AND SCHEDULE

MAINTENANCE ACTIVITIES	SYSTEM COMPONENTS						FREQUENCY
	Storm Collection System (Sewers, Swales, Catch Basins, Manholes)	Manufactured Treatment System	Underground Detention System	Flow Restrictor & Outlet Pipe Structure	Bioswale Plantings	Pavement Areas	
MONITORING/INSPECTION							
Inspect for sediment accumulation/clogging	X	X	X	X	X	X	Annually
Inspect for floatables, dead vegetation and debris	X	X	X	X	X	X	Annually & After Major Events
Inspect for erosion and integrity of system	X				X	X	Annually & After Major Events
Inspect all components during wet weather and compare to as-built plans	X	X	X	X		X	Annually
Ensure maintenance access remain open/clear	X	X	X	X	X	X	Annually
PREVENTIVE MAINTENANCE							
Remove accumulated sediment	X	X	X	X	X	X	As Needed (see note below)
Remove floatables, dead vegetation and debris	X	X	X	X	X	X	As Needed
Sweeping of pavement surfaces (streets and parking areas)						X	As Needed
REMEDIAL ACTIONS							
Repair/stabilize areas of erosion	X				X	X	As Needed
Replace dead plantings & reseed bare areas	X				X		As Needed
Structural repairs	X	X	X	X		X	As Needed
Make adjustments/repairs to ensure proper functioning	X	X	X	X	X	X	As Needed

NOTE: Manufactured treatment system and underground detention system to be cleaned according to the manufacturer's recommendations; at a minimum, whenever sediments accumulate to a depth of 6–12 inches, or if sediment resuspension is observed.

SUMMARY:

INSPECTORS REMARKS: _____

OVERALL CONDITION OF FACILITY: _____

RECOMMENDED ACTIONS NEEDED: _____

DATES ANY MAINTENANCE MUST BE COMPLETED BY: _____

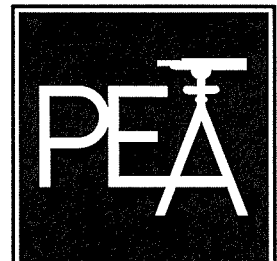

PEA, Inc.

2430 Rochester Ct, Ste 100
 Troy, MI 48063-1872
 t: 248.689.9090
 f: 248.689.1044
 www.peainc.com

CLIENT: **GENISYS CREDIT UNION**
 2100 EXECUTIVE HILLS BLVD
 AUBURN HILLS, MICHIGAN 48326

SCALE: N/A
 DATE: 05-12-20

JOB No: 2019-065
 DWG. No: 3 of 3

CDS Guide

Operation, Design, Performance and Maintenance

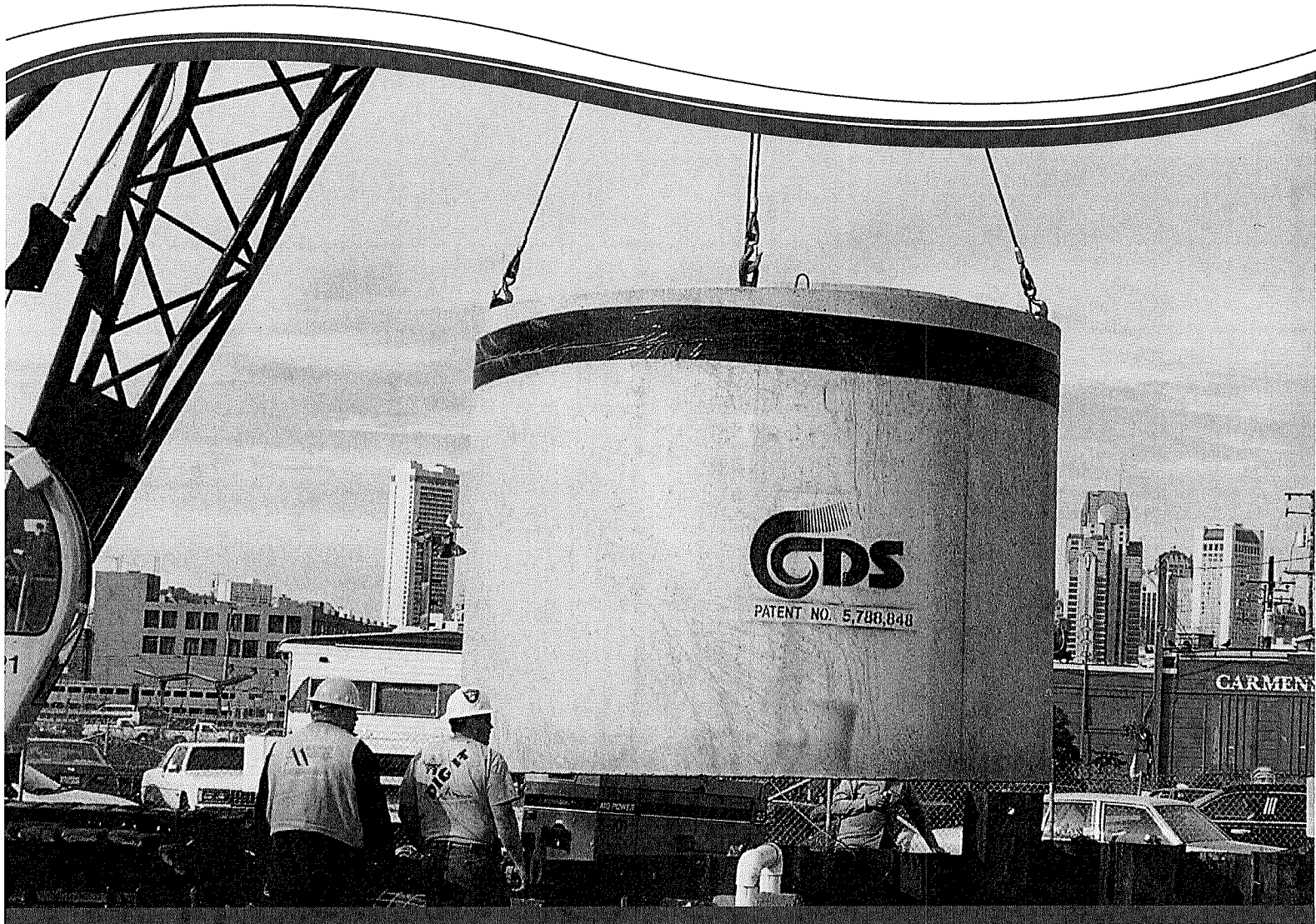

CDS®

Using patented continuous deflective separation technology, the CDS system screens, separates and traps debris, sediment, and oil and grease from stormwater runoff. The indirect screening capability of the system allows for 100% removal of floatables and neutrally buoyant material without blinding. Flow and screening controls physically separate captured solids, and minimize the re-suspension and release of previously trapped pollutants. Inline units can treat up to 6 cfs, and internally bypass flows in excess of 50 cfs (1416 L/s). Available precast or cast-in-place, offline units can treat flows from 1 to 300 cfs (28.3 to 8495 L/s). The pollutant removal capacity of the CDS system has been proven in lab and field testing.

Operation Overview

Stormwater enters the diversion chamber where the diversion weir guides the flow into the unit's separation chamber and pollutants are removed from the flow. All flows up to the system's treatment design capacity enter the separation chamber and are treated.

Swirl concentration and screen deflection force floatables and solids to the center of the separation chamber where 100% of floatables and neutrally buoyant debris larger than the screen apertures are trapped.

Stormwater then moves through the separation screen, under the oil baffle and exits the system. The separation screen remains clog free due to continuous deflection.

During the flow events exceeding the treatment design capacity, the diversion weir bypasses excessive flows around the separation chamber, so captured pollutants are retained in the separation cylinder.

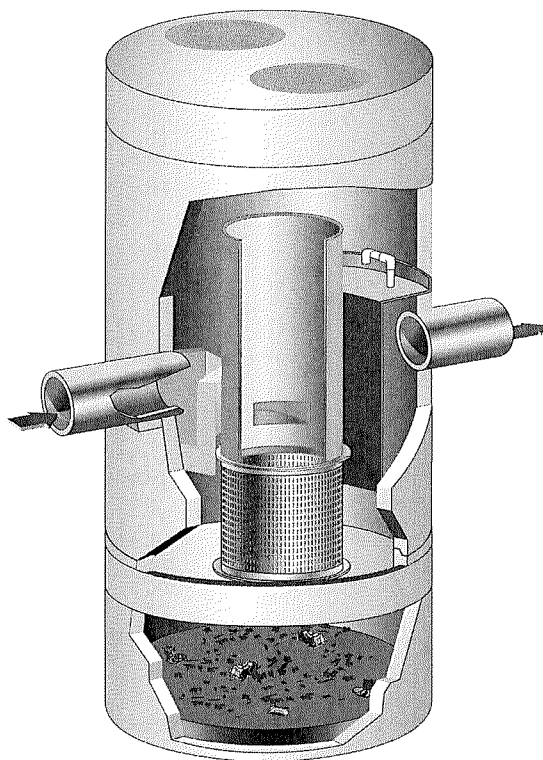

Design Basics

There are three primary methods of sizing a CDS system. The Water Quality Flow Rate Method determines which model size provides the desired removal efficiency at a given flow rate for a defined particle size. The Rational Rainfall Method™ or the Probabilistic Method is used when a specific removal efficiency of the net annual sediment load is required.

Typically in the United States, CDS systems are designed to achieve an 80% annual solids load reduction based on lab generated performance curves for a gradation with an average particle size (d50) of 125 microns (μm). For some regulatory environments, CDS systems can also be designed to achieve an 80% annual solids load reduction based on an average particle size (d50) of 75 microns (μm) or 50 microns (μm).

Water Quality Flow Rate Method

In some cases, regulations require that a specific treatment rate, often referred to as the water quality design flow (WQQ), be treated. This WQQ represents the peak flow rate from either an event with a specific recurrence interval, e.g. the six-month storm, or a water quality depth, e.g. 1/2-inch (13 mm) of rainfall.

The CDS is designed to treat all flows up to the WQQ. At influent rates higher than the WQQ, the diversion weir will direct most flow exceeding the WQQ around the separation chamber. This allows removal efficiency to remain relatively constant in the separation chamber and eliminates the risk of washout during bypass flows regardless of influent flow rates.

Treatment flow rates are defined as the rate at which the CDS will remove a specific gradation of sediment at a specific removal efficiency. Therefore the treatment flow rate is variable, based on the gradation and removal efficiency specified by the design engineer.

Rational Rainfall Method™

Differences in local climate, topography and scale make every site hydraulically unique. It is important to take these factors into consideration when estimating the long-term performance of any stormwater treatment system. The Rational Rainfall Method combines site-specific information with laboratory generated performance data, and local historical precipitation records to estimate removal efficiencies as accurately as possible.

Short duration rain gauge records from across the United States and Canada were analyzed to determine the percent of the total annual rainfall that fell at a range of intensities. US stations' depths were totaled every 15 minutes, or hourly, and recorded in 0.01-inch increments. Depths were recorded hourly with 1-mm resolution at Canadian stations. One trend was consistent at all sites; the vast majority of precipitation fell at low intensities and high intensity storms contributed relatively little to the total annual depth.

These intensities, along with the total drainage area and runoff coefficient for each specific site, are translated into flow rates using the Rational Rainfall Method. Since most sites are relatively small and highly impervious, the Rational Rainfall Method is appropriate. Based on the runoff flow rates calculated for each intensity, operating rates within a proposed CDS system are

determined. Performance efficiency curve determined from full scale laboratory tests on defined sediment PSDs is applied to calculate solids removal efficiency. The relative removal efficiency at each operating rate is added to produce a net annual pollutant removal efficiency estimate.

Probabilistic Rational Method

The Probabilistic Rational Method is a sizing program Contech developed to estimate a net annual sediment load reduction for a particular CDS model based on site size, site runoff coefficient, regional rainfall intensity distribution, and anticipated pollutant characteristics.

The Probabilistic Method is an extension of the Rational Method used to estimate peak discharge rates generated by storm events of varying statistical return frequencies (e.g. 2-year storm event). Under the Rational Method, an adjustment factor is used to adjust the runoff coefficient estimated for the 10-year event, correlating a known hydrologic parameter with the target storm event. The rainfall intensities vary depending on the return frequency of the storm event under consideration. In general, these two frequency dependent parameters (rainfall intensity and runoff coefficient) increase as the return frequency increases while the drainage area remains constant.

These intensities, along with the total drainage area and runoff coefficient for each specific site, are translated into flow rates using the Rational Method. Since most sites are relatively small and highly impervious, the Rational Method is appropriate. Based on the runoff flow rates calculated for each intensity, operating rates within a proposed CDS are determined. Performance efficiency curve on defined sediment PSDs is applied to calculate solids removal efficiency. The relative removal efficiency at each operating rate is added to produce a net annual pollutant removal efficiency estimate.

Treatment Flow Rate

The inlet throat area is sized to ensure that the WQQ passes through the separation chamber at a water surface elevation equal to the crest of the diversion weir. The diversion weir bypasses excessive flows around the separation chamber, thus preventing re-suspension or re-entrainment of previously captured particles.

Hydraulic Capacity

The hydraulic capacity of a CDS system is determined by the length and height of the diversion weir and by the maximum allowable head in the system. Typical configurations allow hydraulic capacities of up to ten times the treatment flow rate. The crest of the diversion weir may be lowered and the inlet throat may be widened to increase the capacity of the system at a given water surface elevation. The unit is designed to meet project specific hydraulic requirements.

Performance

Full-Scale Laboratory Test Results

A full-scale CDS system (Model CDS2020-5B) was tested at the facility of University of Florida, Gainesville, FL. This CDS unit was evaluated under controlled laboratory conditions of influent flow rate and addition of sediment.

Two different gradations of silica sand material (UF Sediment & OK-110) were used in the CDS performance evaluation. The particle size distributions (PSDs) of the test materials were analyzed using standard method "Gradation ASTM D-422 "Standard Test Method for Particle-Size Analysis of Soils" by a certified laboratory.

UF Sediment is a mixture of three different products produced by the U.S. Silica Company: "Sil-Co-Sil 106", "#1 DRY" and "20/40 Oil Frac". Particle size distribution analysis shows that the UF Sediment has a very fine gradation ($d_{50} = 20$ to $30 \mu\text{m}$) covering a wide size range (Coefficient of Uniformity, C averaged at 10.6). In comparison with the hypothetical TSS gradation specified in the NJDEP (New Jersey Department of Environmental Protection) and NJCAT (New Jersey Corporation for Advanced Technology) protocol for lab testing, the UF Sediment covers a similar range of particle size but with a finer d_{50} (d_{50} for NJDEP is approximately $50 \mu\text{m}$) (NJDEP, 2003).

The OK-110 silica sand is a commercial product of U.S. Silica Sand. The particle size distribution analysis of this material, also included in Figure 1, shows that 99.9% of the OK-110 sand is finer than 250 microns, with a mean particle size (d_{50}) of 106 microns. The PSDs for the test material are shown in Figure 1.

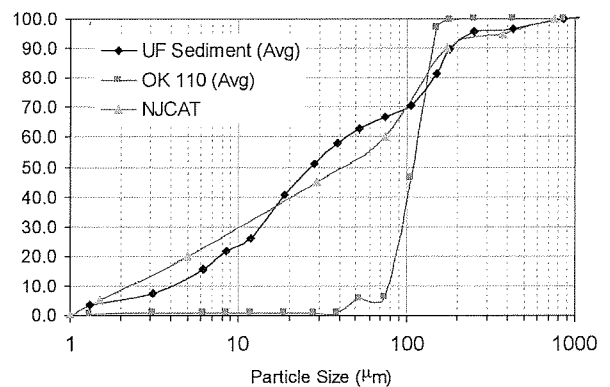

Figure 1. Particle size distributions

Tests were conducted to quantify the performance of a specific CDS unit (1.1 cfs (31.3-L/s) design capacity) at various flow rates, ranging from 1% up to 125% of the treatment design capacity of the unit, using the 2400 micron screen. All tests were conducted with controlled influent concentrations of approximately 200 mg/L. Effluent samples were taken at equal time intervals across the entire duration of each test run. These samples were then processed with a Dekaport Cone sample splitter to obtain representative sub-samples for Suspended Sediment Concentration (SSC) testing using ASTM D3977-97 "Standard Test Methods for Determining Sediment Concentration in Water Samples", and particle size distribution analysis.

Results and Modeling

Based on the data from the University of Florida, a performance model was developed for the CDS system. A regression analysis was used to develop a fitting curve representative of the scattered data points at various design flow rates. This model, which demonstrated good agreement with the laboratory data, can then be used to predict CDS system performance with respect

to SSC removal for any particle size gradation, assuming the particles are inorganic sandy-silt. Figure 2 shows CDS predictive performance for two typical particle size gradations (NJCAT gradation and OK-110 sand) as a function of operating rate.

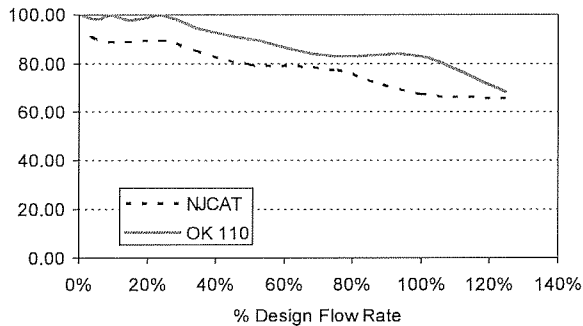

Figure 2. CDS stormwater treatment predictive performance for various particle gradations as a function of operating rate.

Many regulatory jurisdictions set a performance standard for hydrodynamic devices by stating that the devices shall be capable of achieving an 80% removal efficiency for particles having a mean particle size (d_{50}) of 125 microns (e.g. Washington State Department of Ecology — WASDOE - 2008). The model can be used to calculate the expected performance of such a PSD (shown in Figure 3). The model indicates (Figure 4) that the CDS system with 2400 micron screen achieves approximately 80% removal at the design (100%) flow rate, for this particle size distribution ($d_{50} = 125 \mu\text{m}$).

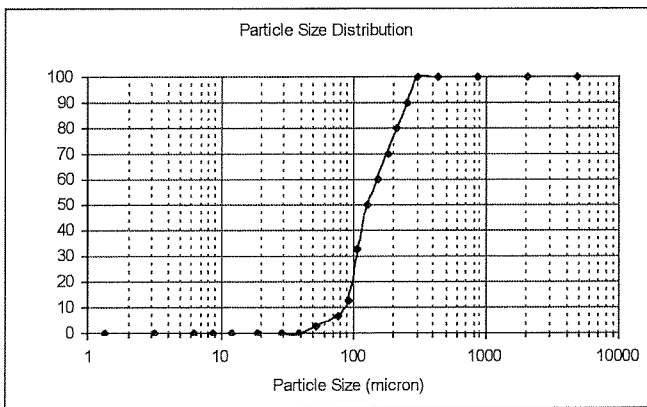

Figure 3. WASDOE PSD

CDS Unit Performance for Ecology PSD
 $d_{50} = 125 \mu\text{m}$

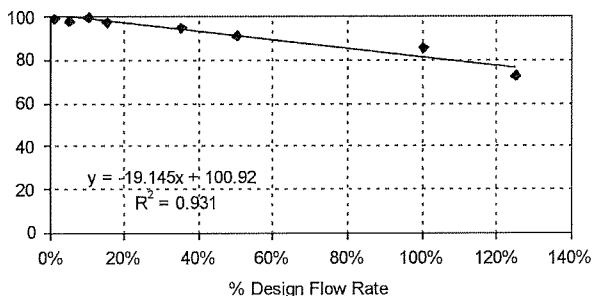

Figure 4. Modeled performance for WASDOE PSD.

Maintenance

The CDS system should be inspected at regular intervals and maintained when necessary to ensure optimum performance. The rate at which the system collects pollutants will depend more heavily on site activities than the size of the unit. For example, unstable soils or heavy winter sanding will cause the grit chamber to fill more quickly but regular sweeping of paved surfaces will slow accumulation.

Inspection

Inspection is the key to effective maintenance and is easily performed. Pollutant transport and deposition may vary from year to year and regular inspections will help ensure that the system is cleaned out at the appropriate time. At a minimum, inspections should be performed twice per year (e.g. spring and fall) however more frequent inspections may be necessary in climates where winter sanding operations may lead to rapid accumulations, or in equipment washdown areas. Installations should also be inspected more frequently where excessive amounts of trash are expected.

The visual inspection should ascertain that the system components are in working order and that there are no blockages or obstructions in the inlet and separation screen. The inspection should also quantify the accumulation of hydrocarbons, trash, and sediment in the system. Measuring pollutant accumulation can be done with a calibrated dipstick, tape measure or other measuring instrument. If absorbent material is used for enhanced removal of hydrocarbons, the level of discoloration of the sorbent material should also be identified



during inspection. It is useful and often required as part of an operating permit to keep a record of each inspection. A simple form for doing so is provided.

Access to the CDS unit is typically achieved through two manhole access covers. One opening allows for inspection and cleanout of the separation chamber (cylinder and screen) and isolated sump. The other allows for inspection and cleanout of sediment captured and retained outside the screen. For deep units, a single manhole access point would allow both sump cleanout and access outside the screen.

The CDS system should be cleaned when the level of sediment has reached 75% of capacity in the isolated sump or when an appreciable level of hydrocarbons and trash has accumulated. If absorbent material is used, it should be replaced when significant discoloration has occurred. Performance will not be impacted until 100% of the sump capacity is exceeded however it is recommended that the system be cleaned prior to that for easier removal of sediment. The level of sediment is easily determined by measuring from finished grade down to the top of the sediment pile. To avoid underestimating the level of sediment in the chamber, the measuring device must be lowered to the top of the sediment pile carefully. Particles at the top of the pile typically offer less resistance to the end of the rod than consolidated particles toward the bottom of the pile. Once this measurement is recorded, it should be compared to the as-built drawing for the unit to determine whether the height of the sediment pile off the bottom of the sump floor exceeds 75% of the total height of isolated sump.

Cleaning

Cleaning of a CDS system should be done during dry weather conditions when no flow is entering the system. The use of a vacuum truck is generally the most effective and convenient method of removing pollutants from the system. Simply remove the manhole covers and insert the vacuum hose into the sump. The system should be completely drained down and the sump fully evacuated of sediment. The area outside the screen should also be cleaned out if pollutant build-up exists in this area.

In installations where the risk of petroleum spills is small, liquid contaminants may not accumulate as quickly as sediment. However, the system should be cleaned out immediately in the event of an oil or gasoline spill. Motor oil and other hydrocarbons that accumulate on a more routine basis should be removed when an appreciable layer has been captured. To remove these pollutants, it may be preferable to use absorbent pads since they are usually less expensive to dispose than the oil/water emulsion that may be created by vacuuming the oily layer. Trash and debris can be netted out to separate it from the other pollutants. The screen should be cleaned to ensure it is free of trash and debris.

Manhole covers should be securely seated following cleaning activities to prevent leakage of runoff into the system from above and also to ensure that proper safety precautions have been followed. Confined space entry procedures need to be followed if physical access is required. Disposal of all material removed from the CDS system should be done in accordance with local regulations. In many jurisdictions, disposal of the sediments may be handled in the same manner as the disposal of sediments removed from catch basins or deep sump manholes. Check your local regulations for specific requirements on disposal.

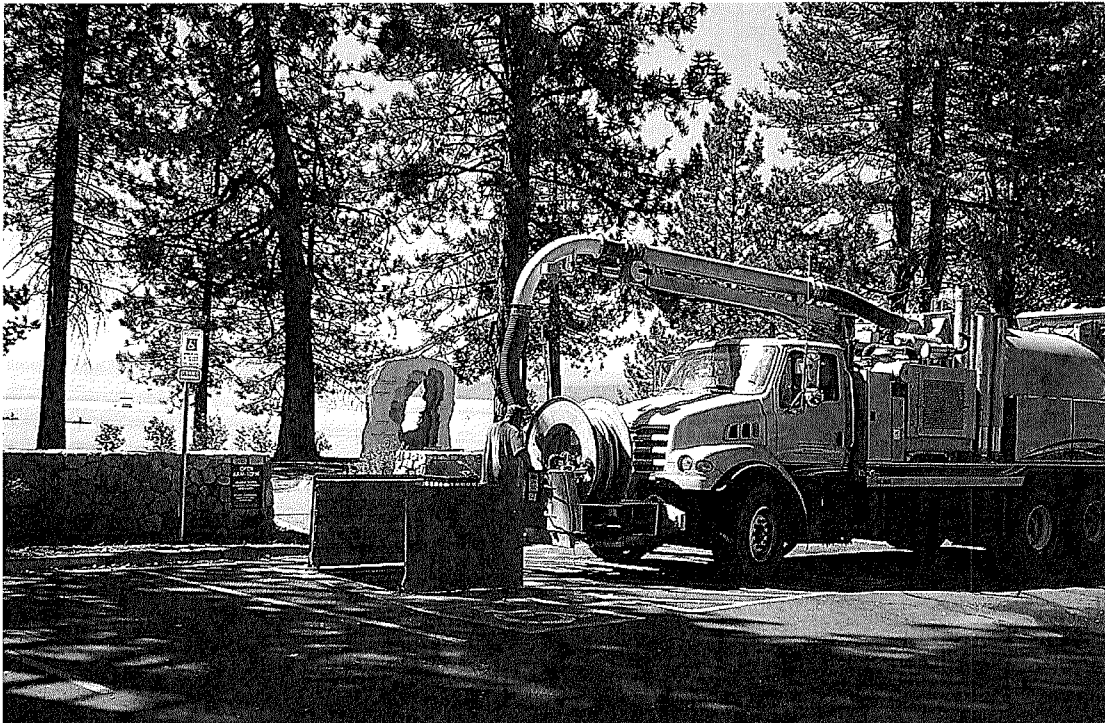

CDS Model	Diameter		Distance from Water Surface to Top of Sediment Pile		Sediment Storage Capacity	
	ft	m	ft	m	yd ³	m ³
CDS2015-4	4	1.2	3.0	0.9	0.5	0.4
CDS2015	5	1.5	3.0	0.9	1.3	1.0
CDS2020	5	1.5	3.5	1.1	1.3	1.0
CDS2025	5	1.5	4.0	1.2	1.3	1.0
CDS3020	6	1.8	4.0	1.2	2.1	1.6
CDS3030	6	1.8	4.6	1.4	2.1	1.6
CDS3035	6	1.8	5.0	1.5	2.1	1.6
CDS4030	8	2.4	4.6	1.4	5.6	4.3
CDS4040	8	2.4	5.7	1.7	5.6	4.3
CDS4045	8	2.4	6.2	1.9	5.6	4.3

Table 1: CDS Maintenance Indicators and Sediment Storage Capacities

Note: To avoid underestimating the volume of sediment in the chamber, carefully lower the measuring device to the top of the sediment pile. Finer silty particles at the top of the pile may be more difficult to feel with a measuring stick. These finer particles typically offer less resistance to the end of the rod than larger particles toward the bottom of the pile.

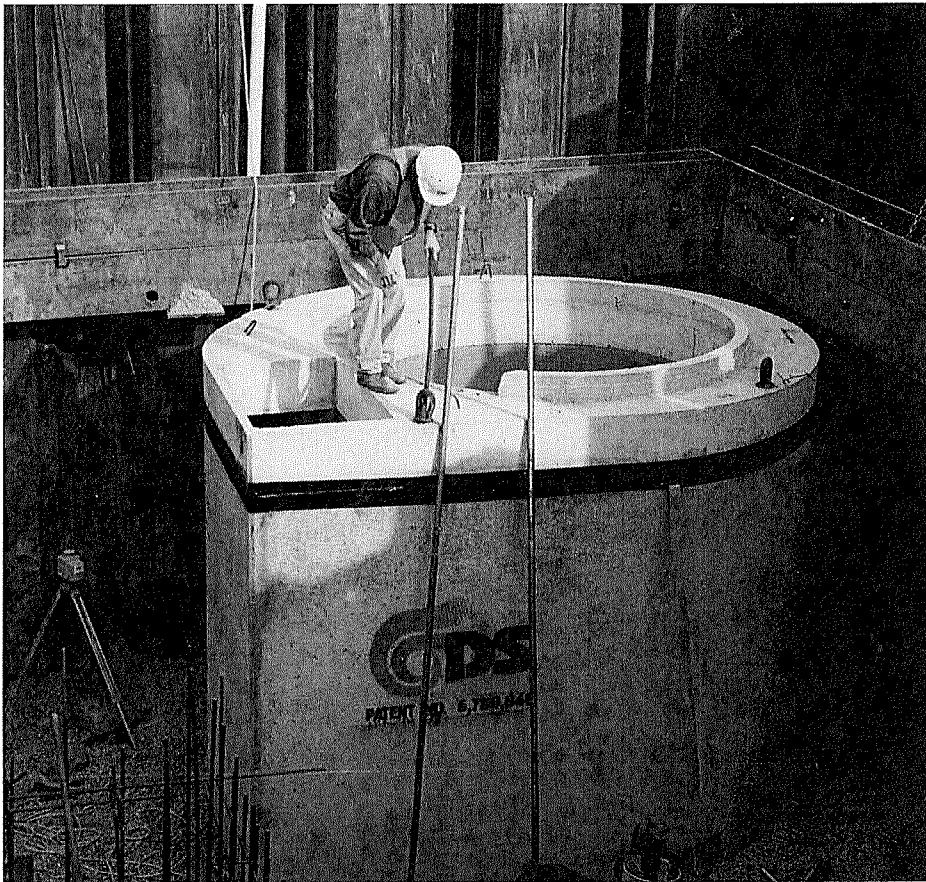

Support

- Drawings and specifications are available at www.ContechES.com/urbangreen.
- Site-specific design support is available from our engineers.

CONTECH[®]
ENGINEERED SOLUTIONS

800.925.5240

www.ContechES.com/urbangreen

©2013 Contech Engineered Solutions LLC

Contech Engineered Solutions provides site solutions for the civil engineering industry. Contech's portfolio includes bridges, drainage, sanitary sewer, stormwater, earth stabilization and wastewater products. For information on other Contech division offerings, visit www.ContechES.com or call 800.338.1122

NOTHING IN THIS CATALOG SHOULD BE CONSTRUED AS AN EXPRESSED WARRANTY OR AN IMPLIED WARRANTY OF MERCHANTABILITY OR FITNESS FOR ANY PARTICULAR PURPOSE. SEE THE Contech STANDARD CONDITION OF SALES (VIEWABLE AT www.ContechES.com/COS) FOR APPLICABLE WARRANTIES AND OTHER IMPORTANT INFORMATION.

The product(s) described may be protected by one or more of the following US patents: 5,322,629; 5,624,576; 5,707,527; 5,759,415; 5,788,848; 5,985,157; 6,027,639; 6,350,374; 6,406,218; 6,641,720; 6,511,595; 6,649,048; 6,991,114; 6,998,038; 7,186,058; 7,296,692; 7,297,266; related foreign patents or other patents pending.